

NICOLAS TERRY
P R E S E N T S

ORIGAMI ESSENCE

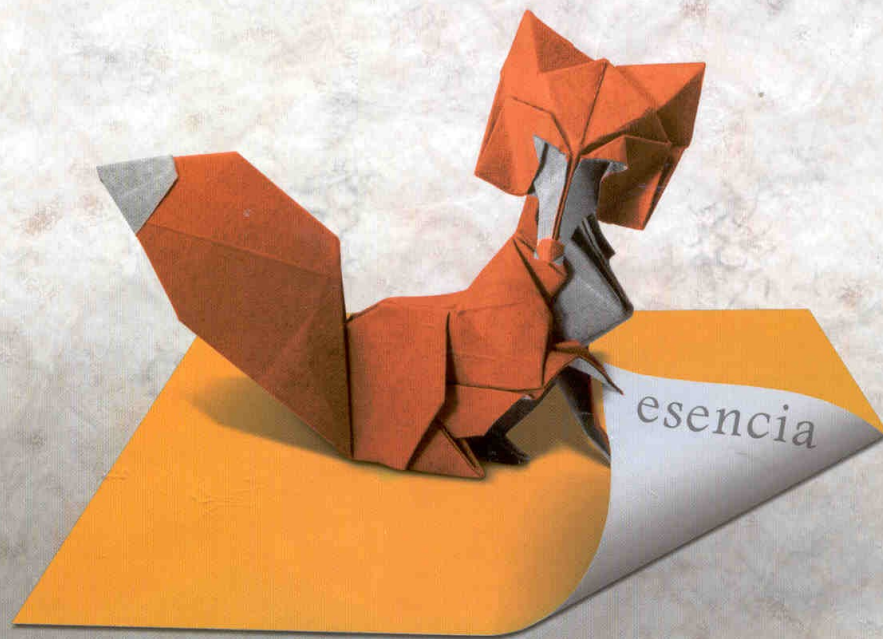

Román Díaz

PANDA

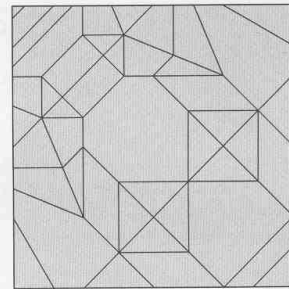
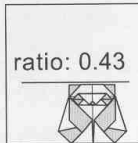
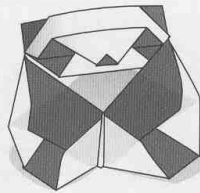

Nivel 1
 Papel favorito: Tant negro pintado de blanco en una cara. Kami blanco y negro.
 Tamaño recomendado: 15 a 20 cm.
 Comentarios: doblar en seco.

Level 1
 Favorite paper: black Tant paper, painted white on one side or black and white kami.
 Recommended size: 15 to 20 cm.
 Comments: dry-fold.

1. Color oscuro hacia arriba.
Dark side up.
2. Doblar en valle.
Valley-fold.
3. Doblar en valle.
Valley-fold.
- 4.
5. Doblar en valle.
Valley-fold.
6. Abrir y aplastar.
Squash-fold.
7. Doblar en valle permitiendo que rote una punta.
Valley-fold allowing a point to swing out.
- 8.
9. Marcar.
Crease.
10. Marcar a través de todas las capas.
Crease through all layers.
11. Doblar en valle incorporando dos dobleces revertidos en el medio.
Valley-fold incorporating two reverse folds in the center.
12. Doblar en valle dos puntas.
Valley-fold two points.

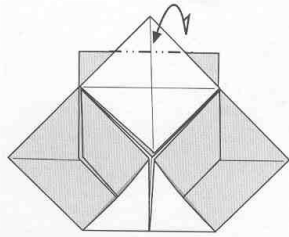

13. Marcar.
Crease.

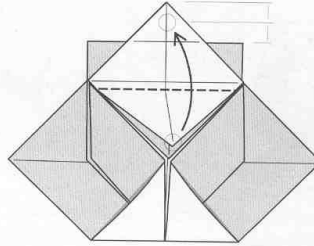

14. Doblar en valle según esta referencia aproximada.
Valley-fold with this approximate reference.

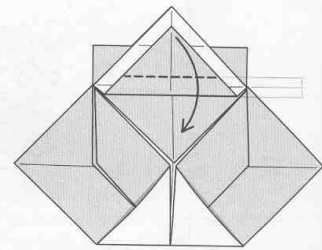

15. Doblar en valle según esta referencia aproximada.
Valley-fold with this approximate reference.

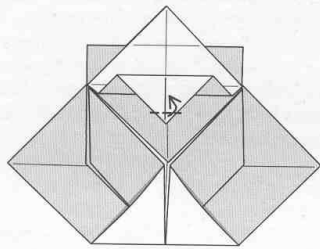

16. Doblar la nariz a gusto.
Valley-fold the nose to taste.

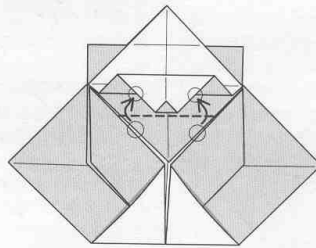

17. Doblar en valle completando los ojos.
Valley-fold completing the eyes.

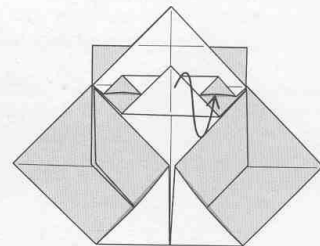

18. Ocultar una punta.
Hide this point.

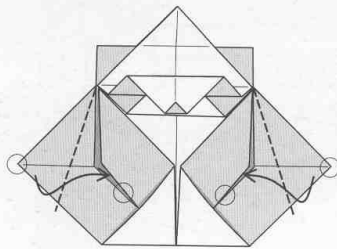

19. Doblar en valle e introducir la aleta en un bolsillo. La punta toca un borde.
Valley-fold the point and tuck it into a pocket. The point touches an edge.

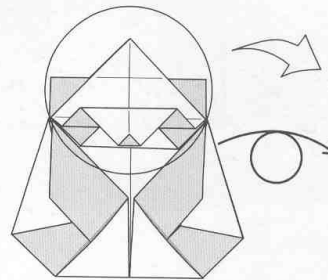

20.

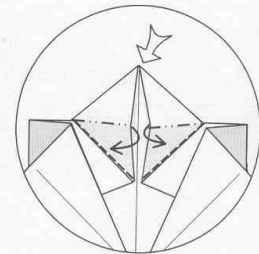

21. Abrir y aplastar.
Squash-fold.

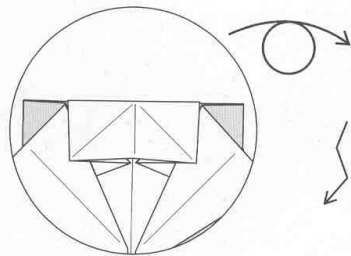

22.

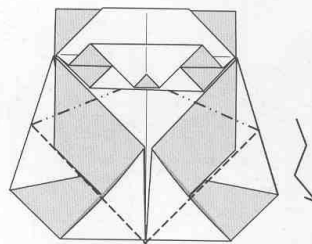

23. Estos ángulos permiten que el panda se pueda sentar.
These angles allow the panda to sit up.

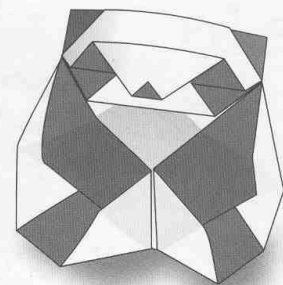

24.

BUHO

OWL

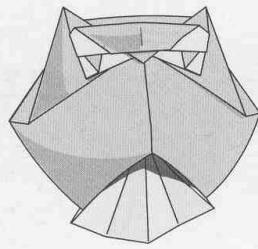

ratio: 0.52

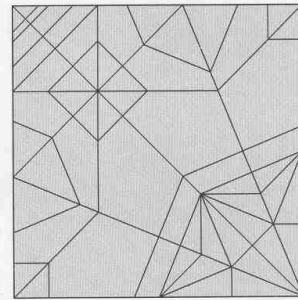
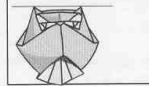

Nivel 2
 Papel favorito: Kami de dos colores.
 Tamaño recomendado: 15 cm.
 Comentarios: doblar en seco.

Level 2
 Favorite paper: Duocolor Kami.
 Recommended size: 15 cm.
 Comments: dry-fold.

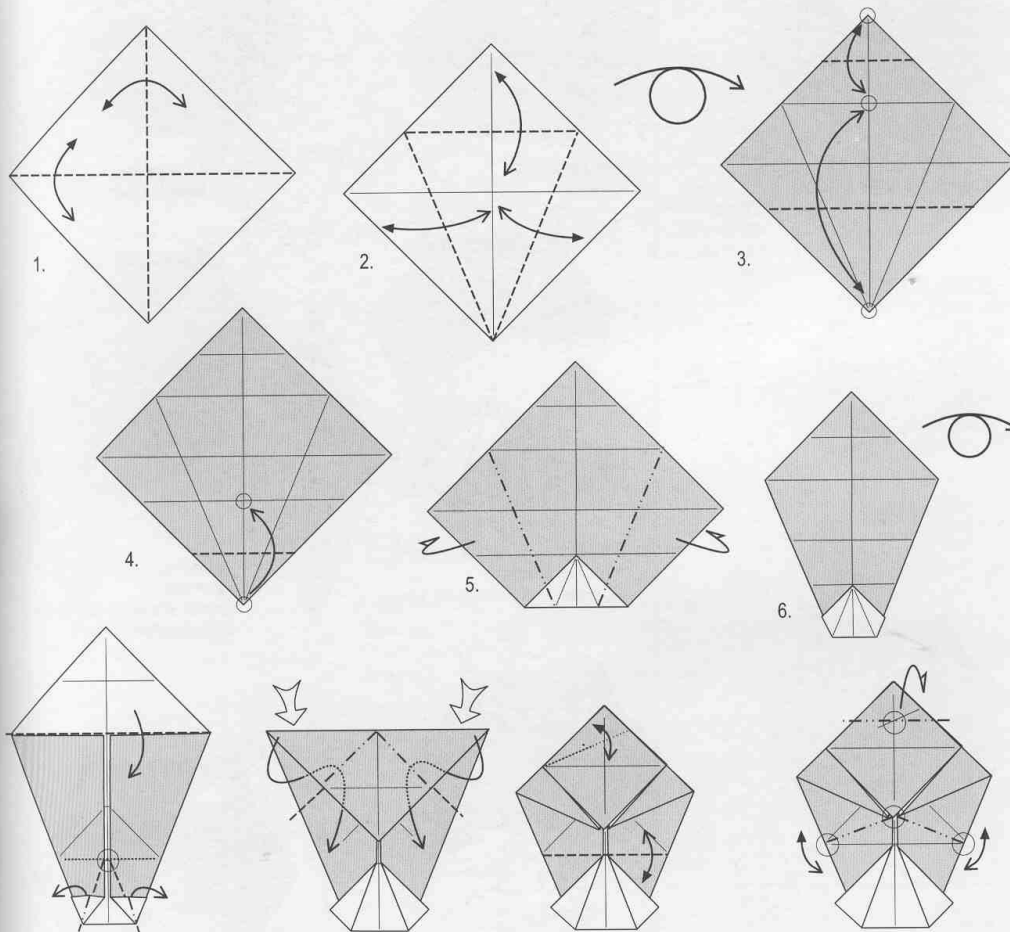

7. Doblar la punta de arriba en valle. Abajo, deslizar las capas hasta la referencia.
Valley-fold the top point. At the bottom, slide the layers to the reference point.

8. Revertir.
Reverse-fold.

9. El doblez de arriba se marca sólo en el centro.
The fold on the top should only be marked at the center.

10. Doblar la punta en monte pasando por la referencia. Marcar dos líneas en monte.
Mountain-fold the top through the reference point. Add two more mountain folds.



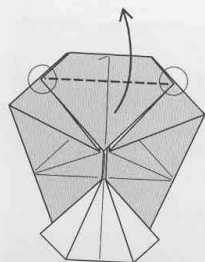

11. Doblar en valle.
Valley-fold.

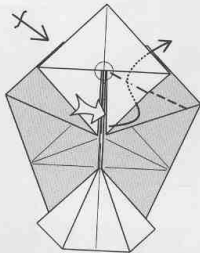

12. Revertir desde la referencia
y tanto como se pueda.
Reverse-fold from the reference
point as far as it will go.

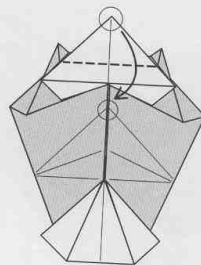

13. Doblar en valle.
Valley-fold.

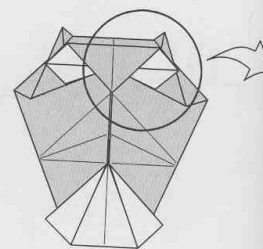

14.

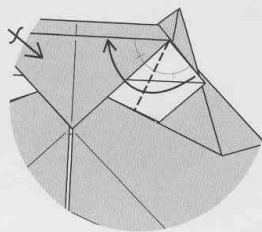

15. Marcar la bisectriz.
Crease the angle bisector.

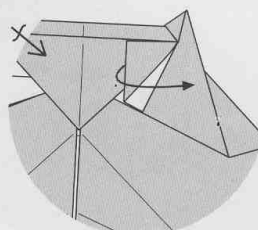

16. Desdoblar.
Unfold.

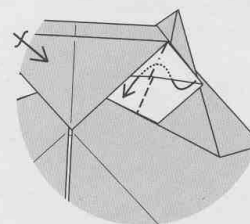

17. Revertir.
Reverse-fold.

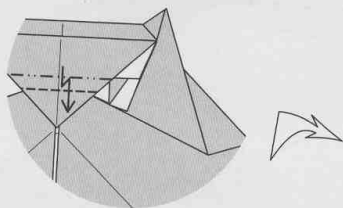

18. Escalonar.
Pleat-fold.

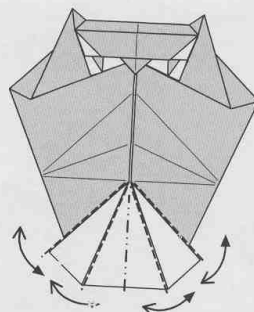

19. Marcar en las direcciones
que se muestran.
Crease in the directions shown.

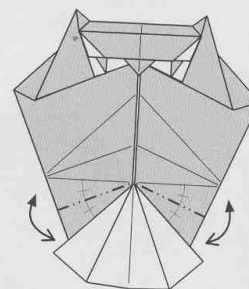

20. Marcar la bisectriz
en monte.
Crease the angle bisectors
with mountain folds.

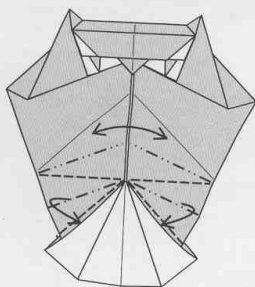

21. Dar curvatura al cuerpo usando estos
dobles. Dos bordes se ocultan dentro
de las capas de la cola y traban el modelo.
Curve the body with these folds. Hide two
edges under the layers of the tail to lock.

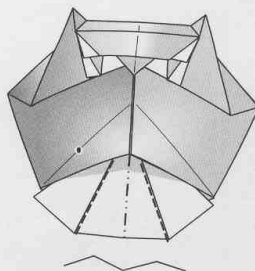

22. Angular las facetas de la cola.
Buscar la mejor posición para que el
bicho se mantenga en pie.
Angle the tail's facets. Try to find the
best position to make the owl stand up.

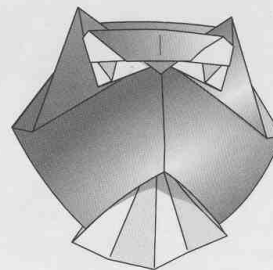

23.

RATONERA

WREN

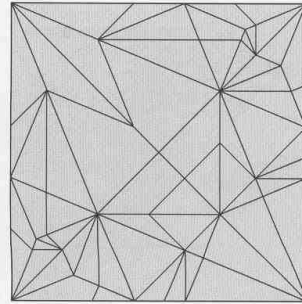
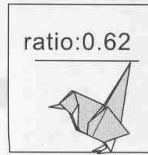
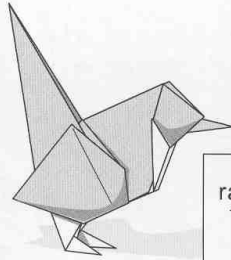

Nivel 2
 Papel favorito: Kami.
 Tamaño recomendado: 15-20 cm.
 Comentarios: doblar en seco.

Level 2
 Favorite paper: Kami.
 Recommended size: 15-20 cm.
 Comments: dry-fold.

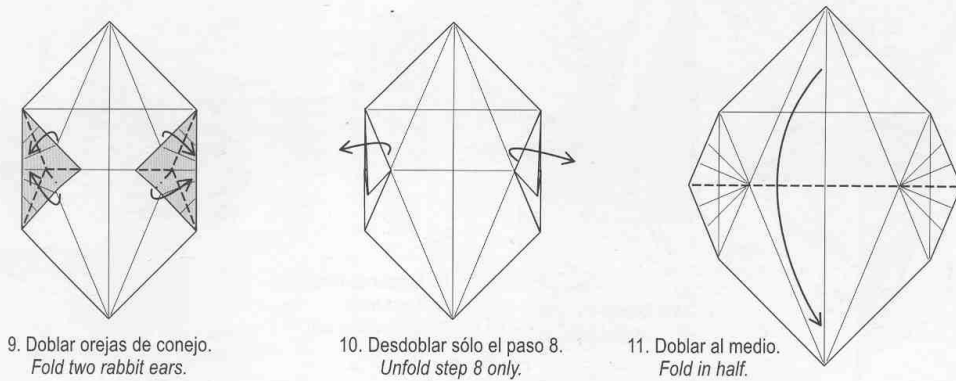
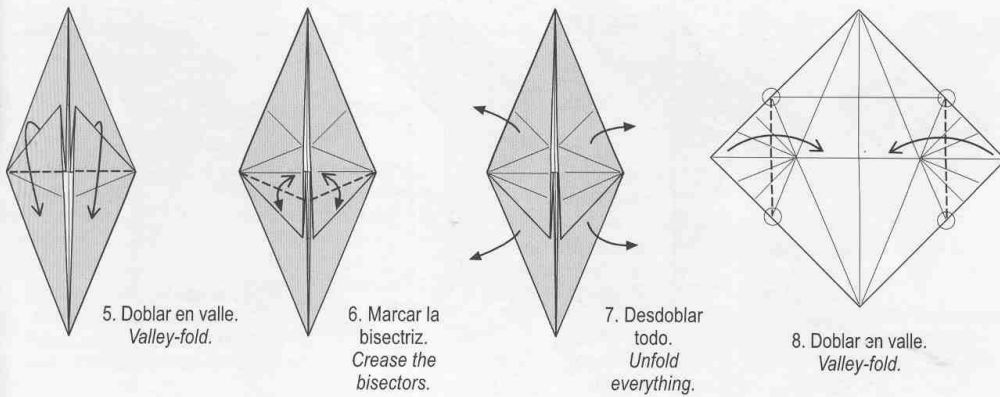
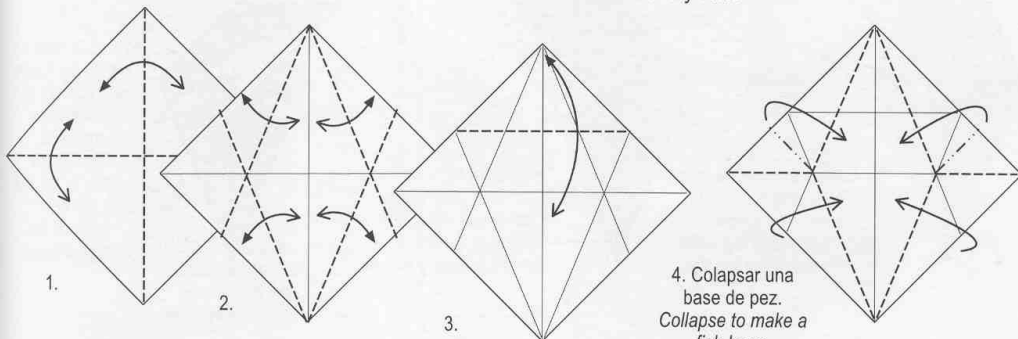

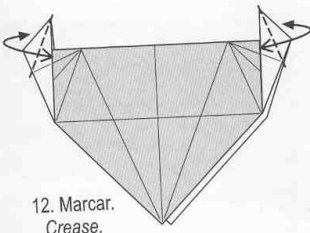

12. Marcar.
Crease.

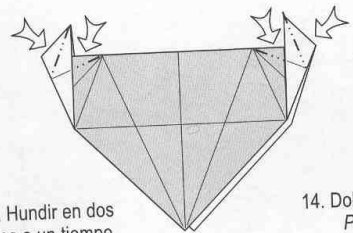

13. Hundir en dos
lados a un tiempo.
Sink in two
directions at the
same time.

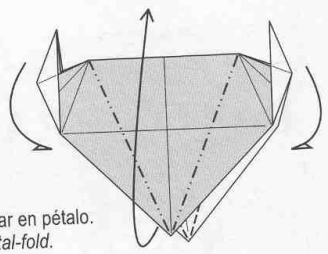

14. Doblar en pétalo.
Petal-fold.

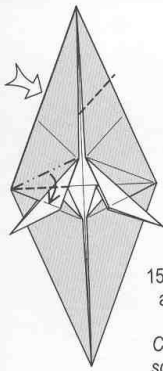

15. Escalonar sobre la pata
al tiempo que se aplasta
la aleta de arriba.
Crimp next to the leg while
squash-folding the top flap.

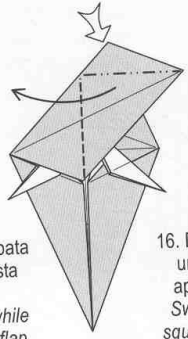

16. Doblar en valle hacia
un lado mientras se
aplasta una esquina.
Swing to the left while
squash-folding a corner.

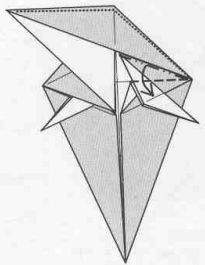

17. Este paso es
similar al 15, pero
esta vez hay que
liberar papel
atrapado.
This step is
similar to 15, but
this time
pull out the
trapped paper.

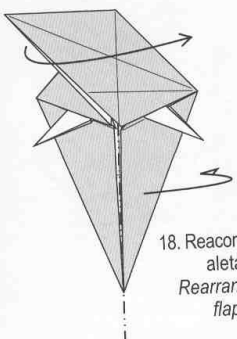

18. Reacomodar las
aletas.
Rearrange the
flaps.

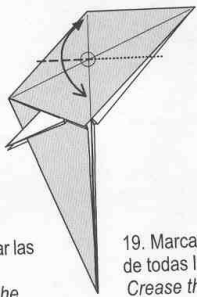

19. Marcar a través
de todas las capas.
Crease through all
layers.

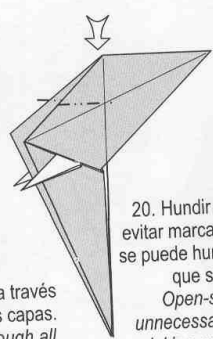

20. Hundir abierto. Para
evitar marcas innecesarias
se puede hundir sólo el lado
que se indica.
Open-sink. Avoid
unnecessary creases by
sinking only in the area
indicated.



21. Ahora sí,
aplanar
ocultando papel.
Now flatten,
hiding some
paper.

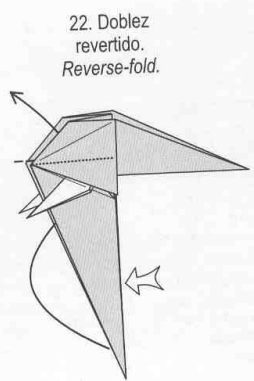

22. Doble
revertido.
Reverse-fold.

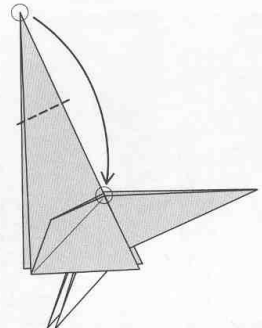

23. Doblar en valle.
Valley-fold.

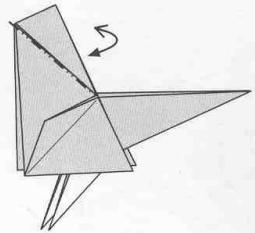

24. Marcar siguiendo
un borde.
Crease along the
edge.

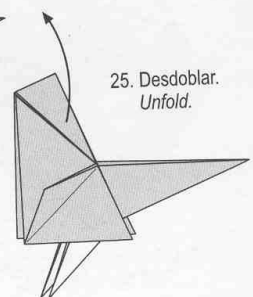

25. Desdoblar.
Unfold.



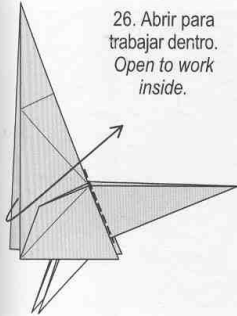

26. Abrir para trabajar dentro.
Open to work inside.

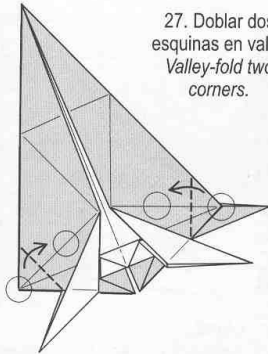

27. Doblar dos esquinas en valle.
Valley-fold two corners.

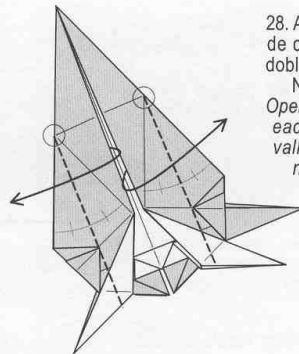

28. Abrir una capa de cada lado con dobleces en valle.
No aplanar
Open one layer on each side using valley-folds. Do not flatten.

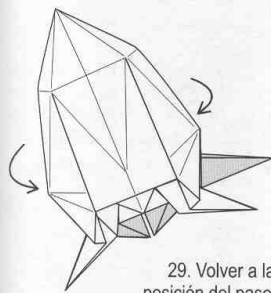

29. Volver a la posición del paso 28.
Go back to the position in step 28.

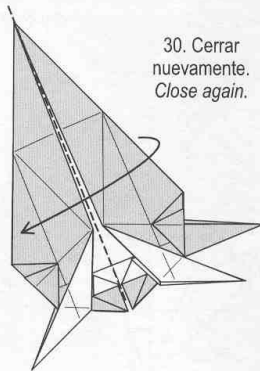

30. Cerrar nuevamente.
Close again.

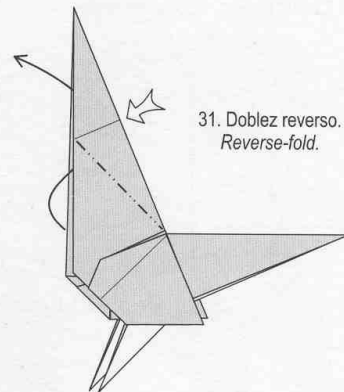

31. Doblez reverso.
Reverse-fold.

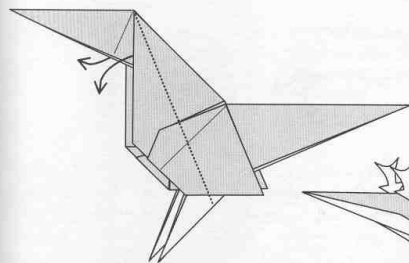

32. Sacar papel del interior usando la marca del paso 28. No aplanar aun.
Pull out paper from the inside using the crease from step 28. Do not flatten yet.



33. Aplanar cambiando el color del pecho.
Flatten changing the color at the breast.

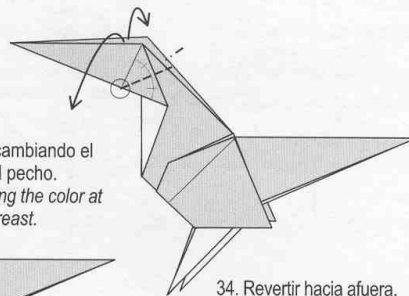

34. Revertir hacia afuera.
Outside reverse-fold.

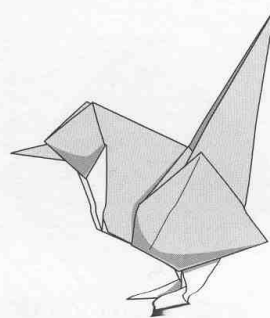
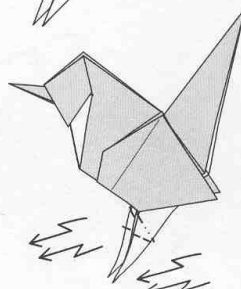
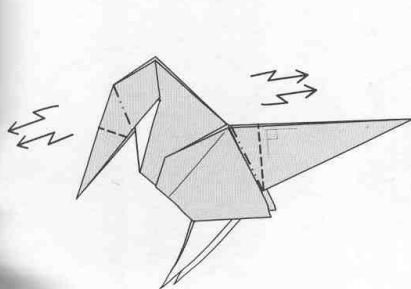

SALMON

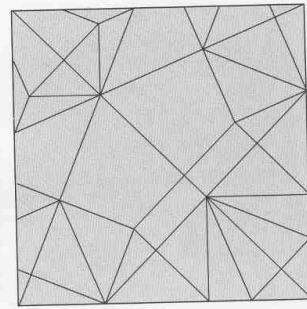
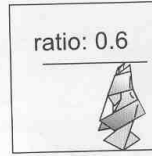
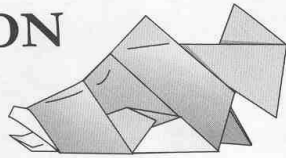

Nivel 2
 Papel favorito: Kami bicolor.
 Tamaño recomendado: 20 cm.
 Comentarios: doblar en seco.

Level 2
 Favorite paper: Duocolor kami.
 Recommended size: 20 cm.
 Comments: dry-fold.

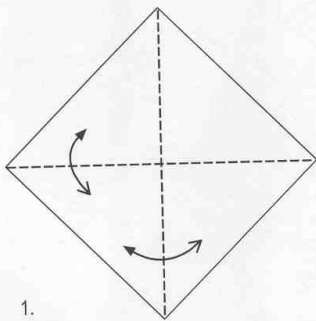

1.

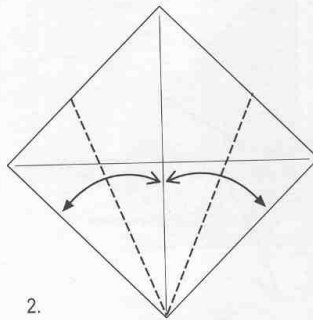

2.

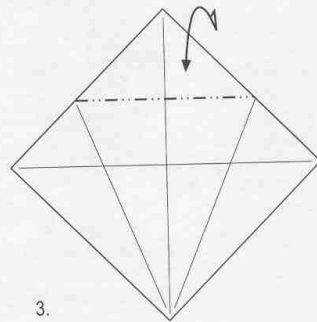

3.

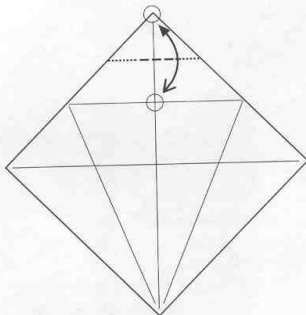

4. Hacer sólo una pequeña marca.
 Just pinch in the center.

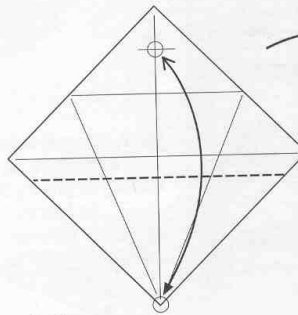

5. Marcar.
 Crease.

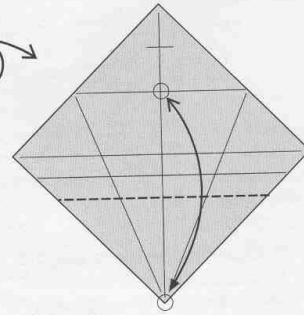

6. Marcar.
 Crease.

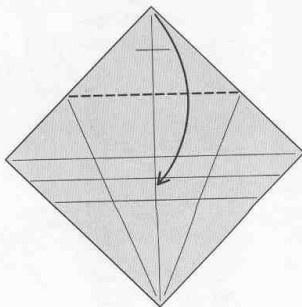

7. Doblar en valle.
 Valley-fold.

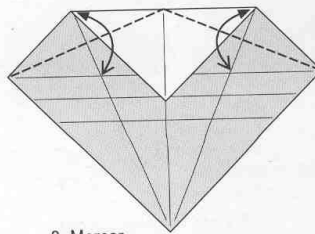

8. Marcar.
 Crease.

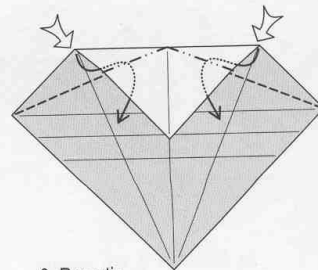

9. Revertir.
 Reverse-fold.



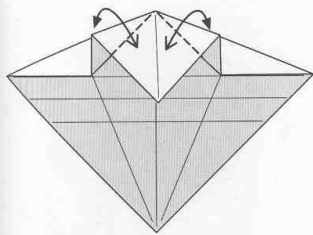

10. Marcar.
Crease.

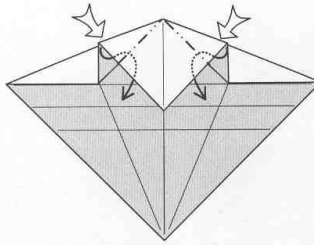

11. Revertir.
Reverse-fold.

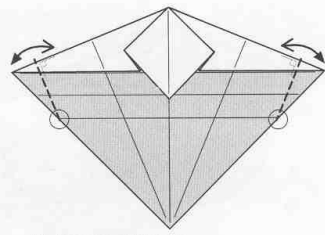

12. Marcar doblando perpendicularmente al borde.
Crease perpendicular to the top edge.

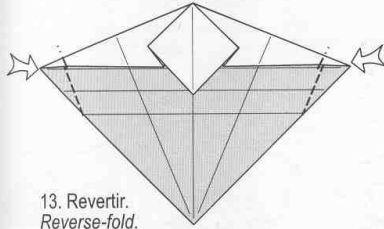

13. Revertir.
Reverse-fold.

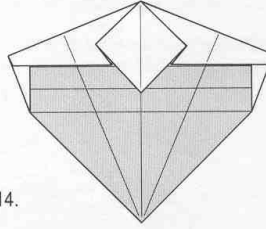

14.

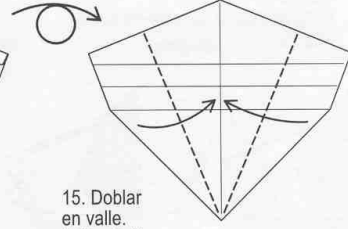

15. Doblar en valle.
Valley-fold.

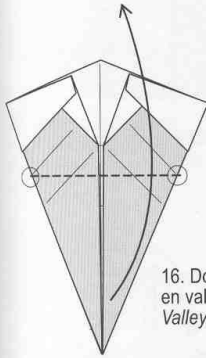

16. Doblar en valle.
Valley-fold.

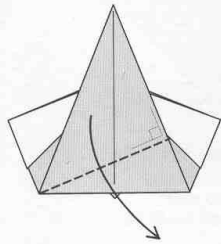

17. Doblar perpendicularmente al borde derecho.
Valley-fold perpendicular to the right edge.

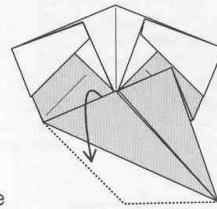

18. Liberar papel atrapado.
Release some trapped paper.

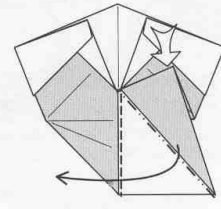

19. Doblar en valle mientras se aplasta una esquina.
Valley-fold while squashing a corner.

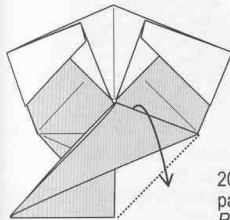

20. Liberar papel atrapado.
Release some trapped paper.

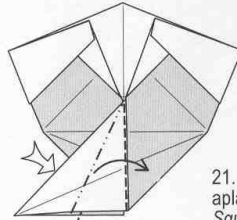

21. Abrir y aplastar.
Squash-fold.

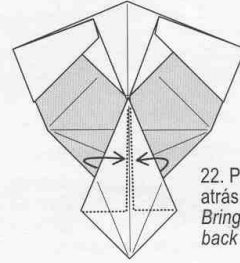

22. Pasar papel de atrás hacia adelante.
Bring paper from the back to the front.

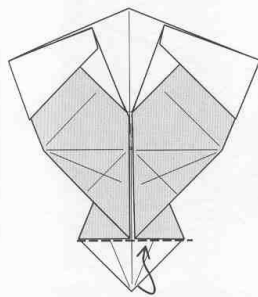

23. Doblar en valle ocultando la punta.
Valley-fold, hiding the tip.

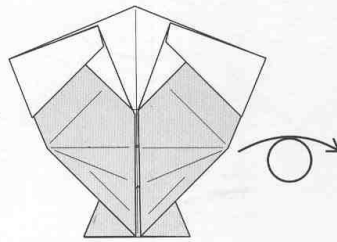

24.

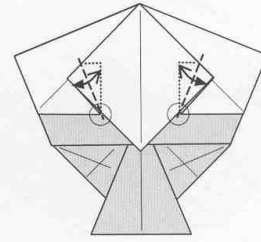

25. Marcar. La única referencia es que el borde termina vertical.
Crease. The only reference is that the edge ends up vertical.



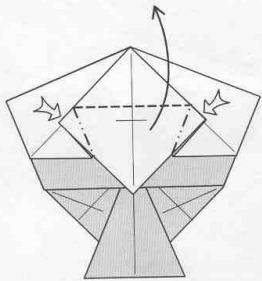

26. Doblar en pétalo siguiendo las marcas de los lados.
Petal-fold using the creases from step 25.

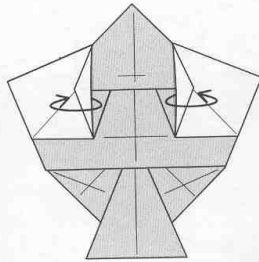

27. Envolver cambiando el color.
Wrap around changing the color.

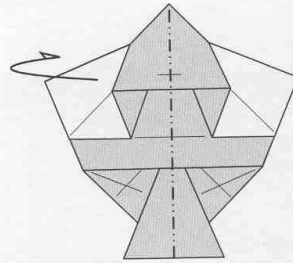

28. Doblar al medio.
Fold in half.

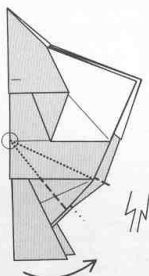

29. Escalonar.
Crimp-fold.

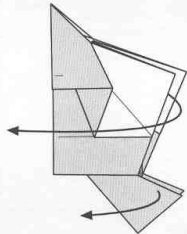

30. Abrir al medio.
Open in half.

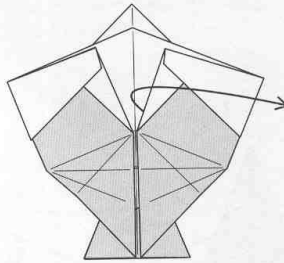

31. Abrir un lado para trabajar debajo. No queda plano. Open one side to work underneath. It will not lie flat.

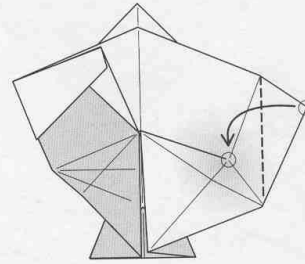

32. Doblar en valle.
Valley-fold.

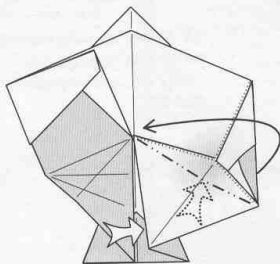

33. Cerrar incorporando un doblez y desdoblado la cola. Close the flap, incorporating a fold and unfolding the tail flap.

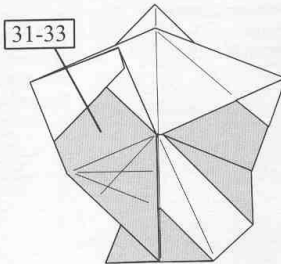

34.

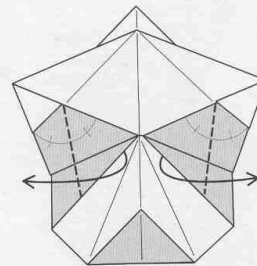

35. Doblar en valle bisectando el ángulo de color. Valley-fold, bisecting the colored angle.

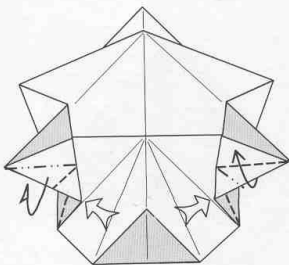

36. En el lado izquierdo se debe meter la aleta en un bolsillo que tiene detrás. On the left side the flap should be tucked into a pocket behind it.

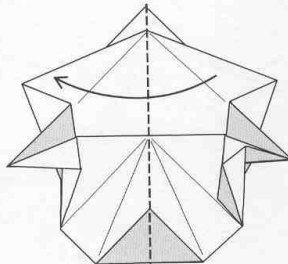

37. Observar cómo los lados han quedado diferentes. Note that the sides are different now.

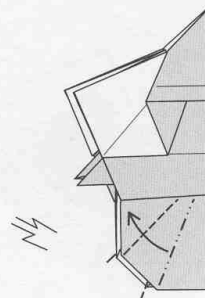

38. Escalonar.
Crimp-fold.

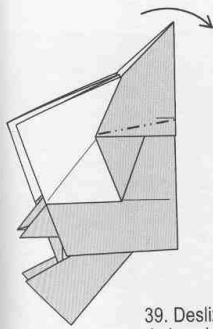

39. Deslizar una capa de la cabeza.
Slide one layer of the head.

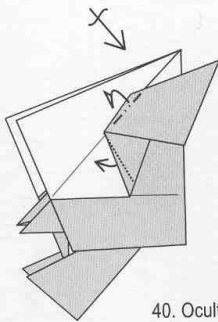

40. Ocultar papel en la cabeza deslizando hacia la aleta.
Hide some of the paper from the head by sliding it to the fin.

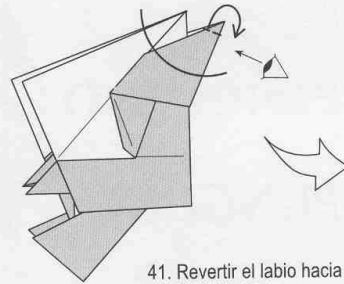

41. Revertir el labio hacia afuera.
Outside reverse-fold the upper lip.

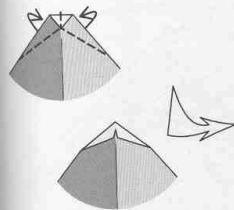

42. Hacer una pequeña oreja de conejo.
Fold a little rabbit ear.

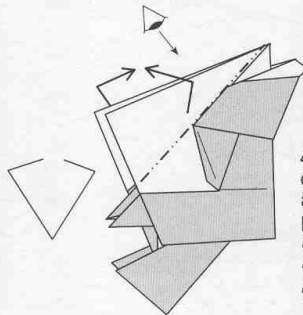

43. Doblar los lados del abdomen en ángulo, preparando para cerrar el cuerpo.
Fold the sides of the belly in at an angle, in preparation for closing the body.

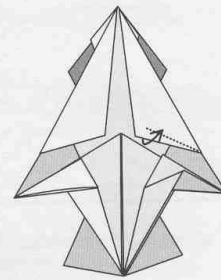

44. Deslizar un poco de papel hacia afuera, sólo lo suficiente para que una mitad del abdomen encaje dentro de la otra.
Slide out a bit of paper; just enough for one half of the belly to fit into the other.

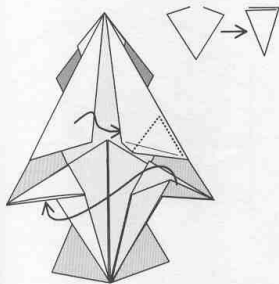

45. Meter una capa dentro de otra y trabar las dos mitades de la aleta.
Tuck one edge into the other and lock the two halves of the fin.

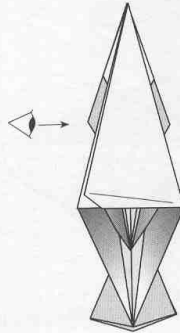

46.

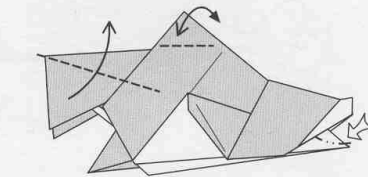

47. Doblar una mitad de la cola en valle. Marcar el límite de la aleta dorsal y dar forma a la boca.
Valley-fold half the tail up. Crease the edge of the dorsal fin and shape the mouth.

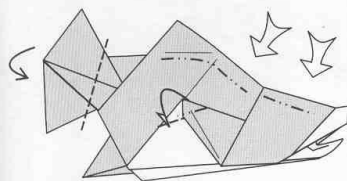

48. Dar forma al cuerpo, revertir en la aleta.
Shape the body, curve the tail and reverse-fold the top of the fins.

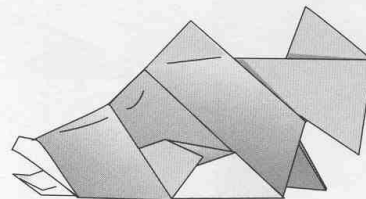

49.



PINGÜINO

PENGUIN

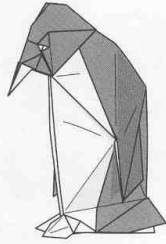

ratio: 0.57

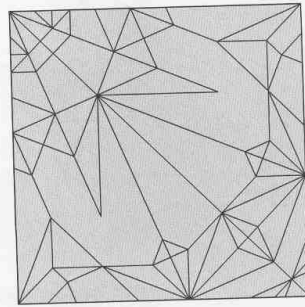

Nivel 3

Papel favorito: papel kami, papel Tant blanco laminado con papel seda negro.
Tamaño recomendado: 20 cm.
Comentarios: doblar en seco.

Level 3

Favorite paper: kami paper, white Tant paper and black tissue paper.
Recommended size: 20 cm.
Comments: dry-fold.

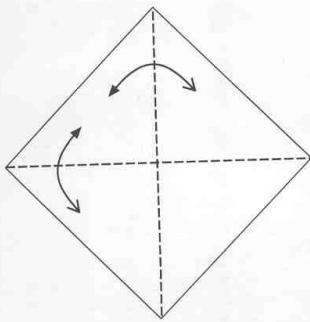

1.

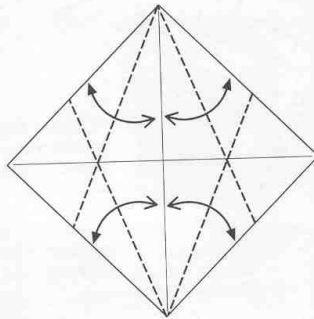

2.

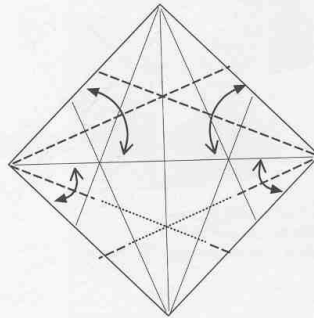

3.

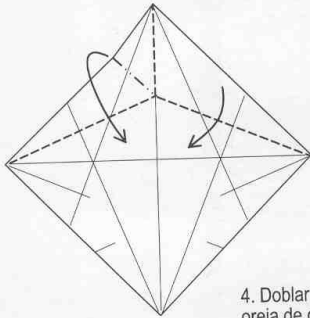

4. Doblar una oreja de conejo.
Fold a rabbit-ear.

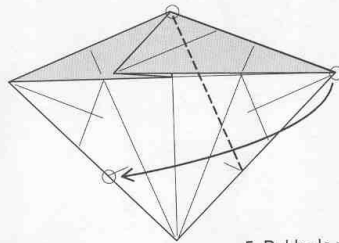

5. Doblar la punta hasta la marca.
Valley-fold a point to the mark.

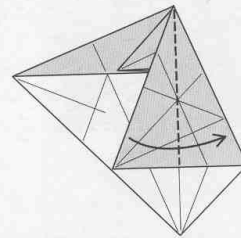

6. Doblar en valle.
Valley-fold.

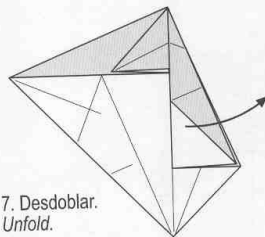

7. Desdoblar.
Unfold.

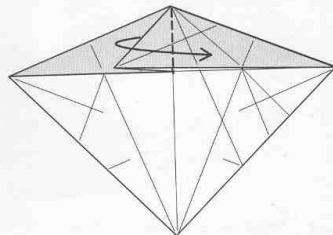

8. Doblar la aleta en valle.
Valley-fold the small flap.

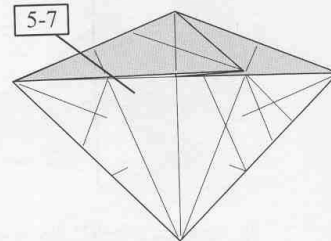

9.



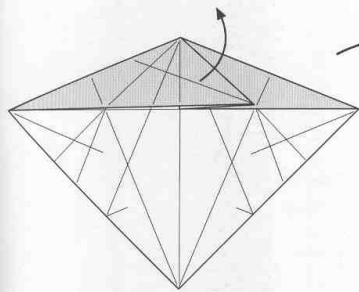

10. Desdoblar todo.
Unfold everything.

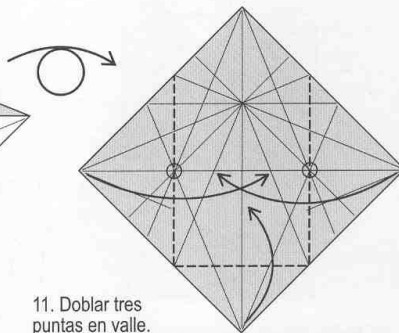

11. Doblar tres
puntas en valle.
Valley-fold three
corners.

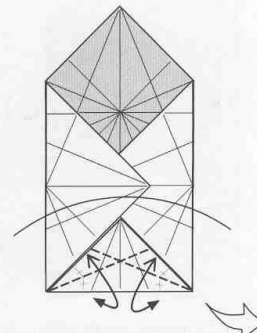

12. Marcar a través de dos capas.
Fold and unfold through two layers.

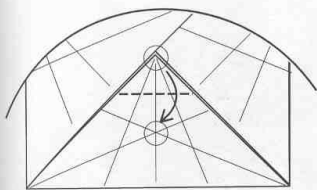

13. Doblar en valle.
Valley-fold.

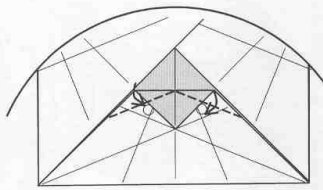

14. Doblar en valle.
Valley-fold.

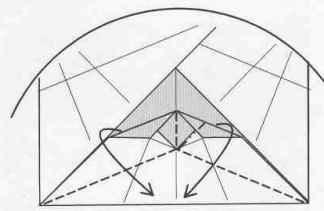

15. Doblar una oreja de conejo.
Fold a rabbit-ear.

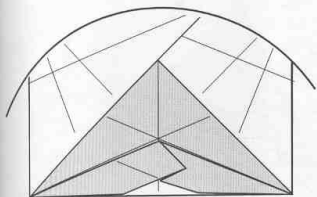

16.

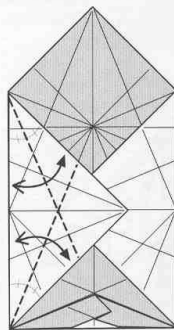

17. Marcar las bisectrices.
Crease the angle bisectors.

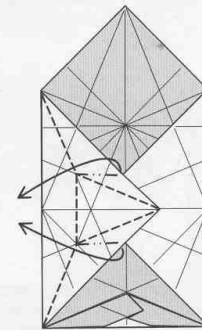

18. Formar una punta.
Make a point.

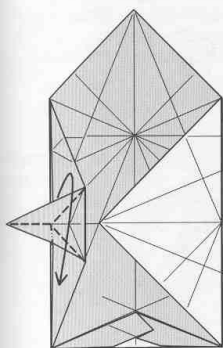

19. Doblar la punta hacia abajo con una
oreja de conejo.
Fold the point downwards with a
rabbit ear.

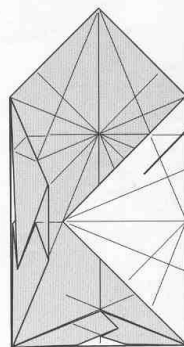

20.

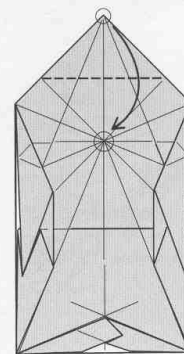

21. Doblar la punta hasta la marca.
Valley-fold a point to the mark.



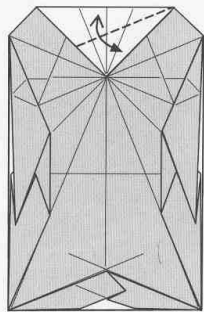

22. Marcar.
Crease.

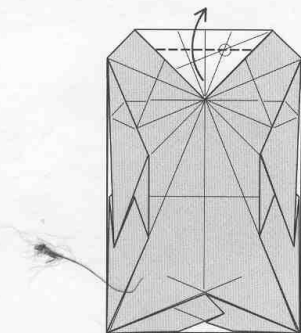

23. Doblar en valle pasando por la intersección.
Valley-fold through the intersection.

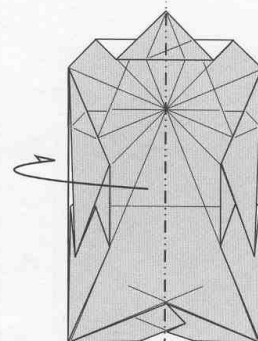

24. Doblar al medio.
Fold in half.

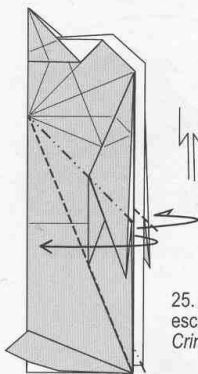

25. Doblez escalonado.
Crimp-fold.

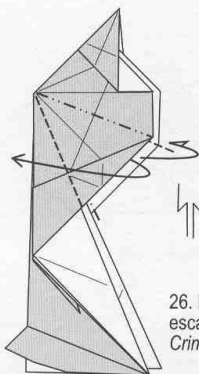

26. Doblez escalonado.
Crimp-fold.

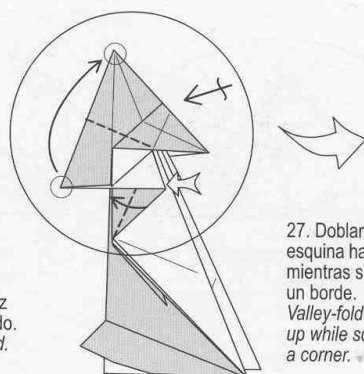

27. Doblar una esquina hacia arriba mientras se aplasta un borde.
Valley-fold the point up while squashing a corner.

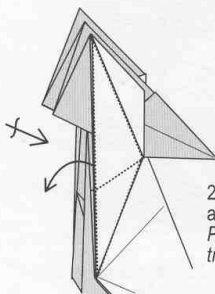

28. Liberar papel atrapado.
Pull out the trapped paper.

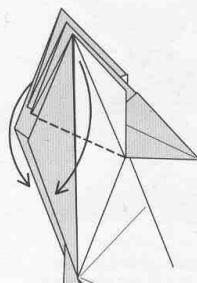

29. Doblar dos puntas.
Valley-fold two points down.

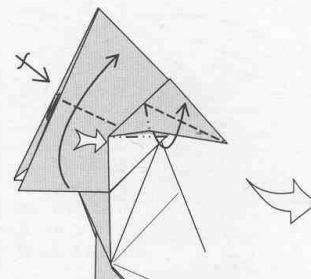

30. Levantar las puntas de nuevo incorporando más dobleces.
Fold two points up again, incorporating some more folds.

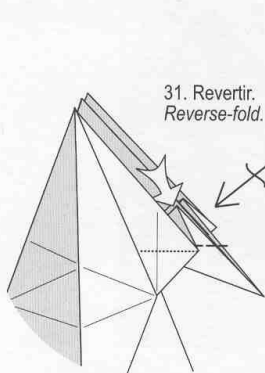

31. Revertir.
Reverse-fold.

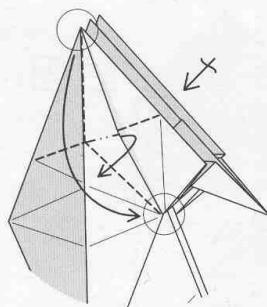

32. Doblar en valle incorporando un doblez revertido.
Valley-fold the tips down, incorporating a reverse fold.

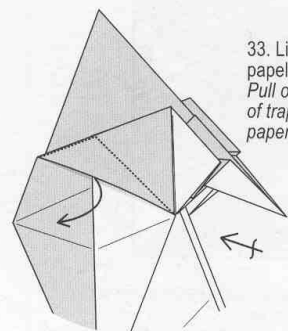

33. Liberar papel atrapado.
Pull out a layer of trapped paper.



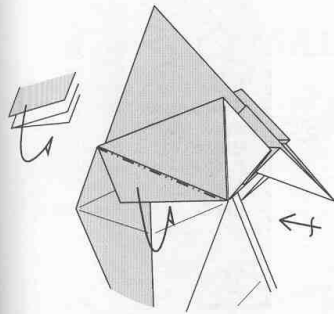

34. Meter la aleta detrás de dos bordes blancos.
Tuck the flap behind two white edges.

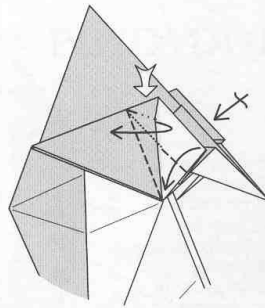

35. Abrir y aplastar alineando bordes.
Squash-fold, aligning two edges.

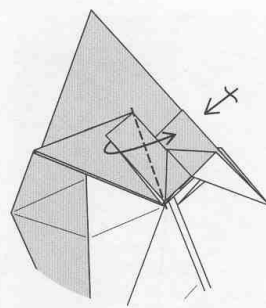

36. Doblar dos capas en valle.
Valley-fold two layers.

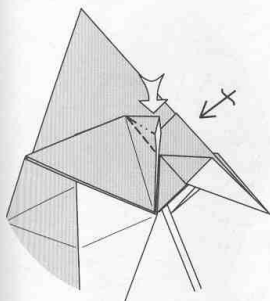

37. Abrir y aplastar.
Squash-fold.

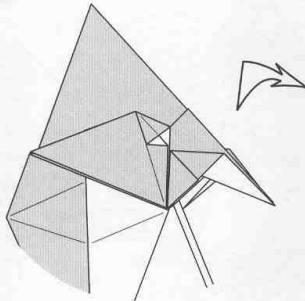

38.

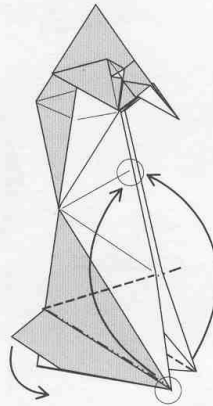

39. Escalonar las patas rotando el conjunto de la cola.
Crimp-fold the legs, rotating the tail down.

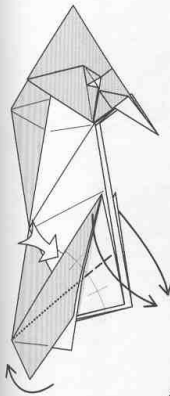

40. Abrir y aplastar los dos lados al mismo tiempo.
Squash-fold both sides at the same time.

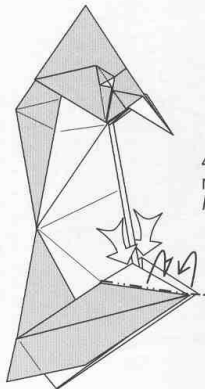

41. Doblez revertido.
Reverse-fold.

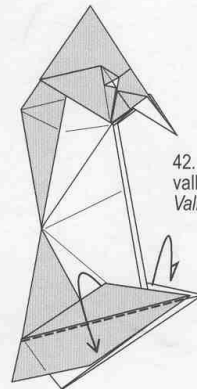

42. Doblar en valle.
Valley-fold.

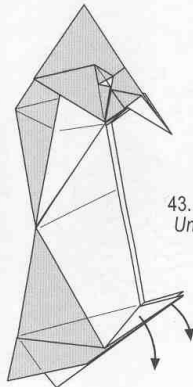

43. Desdoblar hasta el paso 39.
Unfold to step 39.

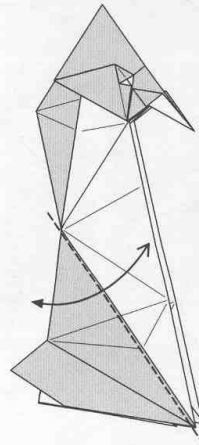

44. Marcar a través de todas las capas.
Crease through all layers.



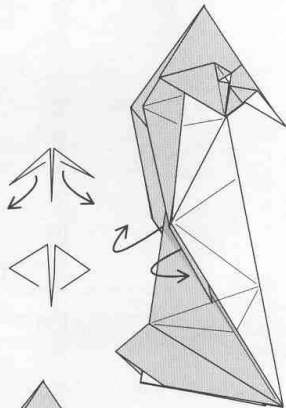

45. Abrir dos bordes internos dando volumen.
Open up two internal borders making the model 3-dimensional.

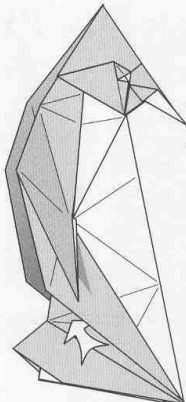

46. Empujar la capa central de manera que quede apoyada contra una de las paredes laterales.
Push on the central layer so that it leans against one of the sides within the model.
See the cross-section below.

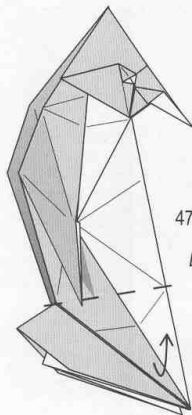

47. Levantar un poco la aleta.
Lift the flap a bit.

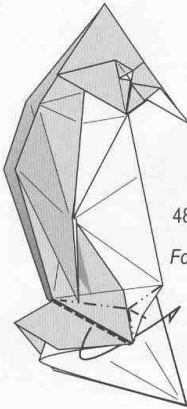

48. Doblar una oreja de conejo simple.
Fold a simple rabbit-ear.

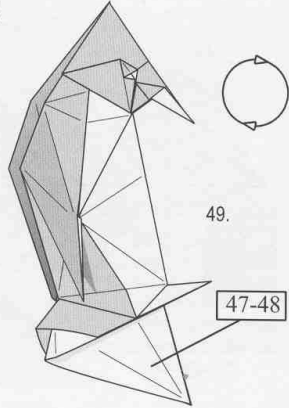

49.

47-48

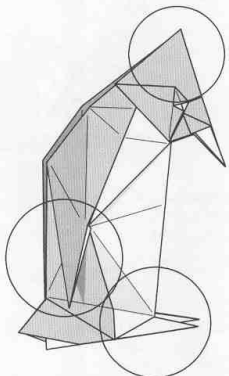

50. Hacer terminaciones para las patas, alas y cabeza.
Give the finishing touches to the feet, flippers and head.

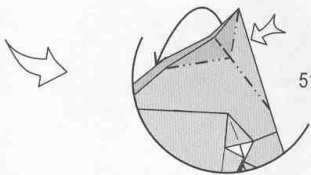

51.

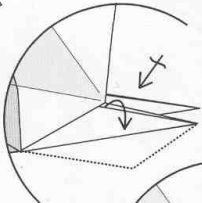

52.

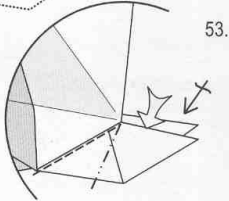

53.

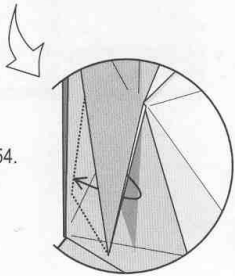

54.

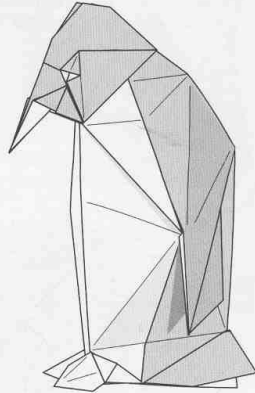

55.



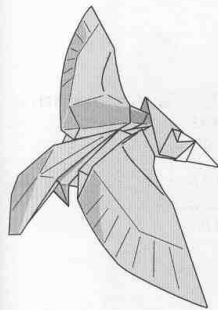

MARTIN PESCADOR

KINGFISHER

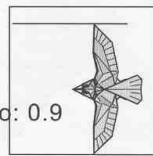

ratio: 0.9

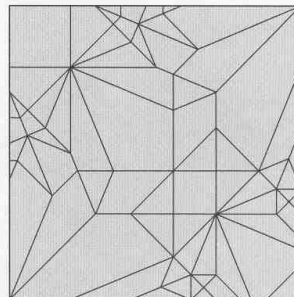

Nivel 3
 Papel favorito: Tant pintado en una cara.
 Tamaño recomendado: 20 cm.
 Comentarios: Plegar en seco o apenas humedecido.

Level 3
 Favorite paper: Tant, painted on one side.
 Recommended size: 20 cm.
 Comments: Fold dry, or with lightly dampened paper.

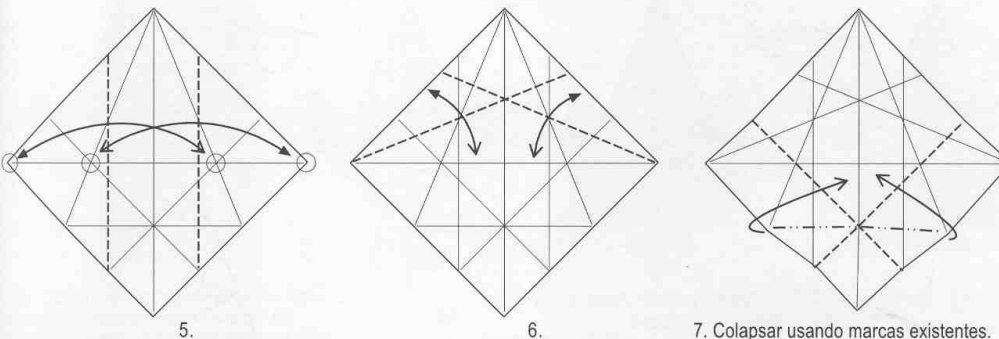
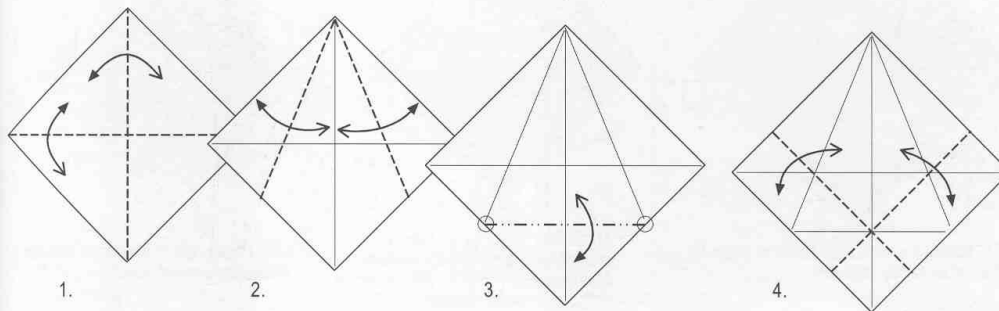

7. Colapsar usando marcas existentes.
 Collapse on existing creases.

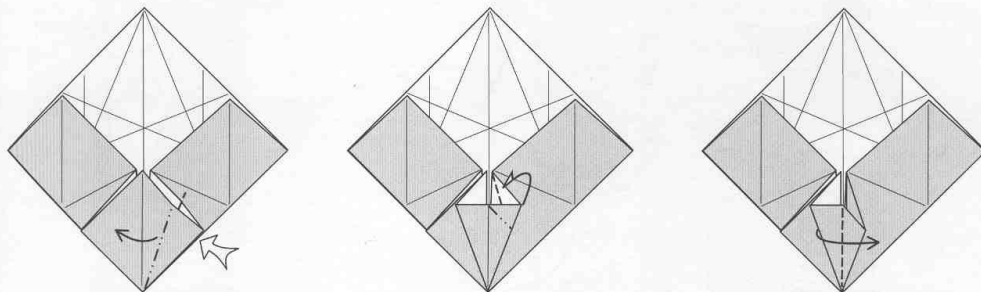

8. Abrir y aplastar.
 Squash-fold.

9. Doblez revertido.
 Reverse-fold.

10. Doblar en valle.
 Valley-fold.



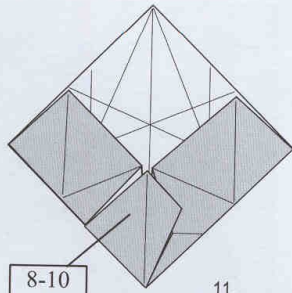

11.

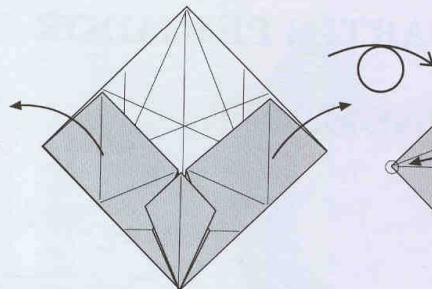

12. Desdoblar totalmente y dar vuelta.
Unfold completely and turn over.

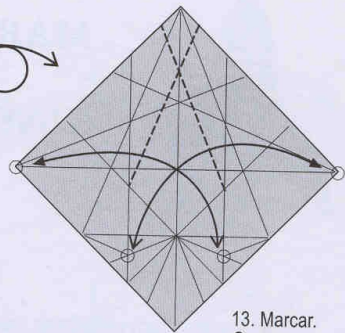

13. Marcar.
Crease.

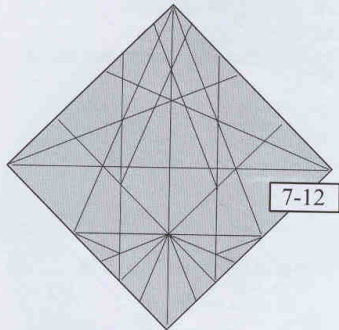

14. Volver a doblar todo hasta el paso 12.
Refold as far as step 12.

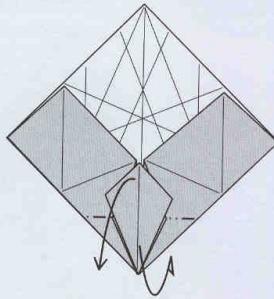

15. Doblar la punta en monte
pivotando una aleta hacia adelante.
Mountain-fold the point behind, while
a flap pivots downwards.

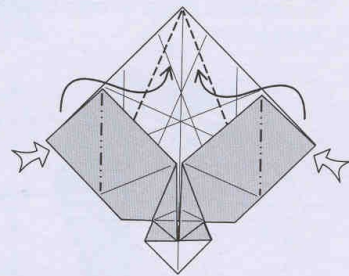

16. Hacer dos dobleces revertidos.
Make two reverse folds.

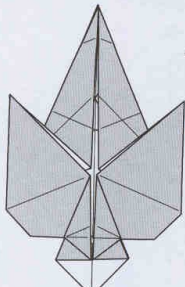

17.

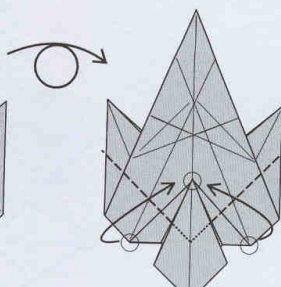

18. Doblar en valle. Parte ocurre
debajo de otra capa.
Valley-fold. This is partially covered
by another layer.

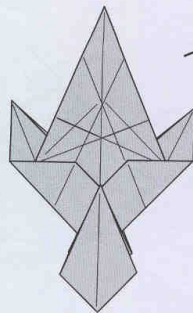

19.

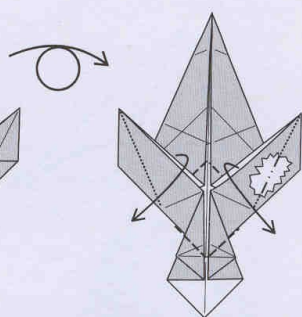

20. Abrir la primera capa tanto como se
pueda al tiempo que se aplasta la capa
de abajo.
Valley-fold the top layer down as far as
possible, while squashing the layer
below.

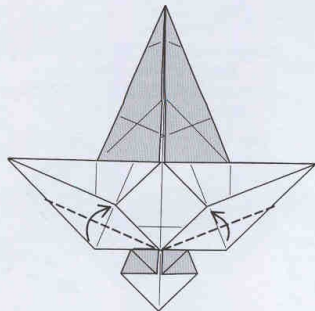

21. Doblar en valle.
Valley-fold.

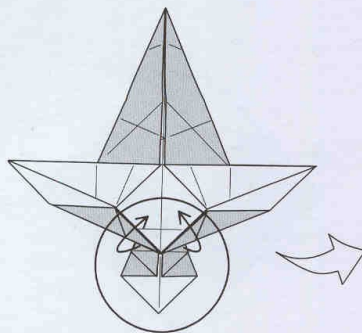

22. Liberar papel atrapado.
Release some trapped paper.

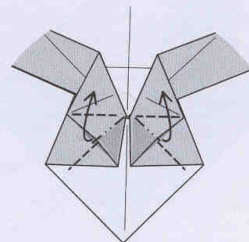

23. Abrir y aplastar dos aletitas.
Squash-fold two little flaps.



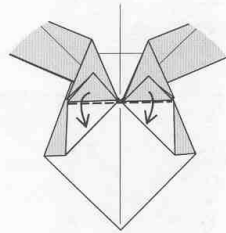

24. Doblar en valle.
Valley-fold.

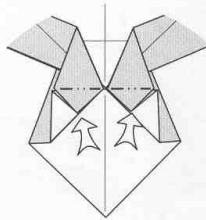

25. Revertir.
Reverse-fold.

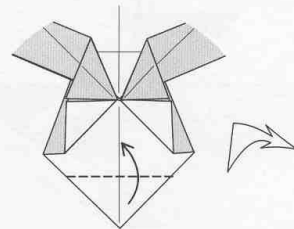

26. Doblar en valle sin referencia.
Valley-fold, there is no reference.

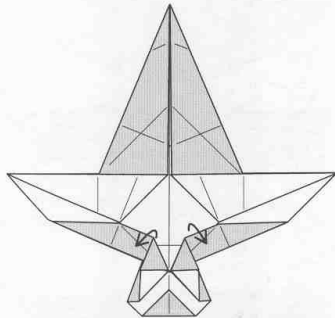

27. Pasar un borde hacia adelante.
Bring an edge to the front.

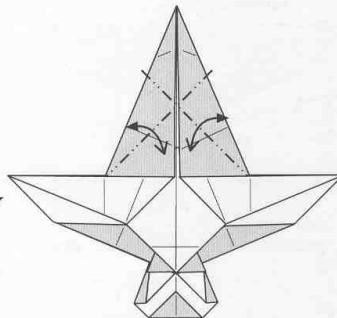

28. Marcar en todas las capas siguiendo una marca existente.
Crease through all layers following an existing mark.

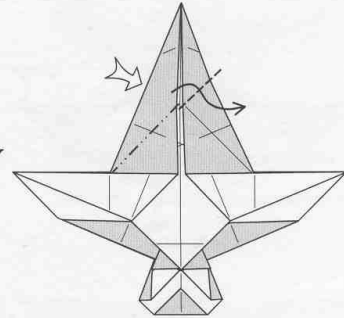

29. Revertir.
Reverse-fold.

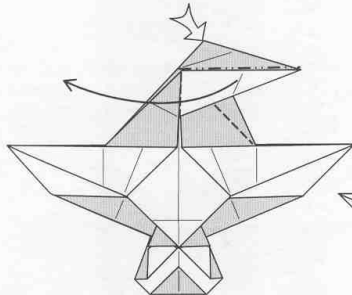

30. Doblar la punta hacia la izquierda mientras se aplasta una esquina.
Swing the point to the left while squashing a corner.

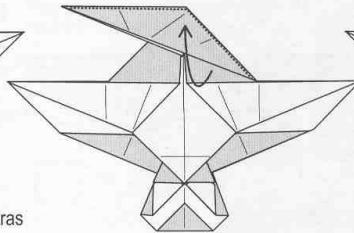

31. Liberar papel atrapado.
Release some trapped paper.

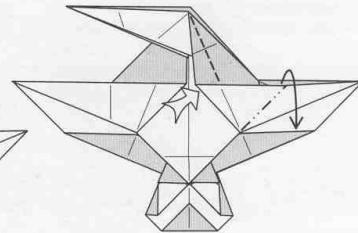

32. Pivotar.
Swivel-fold.

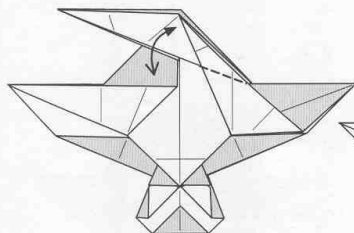

33. Doblar y desdoblar.
Fold and unfold.

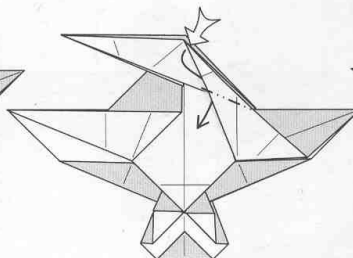

34. Revertir.
Reverse-fold.

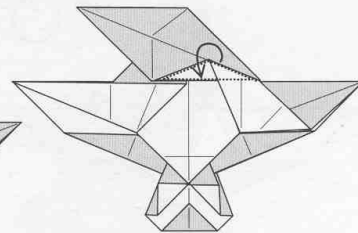

35. Envolver una capa cambiando el color.
Wrap one layer around.



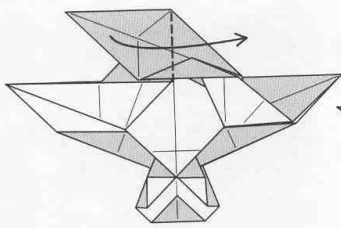

36. Doblar en valle.
Valley-fold.

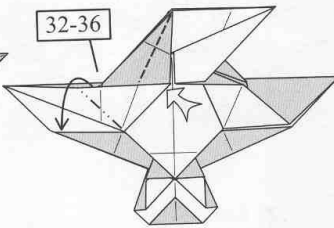

37. Repetir los pasos 32-36.
Repeat steps 32-36.

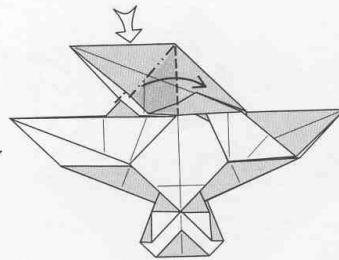

38. Abrir y aplastar.
Squash-fold.

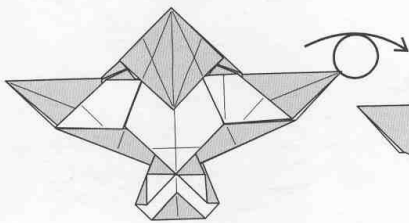

39.

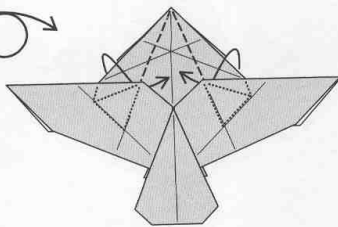

40. Revertir un borde tanto
como se pueda.
Reverse-fold an edge as
far as possible.

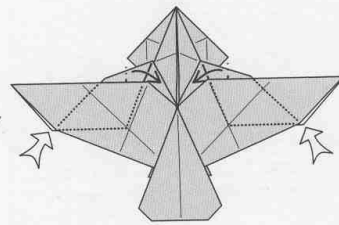

41. Pivotar el borde restante
bajo el ala.
Swivel-fold the remaining edge
under the wing.

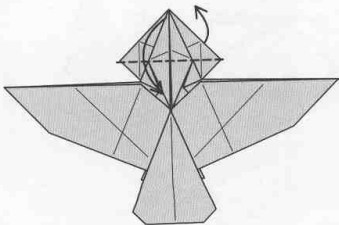

42. Doblar en valle rotando la capa de abajo.
Valley-fold, flipping up the point underneath.

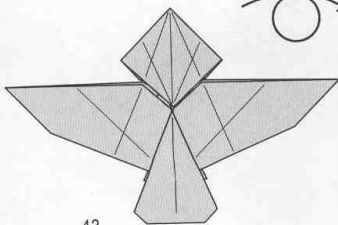

43.

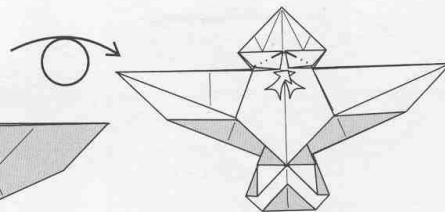

44. Abrir y aplastar. Ver la posición
final en el siguiente dibujo.
Squash-fold. See the final position
in the next drawing.

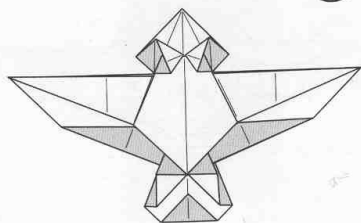

45.

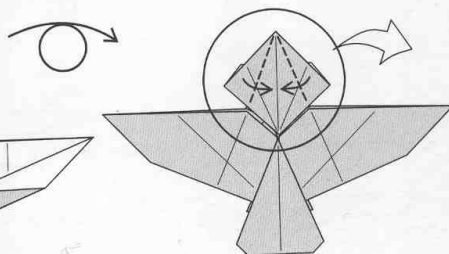

46. Doblar en valle.
Valley-fold.

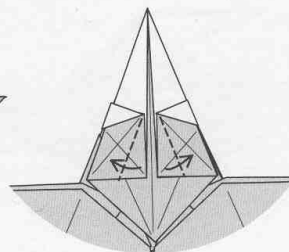

47. Doblar en valle.
Valley-fold.



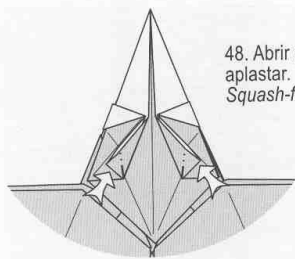

48. Abrir y aplastar.
Squash-fold.

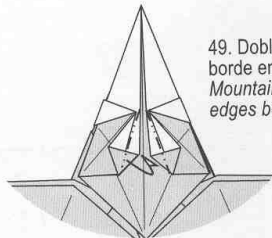

49. Doblar un borde en monte.
Mountain-fold the edges behind.

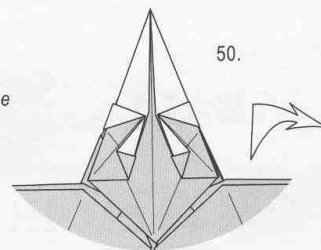

50.

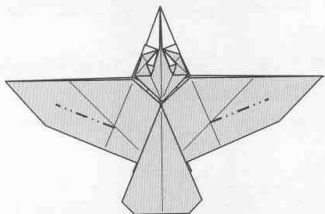

51. Marcar firmemente en monte siguiendo un borde oculto.
Mountain-crease firmly following a hidden edge.

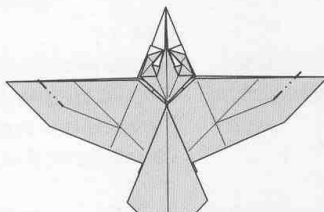

52. Continuar la marca. Notar cómo imita el borde del ala.
Continue the crease as shown. Note how it parallels the edge of the wing.

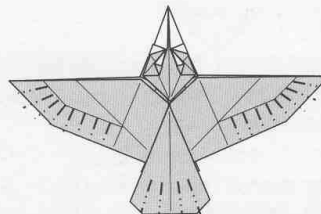

53. Firme y cuidadosamente marcar estas plumas en monte.
Carefully and firmly, mountain-crease these feathers.

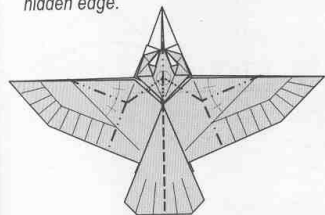

54. Esta vez los dobleces deben formar facetas bien definidas en la superficie.
This time the folds should angle the surface into facets.

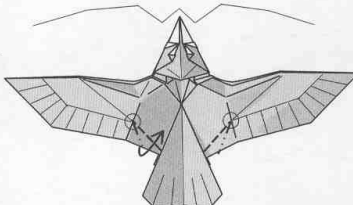

55. Pivotar. El doblez en valle ya existe, el monte es nuevo.
Swivel-fold. The valley fold exists, the mountain fold is fresh.

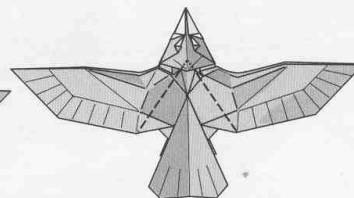

56. Las puntas de las alas van a haber bajado. Traerlas hacia arriba con este doblez en valle.
The wings will have bent down. Bring them up with this valley fold.

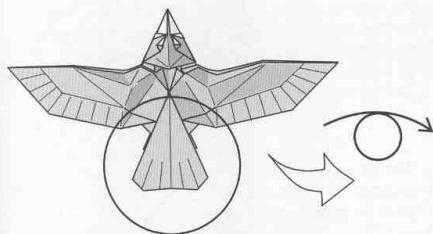

57. Detalle de la cola y las patas del otro lado.
Close up of the tail and legs on the other side.

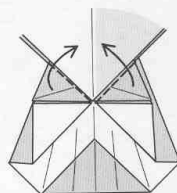

58-59. Subir las patas. Dar forma a la cola.
Fold the legs up. Shape the tail.

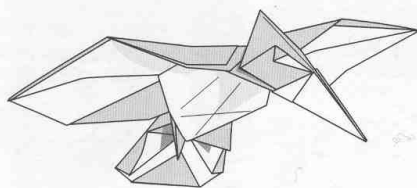
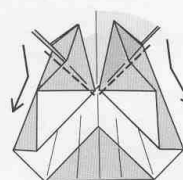

60.

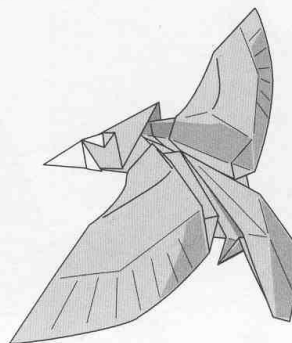

JABALI

WILD BOAR

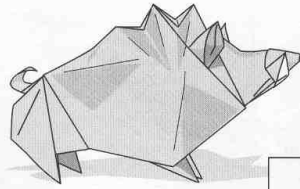

ratio: 0.33

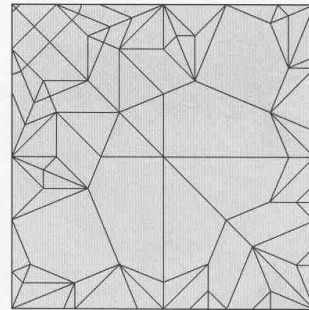

Nivel 3

Papel favorito: Tant pintado de blanco en una cara.
En todo caso debe ser un papel bicolor, firme y no demasiado delgado.

Tamaño recomendado: 22 cm.

Comentarios: doblar en seco.

Level 3

Favorite paper: Tant paper, painted white on one side or any fairly stiff duocolor paper that is not too thin.

Recommended size: 22 cm.

Comments: dry-fold.

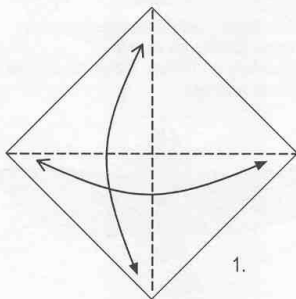

1.

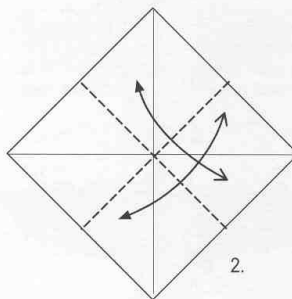

2.

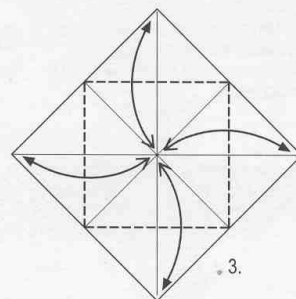

3.

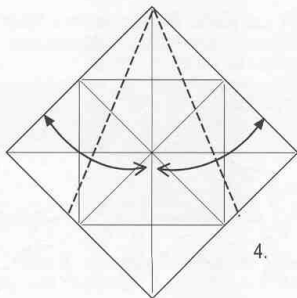

4.

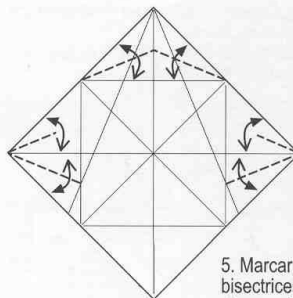

5. Marcar seis bisectrices.
Crease six angle bisectors.

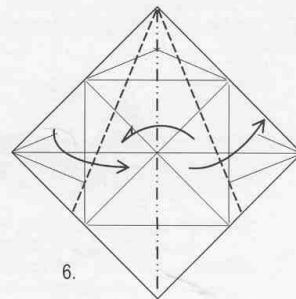

6.

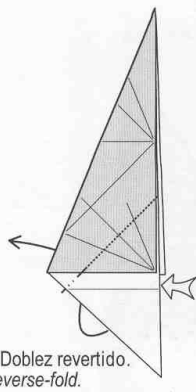

7. Doblez revertido.
Reverse-fold.

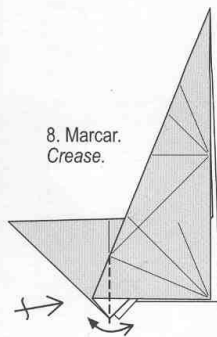

8. Marcar.
Crease.

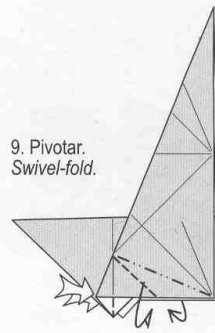

9. Pivotar.
Swivel-fold.

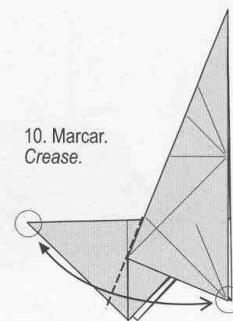

10. Marcar.
Crease.



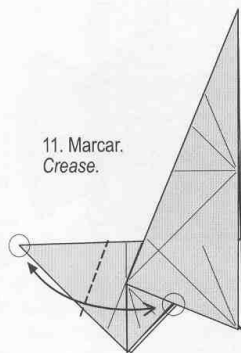

11. Marcar.
Crease.

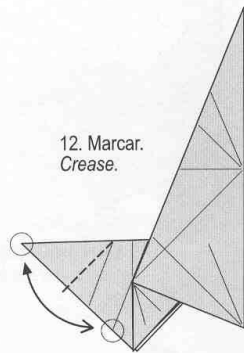

12. Marcar.
Crease.

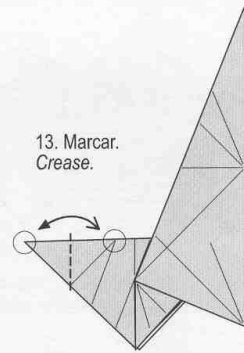

13. Marcar.
Crease.



14. Abrir y
aplastar.
Squash-fold.

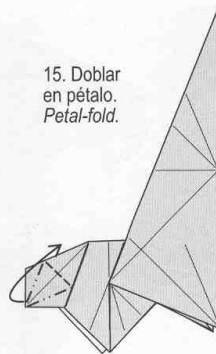

15. Doblar
en pétalo.
Petal-fold.

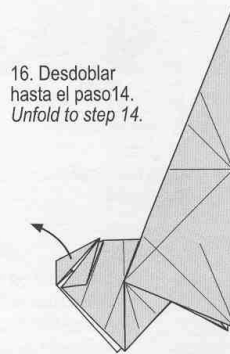

16. Desdoblar
hasta el paso 14.
Unfold to step 14.

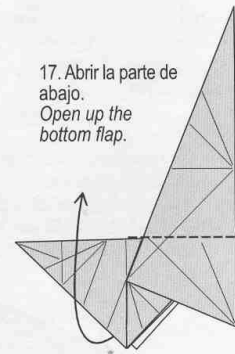

17. Abrir la parte de
abajo.
Open up the
bottom flap.

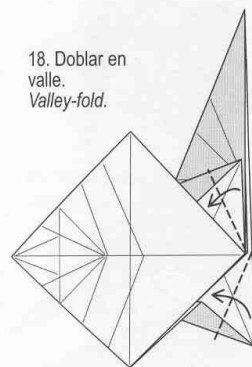

18. Doblar en
valle.
Valley-fold.

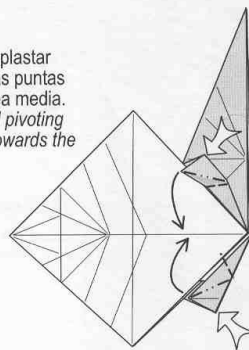

19. Abrir y aplastar
pivotando las puntas
hasta la línea media.
Squash-fold pivoting
the points towards the
center line.

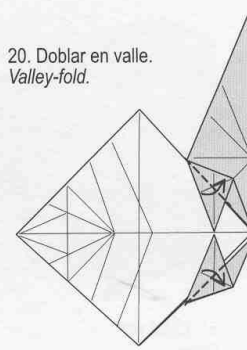

20. Doblar en valle.
Valley-fold.

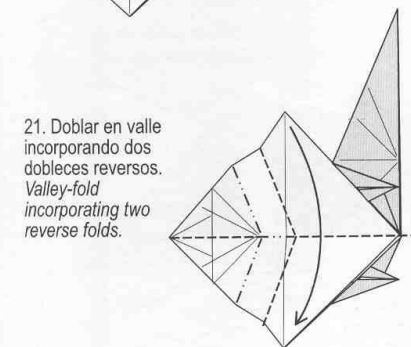

21. Doblar en valle
incorporando dos
dobles reversos.
Valley-fold
incorporating two
reverse folds.

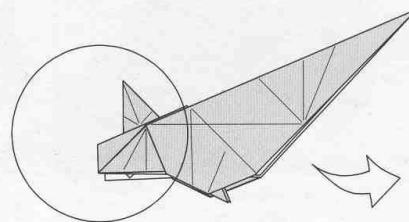

22



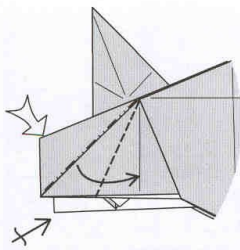

23. Abrir y aplastar.
Squash-fold.

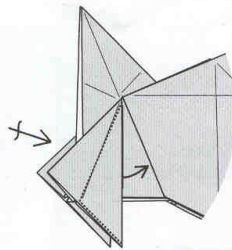

24. Sacar papel atrapado.
Release some trapped paper.

25. Meter la aleta en un bolsillo.
Tuck the flap in a pocket.

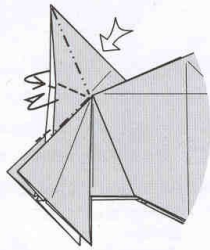
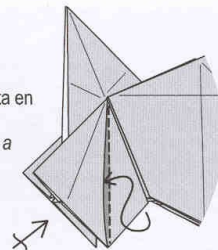

26. Hacer una doble oreja de conejo sobre los dobleces del paso 15.
Fold a double rabbit ear using the creases from step 15.

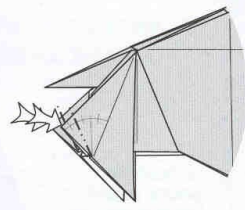

27. Revertir dos esquinas.
Make two small reverse folds.

28. Doblar la aleta en valle.
Valley-fold the flap.

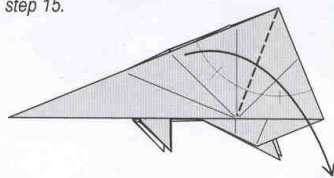
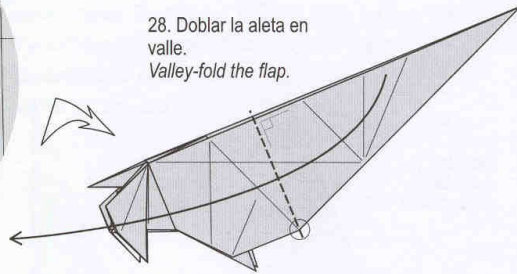

29. Doblar en valle bisectando el ángulo.
Valley-fold through the corner's bisector.

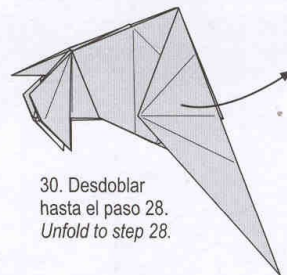

30. Desdoblar hasta el paso 28.
Unfold to step 28.

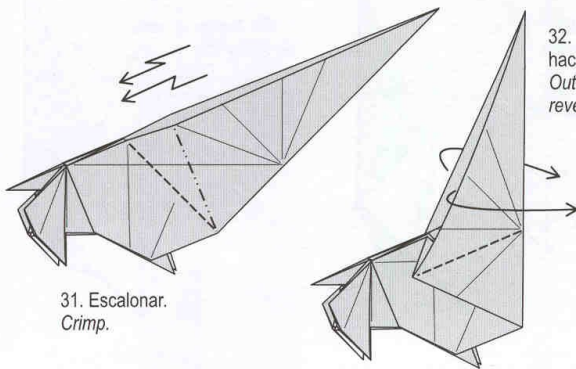

31. Escalonar.
Crimp.

32. Revertir hacia afuera.
Outside reverse-fold.

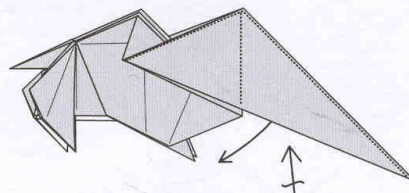

33. Liberar papel atrapado.
Pull out trapped paper.

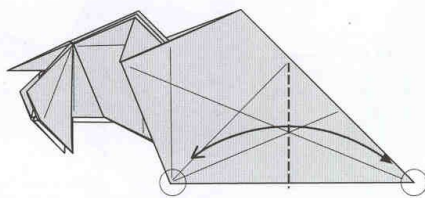

34. Doblar y desdoblar.
Fold and unfold.

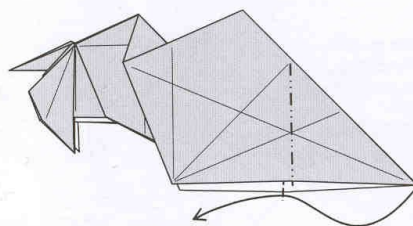

35. Revertir.
Reverse-fold.



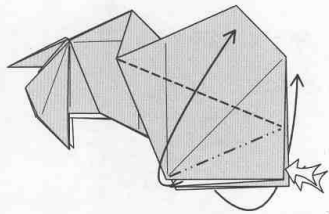

36. Doblar una aleta en valle de cada lado mientras se aplastan las esquinas.
Valley-fold a flap on each side while squashing the corners.

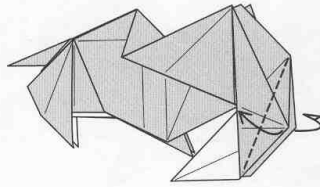

37. Doblar en valle.
Valley-fold.

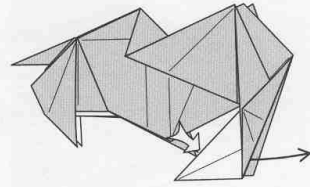

38. Revertir el borde blanco tanto como se pueda.
Reverse-fold the white edge as far as it will go.

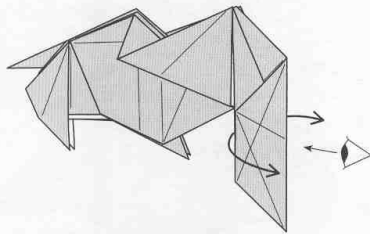

39. Abrir la capas y mirar de frente.
Spread and look from the front.

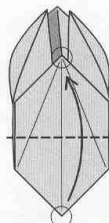

40. Doblar en valle.
Valley-fold.

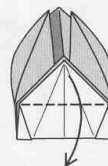

41. Doblar en valle.
Valley-fold.

42. Cerrar nuevamente.
Close the front of the model again.

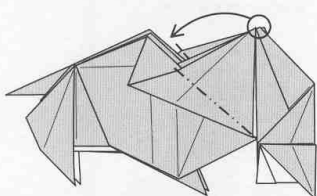
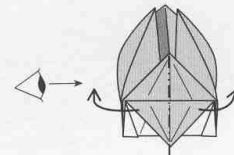

43. Tomar juntas las tres puntas de arriba y rotar el conjunto tanto como se pueda.
Take the three points and swing the group down as far as it will go.

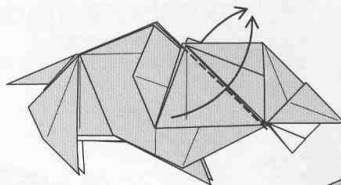

44. Doblar en valle todas las capas de cada lado.
Valley-fold all layers on each side.

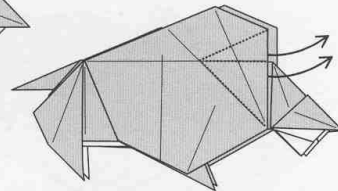

45. Sacar dos bordes atrapados.
Release two trapped edges.

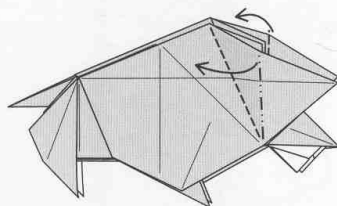

46. Escalonar en ambos lados.
Pleat both sides.

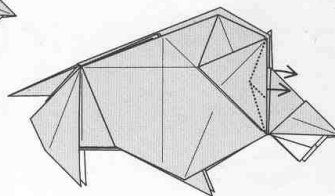

47. Sacar un borde hacia afuera de cada lado.
Pull out a flap on each side.

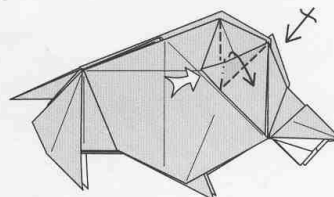

48. Pivotar.
Swivel-fold.



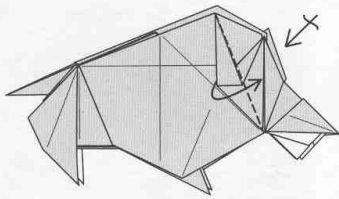

49. Doblar el borde en valle de ambos lados.
Valley-fold this edge on both sides.

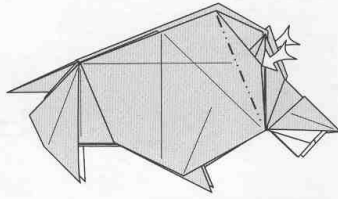

50. Hundir cerrado de ambos lados.
Closed-sink on both sides.

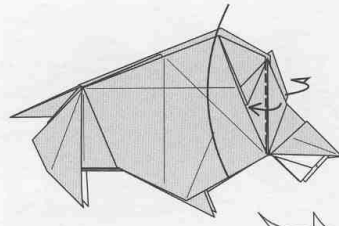

51. Doblar un borde en valle completando las orejas.
Valley-fold an edge to complete the ears.

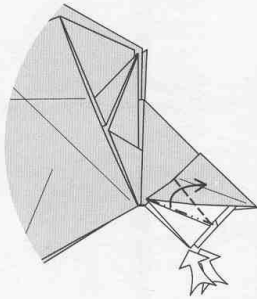

52. Pivotar los colmillos hacia arriba.
Swivel-fold the tusks up.

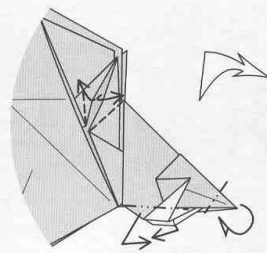

53. Ocultar la punta del hocico, abrir las orejas.
Hide the tip of the snout, open up the ears.

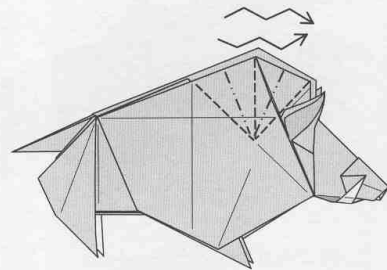

54. Marcar estos dobleces como se muestra para dar la impresión de pelos en el lomo.
Pleat the back to give the impression of the bristles on the back.

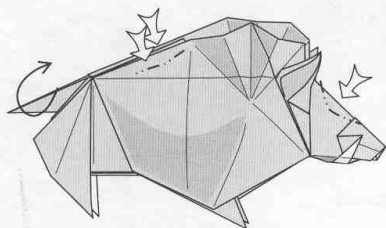

55. Ultimos toques.
A few last touches.

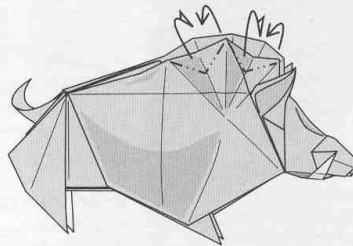

56.

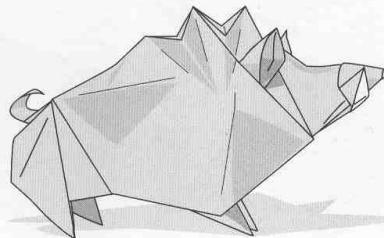

57.



ELEFANTITO EQUILIBRISTA

ACROBATIC ELEPHANT

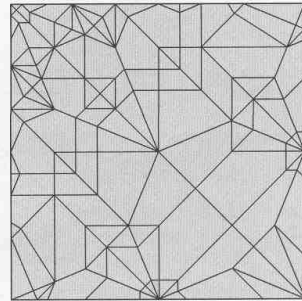
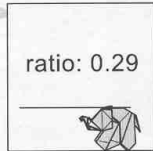
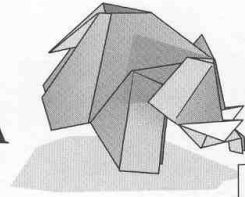

Nivel 3
Papel favorito: Kami bicolor.
Tamaño recomendado: 20 cm.
Comentarios: doblar en seco.

Level 3
Favorite paper: Duocolor kami
Recommended size: 20 cm.
Comments: dry-fold.

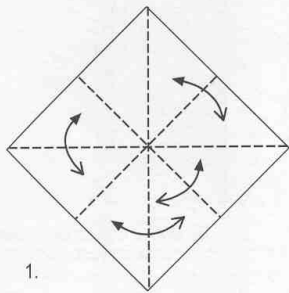

1.

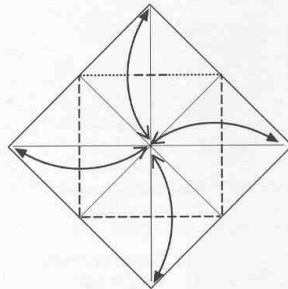

2. Notar que la marca de la esquina superior se hace sólo en el medio.
Note that the top crease is only a pinch.

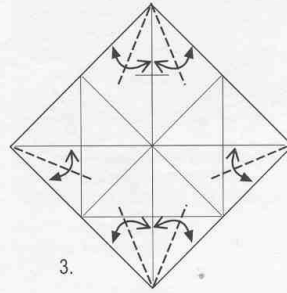

3.

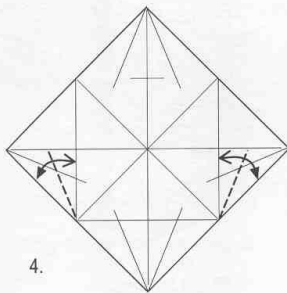

4.

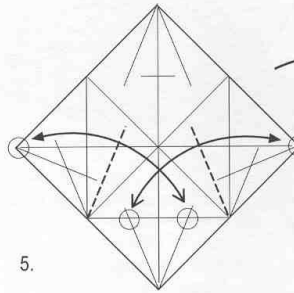

5.

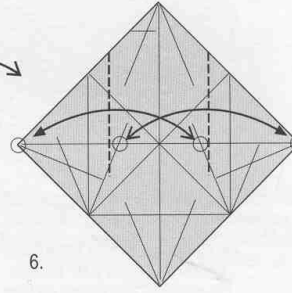

6.

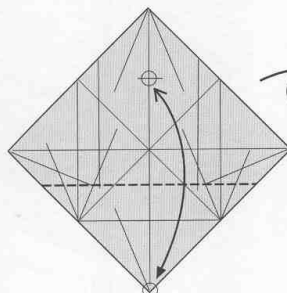

7. La referencia es la marca del paso 2.
The reference point is the pinch from step 2.

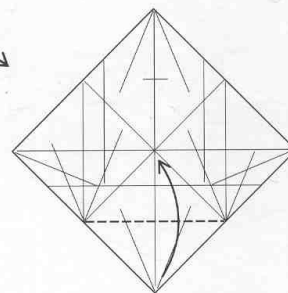

8. Doblar en valle.
Valley-fold.

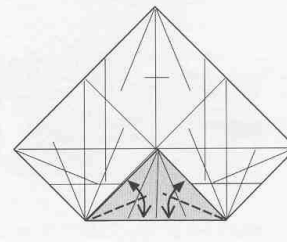

9. Marcar.
Crease.



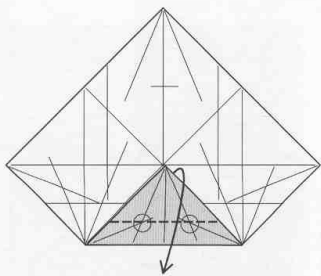

10. Doblar en valle pasando por las intersecciones.
Valley-fold through the intersections.

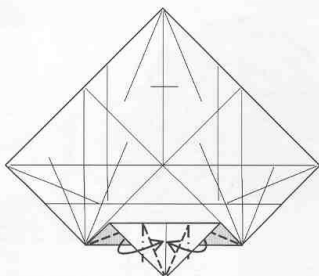

11. Formar una punta.
Make a point with swivel-folds.

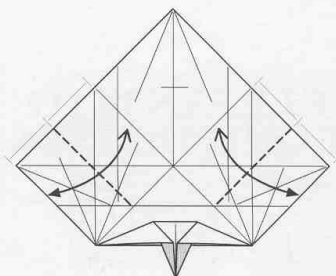

12. Marcar.
Crease.

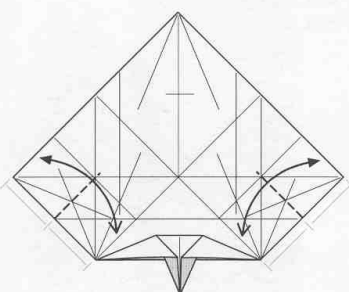

13. Marcar.
Crease.

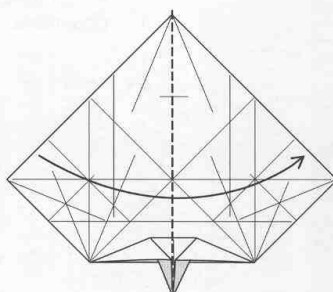

14. Doblar al medio.
Fold in half.

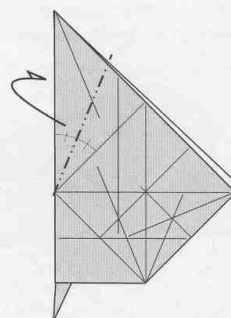

15. Doblar dos capas juntas.
Fold two layers as one.

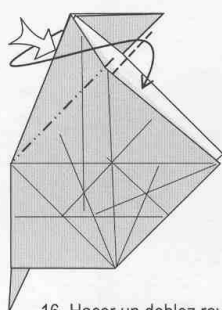

16. Hacer un doblez revertido en todas las capas a un tiempo.
Reverse-fold all layers as one.

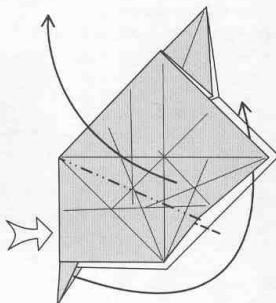

17. Abrir y aplastar.
Squash-fold.

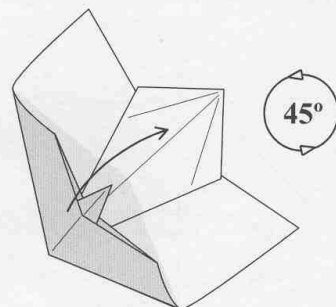

18. En proceso.
Intermediate step.

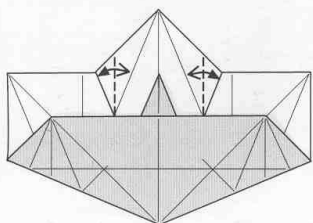

19. Marcar.
Crease.

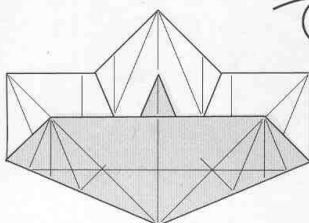

20.

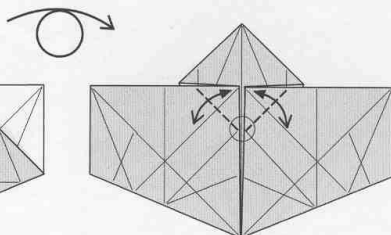

21. Marcar. Notar la referencia.
Crease. Note the reference point.



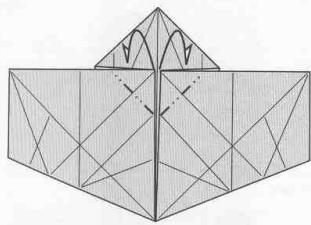

22. Hacer un doblez revertido.
Reverse-fold.

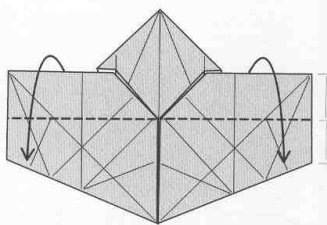

23. Doblar en valle abriendo el doblez del paso anterior.
Valley-fold, opening the reverse fold you just made.

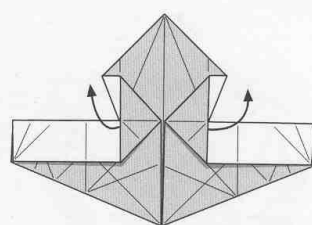

24. Desdoblar los dos pasos anteriores.
Unfold the two previous steps.

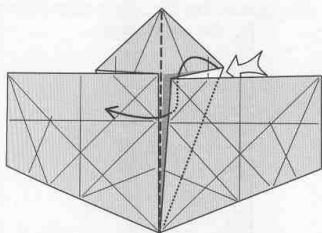

25. Revertir la mitad de la aleta pasándola hacia adelante del modelo.
Reverse-fold half of the flap so that it ends in front.

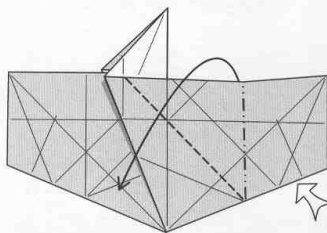

26. Abrir y aplastar siguiendo las líneas que se muestran.
Squash-fold following the creases shown.

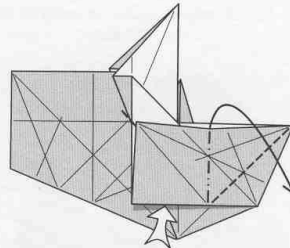

27. Abrir y aplastar siguiendo las líneas que se muestran.
Squash-fold following the creases shown.

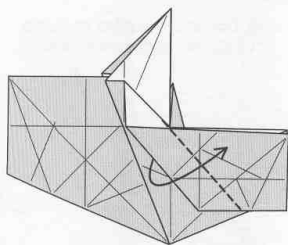

28. Doblar en valle marcando lo menos posible.
Valley-fold an edge creasing as little as possible.

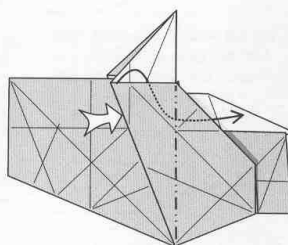

29. Revertir, regresando la aleta a su lugar.
Reverse-fold to return the flap to the position in step 25.

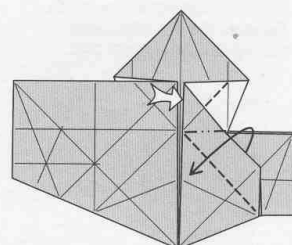

30. Regresar el borde a la posición del paso 28 mientras pivota una esquina.
Fold the corner back to the position from step 28 while swiveling down the top corner.

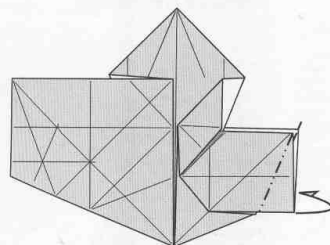

31. Revertir.
Reverse-fold.

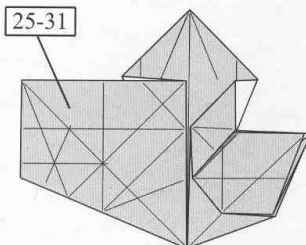

32.

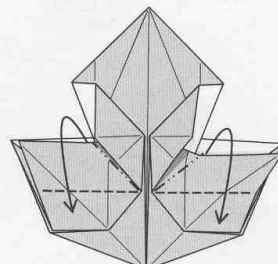

33. Doblar un borde liberando papel atrapado.
Fold an edge downwards while releasing some trapped paper.



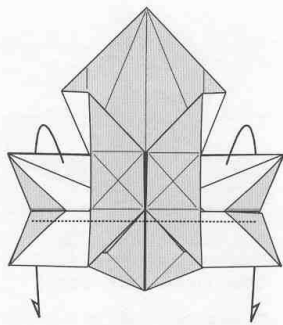

34. Doblar un borde hacia atrás usando una marca existente.
Fold an edge backwards using an existing crease.

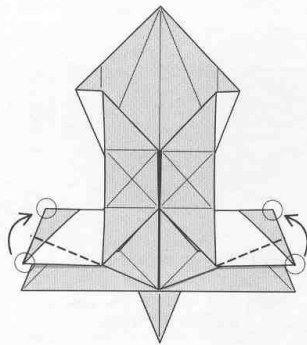

35. Doblar en valle.
Valley-fold these two points.

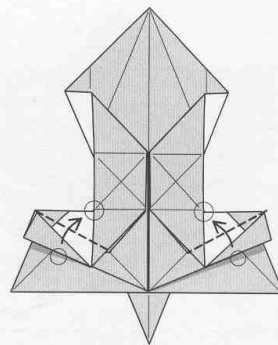

36. Doblar en valle de manera que el borde toque la intersección señalada.
Valley-fold so that the bottom edge touches the angle shown.

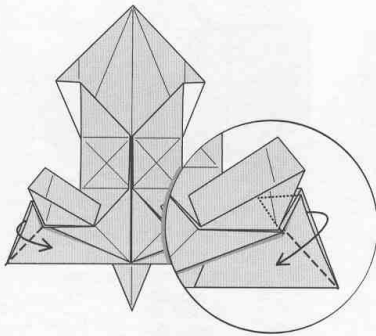

37. Tomar un solo borde y revertirlo.
Separate the two edges and reverse-fold the nearest one.

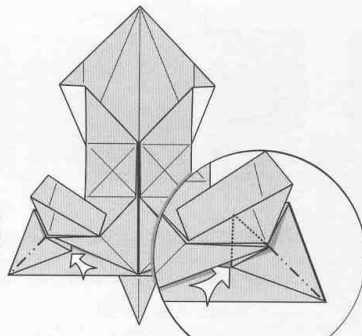

38. Hundir abierto. Se debe abrir parcialmente el modelo.
Open-sink. It is best to open the model partially.

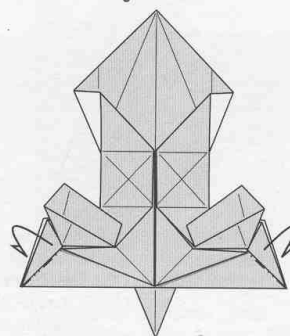

39. Doblar dos bordes en monte.
Fold two edges backwards.

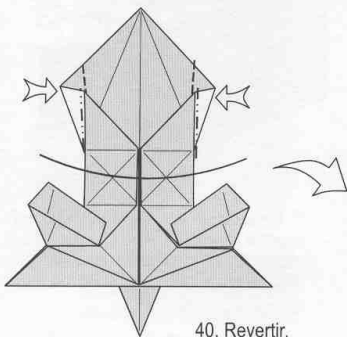

40. Revertir.
Reverse-fold.

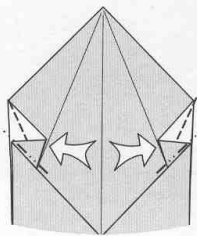

41. Revertir.
Reverse-fold.

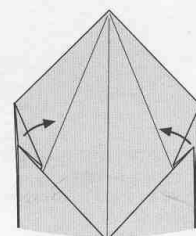

42. Desdoblar el paso anterior.
Unfold the previous step.

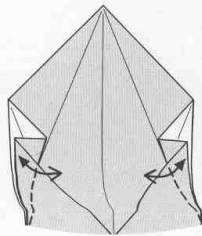

43. Doblar y desdoblar.
Fold and unfold.

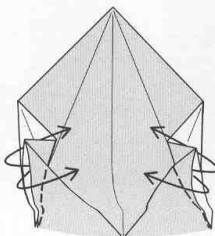

44. Revertir hacia afuera cambiando el color.
Outside reverse-fold to effect a color change.

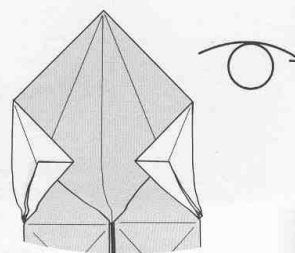

45.

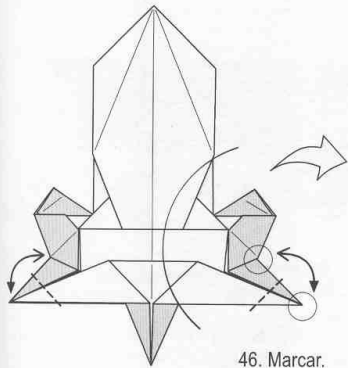

46. Marcar.
Crease.

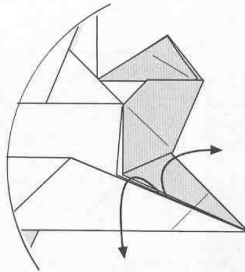

47. Abrir.
Open up some layers.

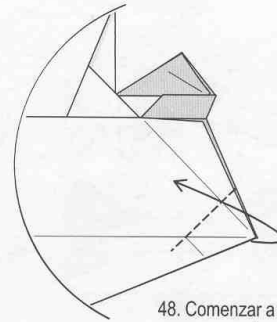

48. Comenzar a doblar
en valle.
Start valley-folding.

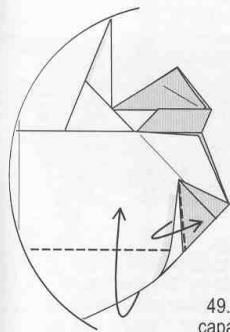

49. Cerrar las
capas de abajo.
Close the bottom
layers.

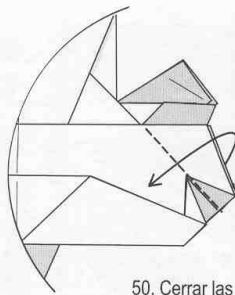

50. Cerrar las capas de
arriba.
Close the top layers.

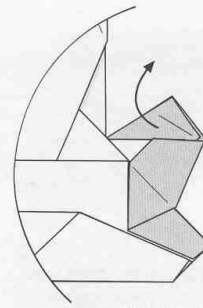

51. Desdoblar una capa.
Unfold a layer from the
front leg.

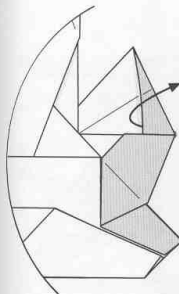

52. Liberar el
papel atrapado.
Pull out some
trapped paper.

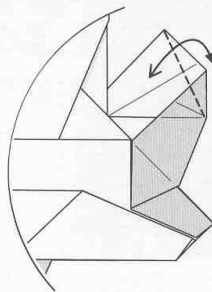

53. Marcar.
Crease.

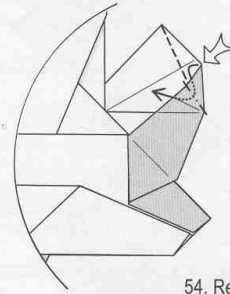

54. Revertir.
Reverse-fold.

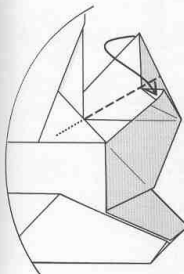

55. Meter la punta
en el espacio que
se indica.
Tuck the layer into
the pocket.

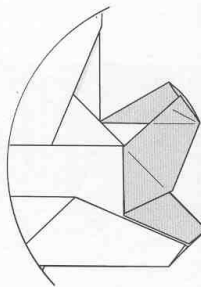

56.



47-56

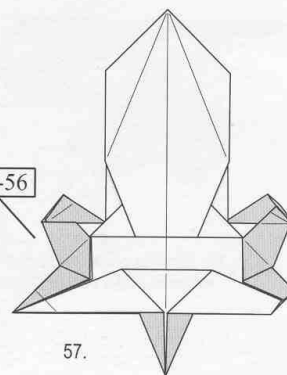

57.



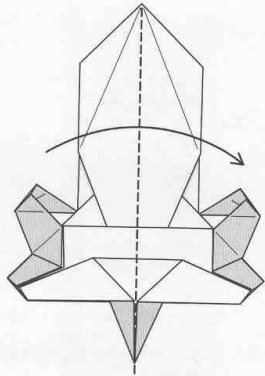

58. Doblar al medio.
Fold in half.

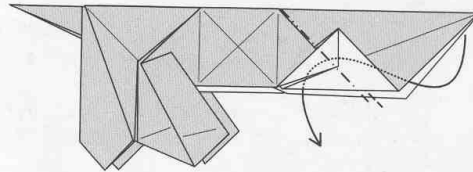

59. Revertir.
Reverse-fold.

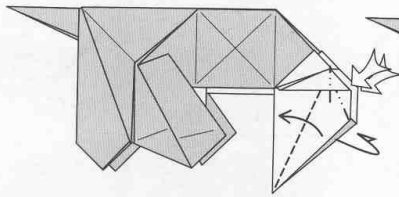

60. Revertir en ambos lados.
Reverse-fold on both sides.

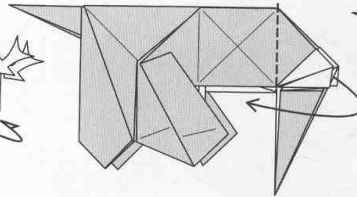

61. Abrir la cabeza.
Open the head.

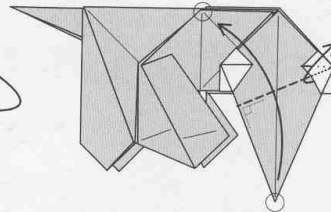

62. Doblar en valle mientras se levanta el colmillo del lado opuesto.
Valley-fold while lifting the tusk on the opposite side.

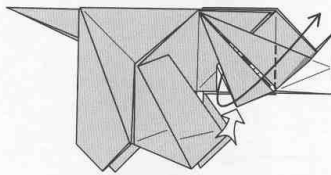

63. Doblar la trompa hacia la derecha mientras se levanta la punta del otro colmillo.
Swing the trunk to the right while lifting the tip of the other tusk.

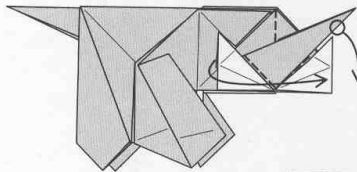

64. Bajar la trompa cerrando la cabeza.
Bring the trunk down while closing the head.

65. Revertir.
Reverse-fold.

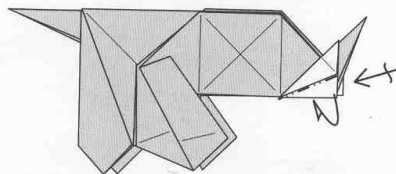
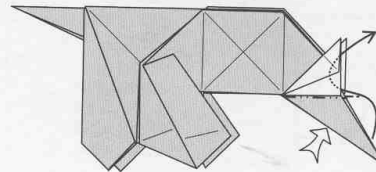

66. Revertir parte de los colmillos.
Reverse-fold a part of the tusks.

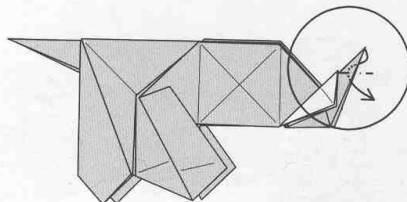

67. Revertir la punta.
Reverse-fold the tip.



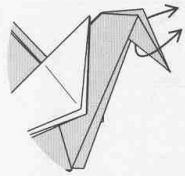

68. Liberar papel.
Pull out some paper from the inside.

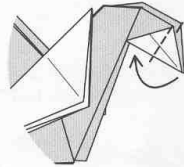

69. Revertir hacia afuera tapando el color blanco.
Outside reverse-fold the point hiding the white color.

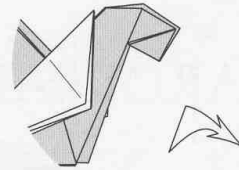

70.

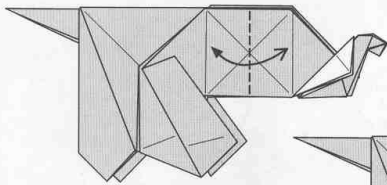

71. Marcar firmemente a través de todas las capas.
Fold and unfold firmly through all layers.

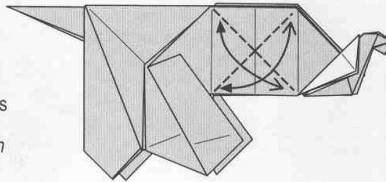

72. Marcar firmemente a través de todas las capas.
Fold and unfold firmly through all layers.

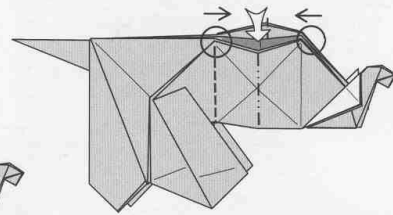

73. Hundir la capa central formando las orejas con las capas laterales.
Sink the central layer of the head while forming the ears.

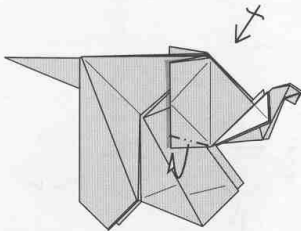

74. Doblar dos capas juntas para trabar las orejas.
Mountain-fold two layers as one to lock the ears.

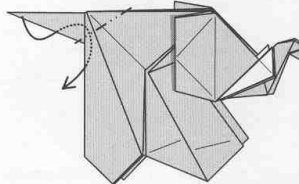

75. Revertir en el lomo y la cola.
Reverse-fold the back and the tail.

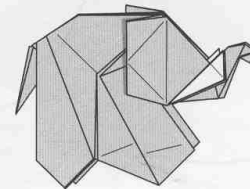

76.

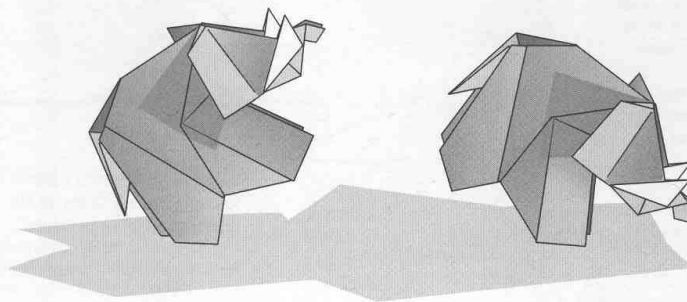

CARDENAL

CARDINAL

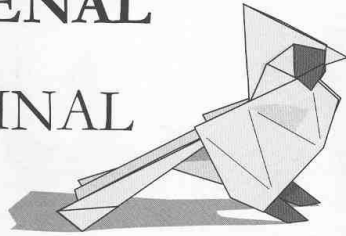

ratio: 0.44

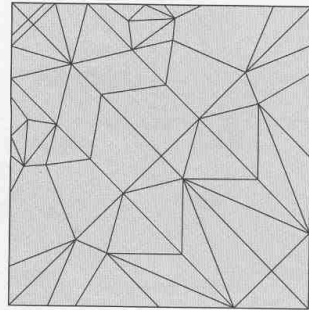
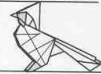

Nivel 3

Papel favorito: Kami rojo y negro.

Tamaño recomendado: 20 cm.

Comentarios: doblar en seco.

Level 3

Favorite paper: Red and black kami.

Recommended size: 20 cm.

Comments: dry-fold.

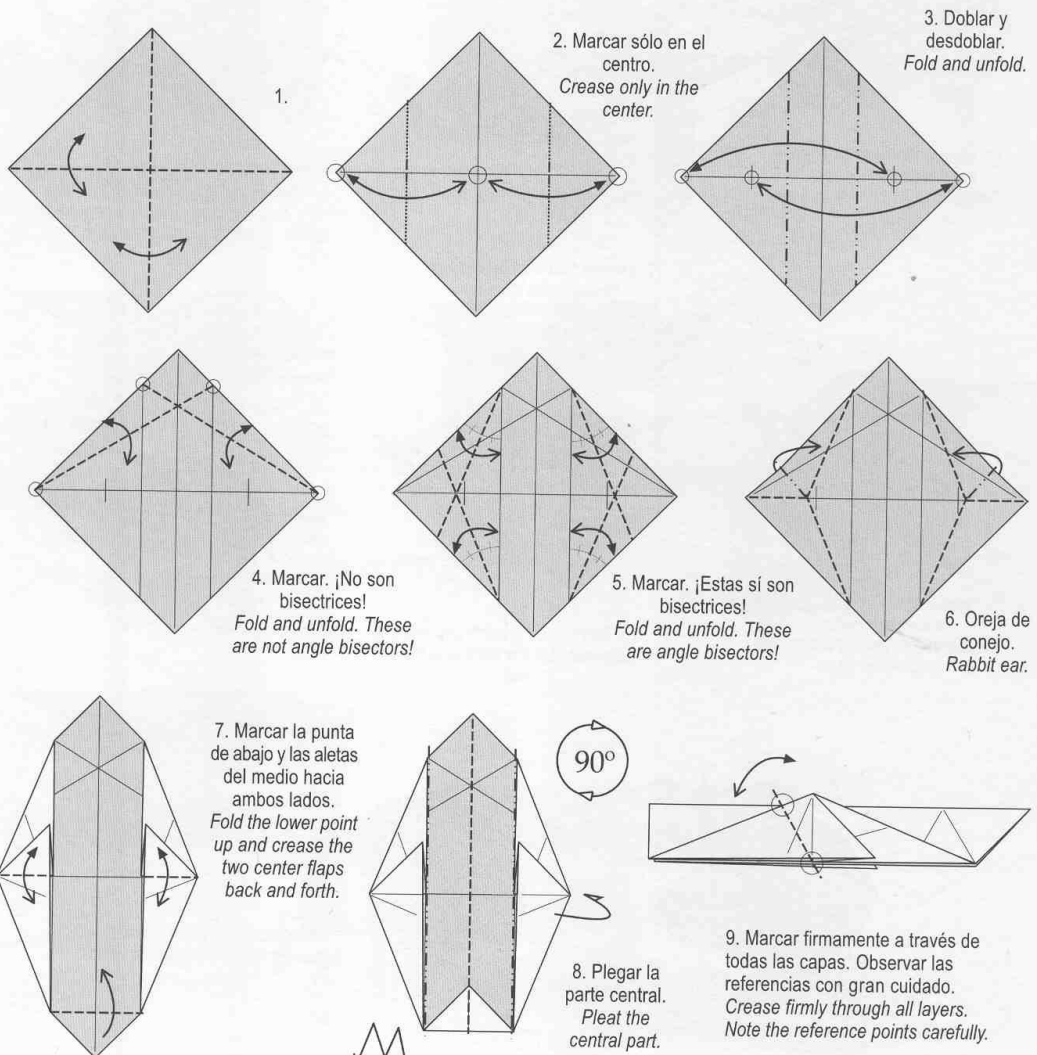

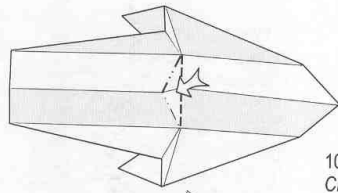

10. Escalonar las capas internas.
Crimp the internal layers.

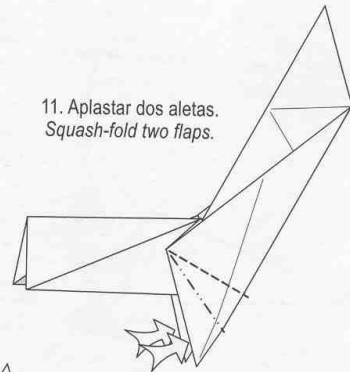
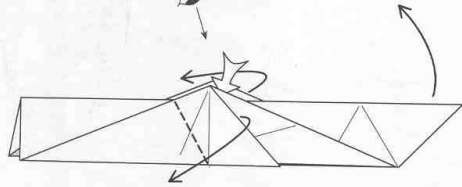

11. Aplastar dos aletas.
Squash-fold two flaps.

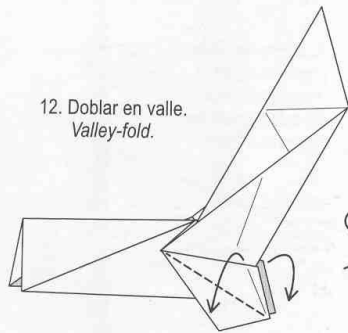

12. Doblar en valle.
Valley-fold.

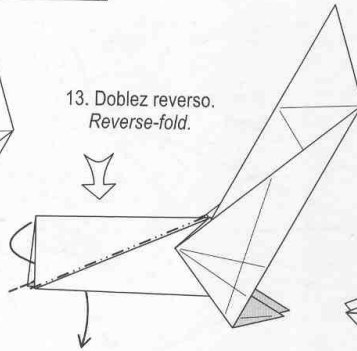

13. Doblez reverso.
Reverse-fold.

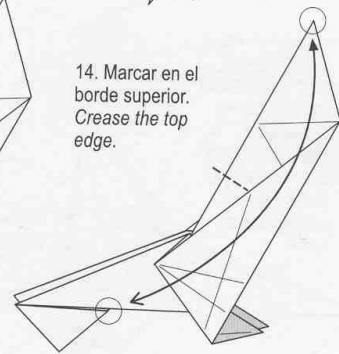

14. Marcar en el borde superior.
Crease the top edge.

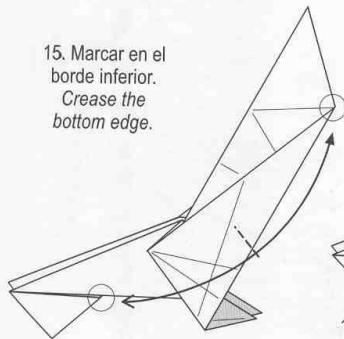

15. Marcar en el borde inferior.
Crease the bottom edge.

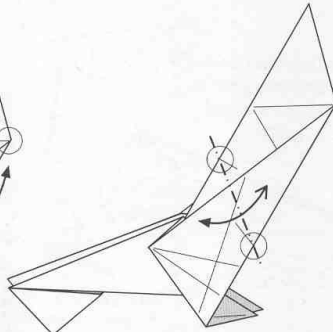

16. Marcar firmemente a través de todas las capas. Observar las referencias con exactitud.
Crease firmly through all layers. Take care to use the reference points.

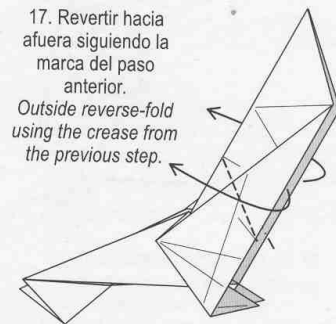

17. Revertir hacia afuera siguiendo la marca del paso anterior.
Outside reverse-fold using the crease from the previous step.

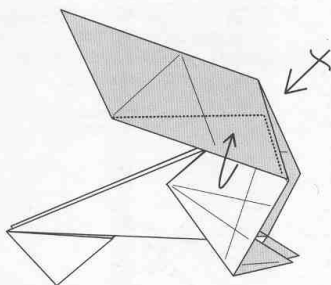

18. Liberar papel atrapado.
Release some trapped paper.

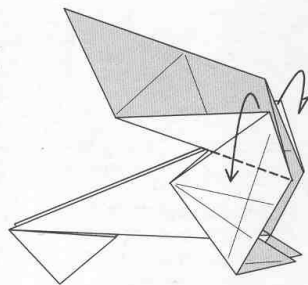

19. Doblar en valle.
Valley-fold.

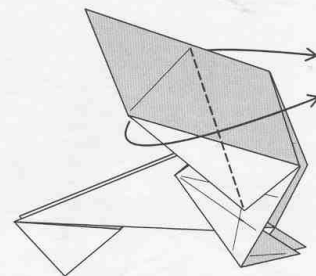

20. Revertir hacia afuera siguiendo una marca existente. No intentar que los bordes coincidan, simplemente seguir la marca.
Outside reverse-fold using a pre-existing crease. Do not try to make the edges match, just follow the crease.



21. Liberar papel atrapado.
Release some trapped paper.

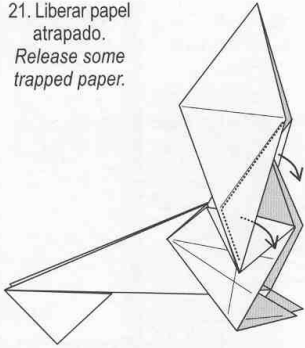

22. Marcar una pequeña bisectriz en la esquina inferior.
Crease a small angle bisector on the bottom corner.

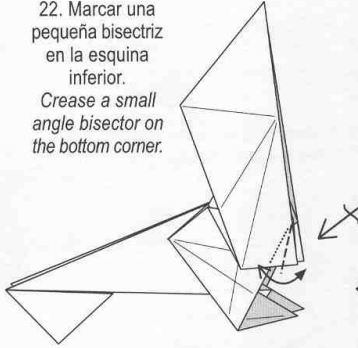

23. Marcar a través de una sola capa.
Observar las referencias con mucho cuidado.
Crease through one layer only.
Note the references very carefully.

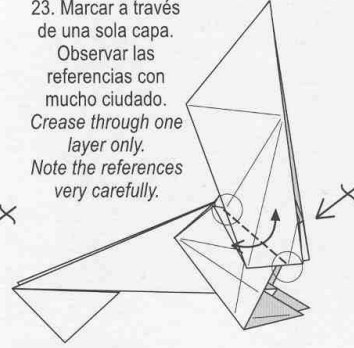

24. Doblar en valle.
No emparejar bordes, simplemente seguir la marca existente.
Valley-fold. Do not match the edges, just follow the existing crease.

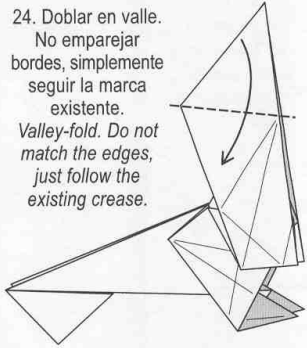

25. Bisectar.
Bisect.

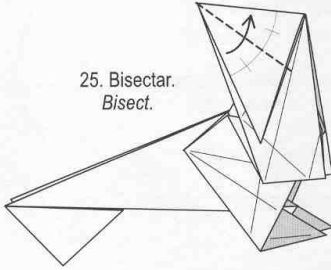

26. Doblar en valle empezando en la esquina inferior.
Valley fold starting from the bottom corner.

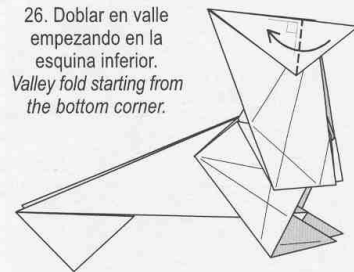

28. Desdoblar los 4 pasos anteriores.
Unfold the previous 4 steps.

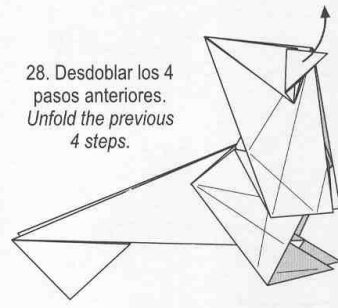
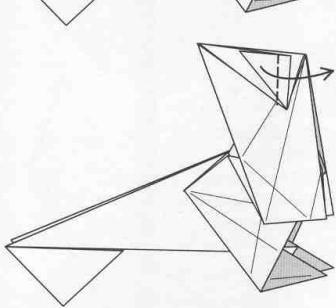

29. Escalonar.
Crimp-fold.

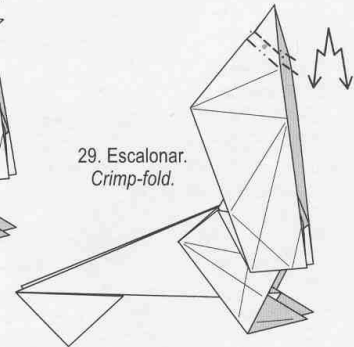

27. No hay referencia exacta. Una pequeña punta del pico tiene que sobresalir del borde.
There is no exact reference. The tip of the beak has to go a little beyond the edge.

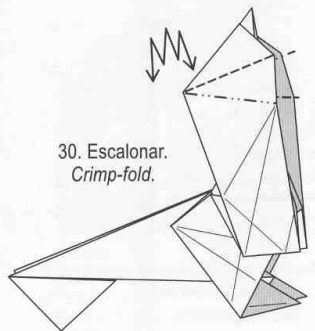

30. Escalonar.
Crimp-fold.

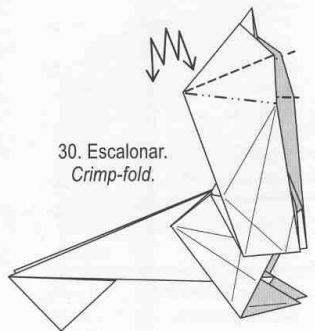

31. Empujar suavemente de abajo hacia arriba permitiendo que los dobleces caigan en su lugar naturalmente.
Push gently from the bottom up allowing the folds to fall naturally into place.

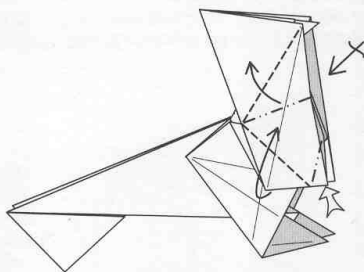

32. Doblar la cola metiéndola detrás de las alas. Afinar las patas.
Valley-fold the tail, tucking it behind the wings. Narrow the legs.

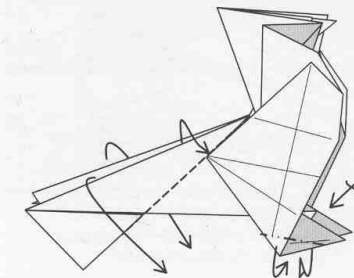

33. Bajar el hombro marcando el papel lo menos posible.
Push the shoulder down creating the paper as little as possible.

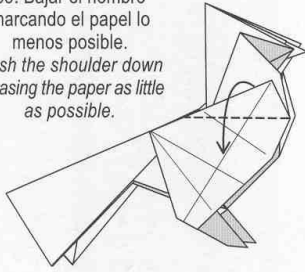

34. Pivotar siguiendo las referencias.
Swivel-fold, using the reference points.

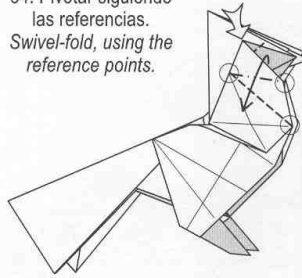

35. Volver el hombro a su lugar.
Raise the shoulder back up.

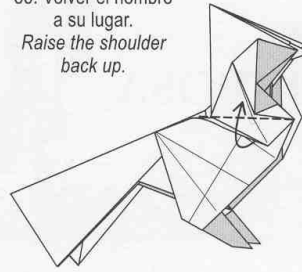

36

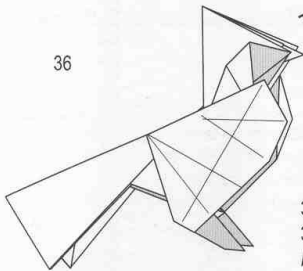

33-35

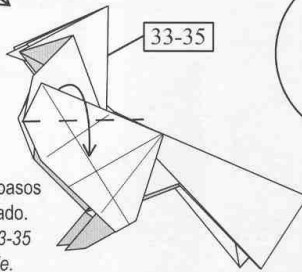

37. Repetir los pasos 33-35 del otro lado.
Repeat steps 33-35 on the other side.

38

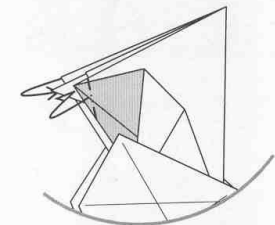
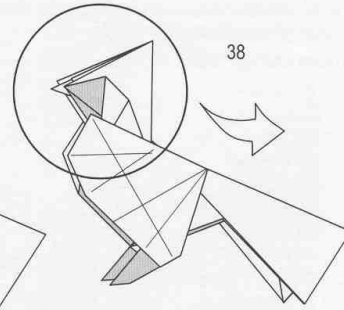

39. Doblar las puntas y meterlas entre dos capas del pico.
Mountain-fold the points and tuck them between the layers of the beak.

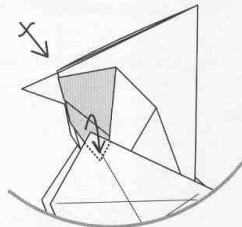

40. Liberar una punta oculta.
Release a hidden point.

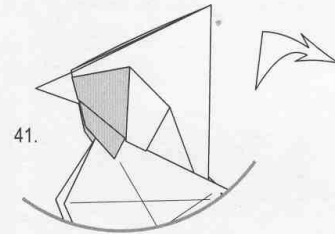

41.

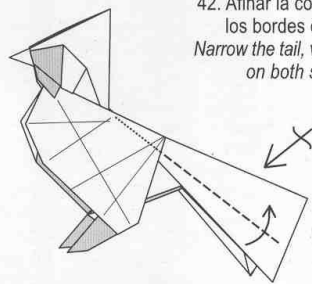

42. Afinar la cola doblando los bordes en valle.
Narrow the tail, valley-folding on both sides.

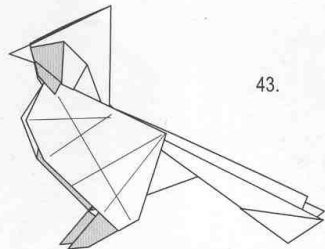

43.

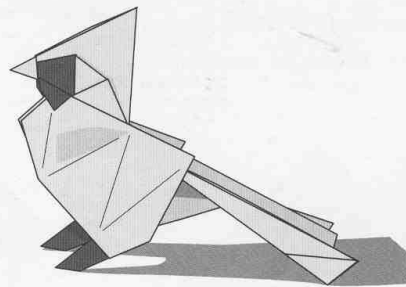

RAPOSA

VIXEN

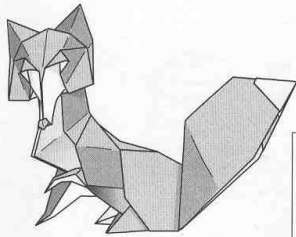

ratio: 0.4

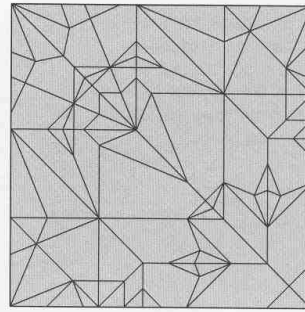

Nivel 3

Papel favorito: Tant rojo, pintado de blanco en una cara.

Tamaño recomendado: 25 cm.

Comentarios: doblar en seco.

Level 3

Favorite paper: red Tant paper, painted white on one side.

Recommended size: 25 cm.

Comments: dry-fold.

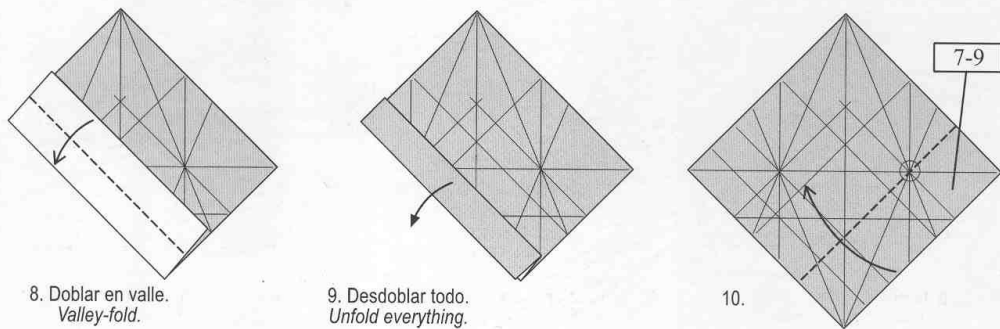
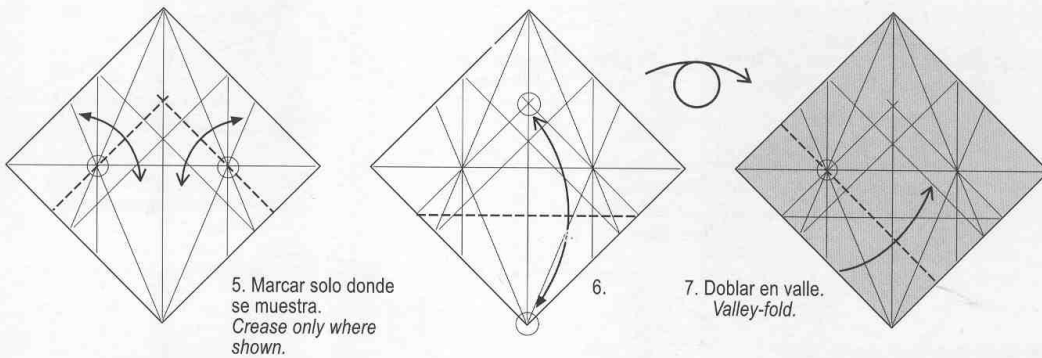
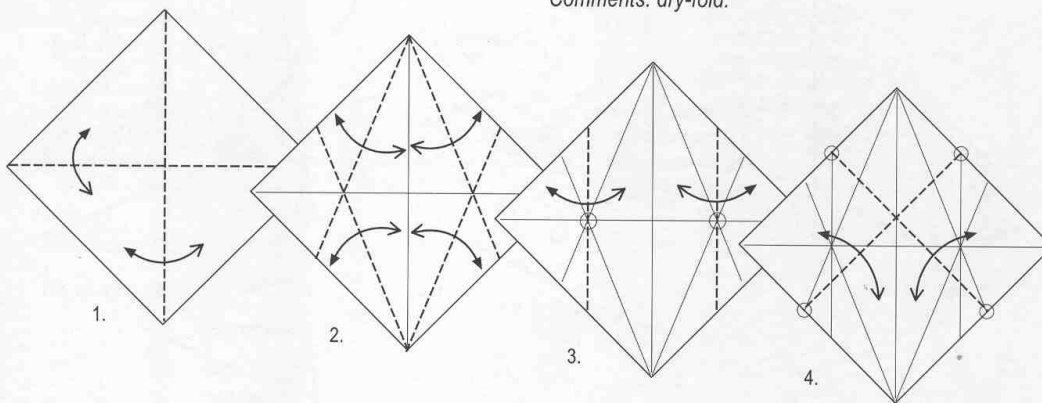

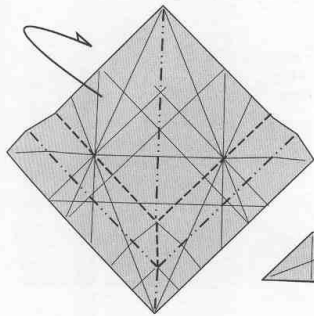

11. Colapsar.
Collapse.

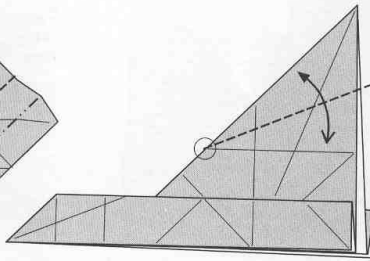

12. Marcar una bisectriz.
Create an angle bisector.

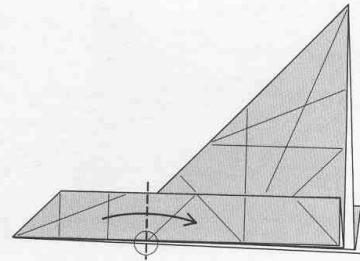

13. Buscar la referencia en el borde inferior solamente.
Look for a reference line on the bottom edge only.

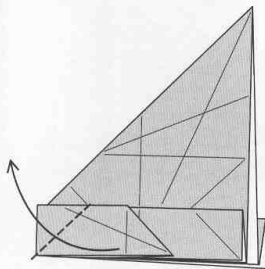

14. Doblar en valle.
Valley-fold.

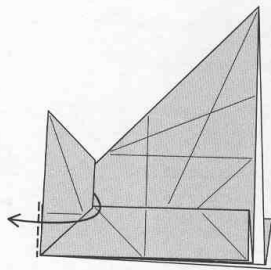

15. Doblar el conjunto hacia la izquierda.
Swing the group to the left.

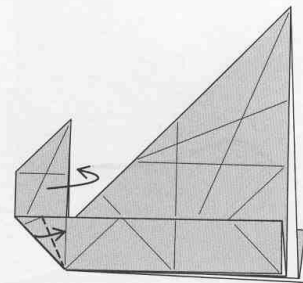

16. Doblar en valle permitiendo que la cola rote.
Valley-fold, allowing the tail to pivot.

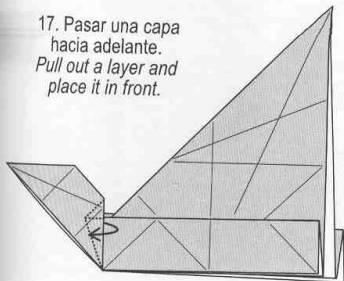

17. Pasar una capa hacia adelante.
Pull out a layer and place it in front.

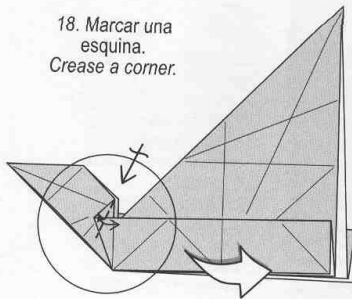

18. Marcar una esquina.
Crease a corner.

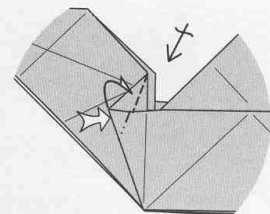

19. Revertir sobre las marcas del paso anterior.
Reverse-fold using the creases from last step.

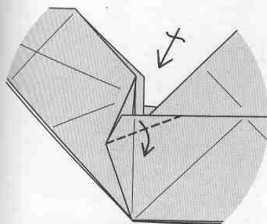

20. Doblar en valle.
Valley-fold.

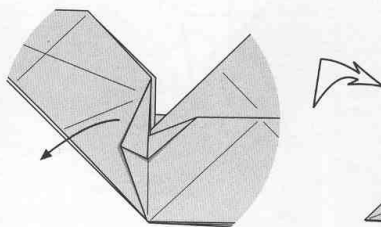

21. Desdoblar hasta el paso 13.
Unfold to step 13.

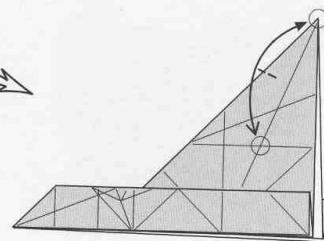

22. Marcar sólo en el borde de arriba.
Just pinch the top edge.



23. Abrir un borde para ver debajo.
Open an edge down to look behind it.

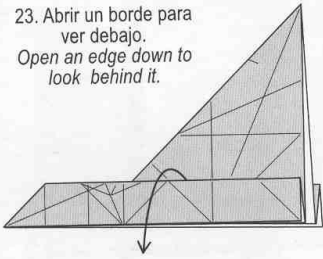

24. Marcar una bisectriz.
Crease through an angle bisector.

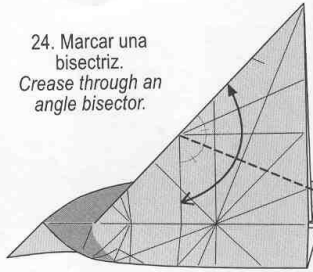

25. Seguir las referencias con cuidado.
Follow the references carefully.

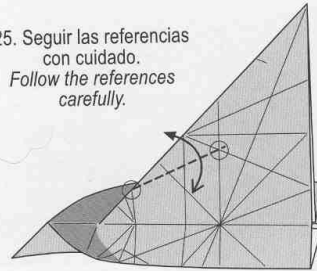

26. Devolver el borde a su lugar.
Fold the edge back into place.

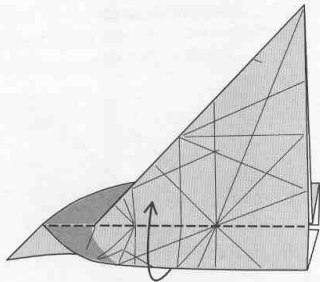

27. Escalonar.
Crimp.

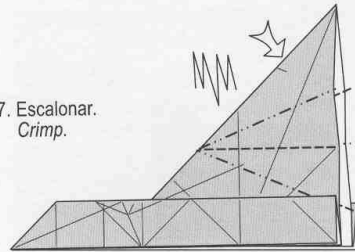

28. Marcar a través de todas las capas.
Crease firmly through all layers.

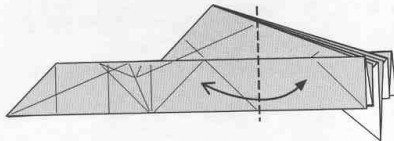

29. Desdoblar hasta el paso 27.
Unfold to step 27.

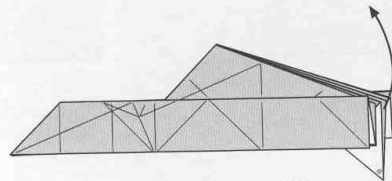

30. Levantar la cola a la posición del paso 18, esta vez haciendo los dobleces por dentro en forma de un escalonado simétrico de cada lado.
Lift the tail to the position in step 18. This time make the folds for each double layer as symmetrical crimps.

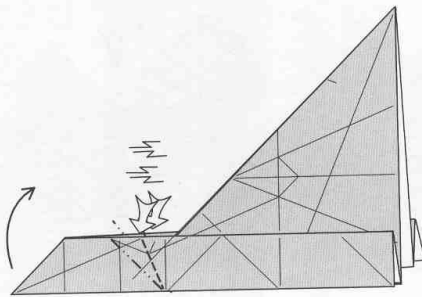

31. Ver el detalle en el próximo paso.
Look at the close-up in the next step.

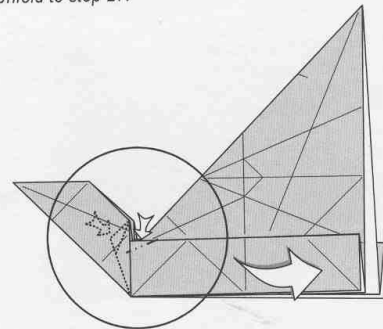

32. Hundir en dos lados al mismo tiempo usando las marcas del paso 21.
Sink in two places at the same time, finishing up in the position from step 21.

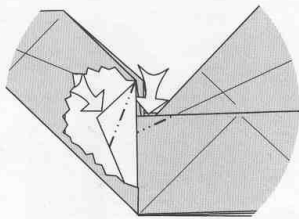

33.

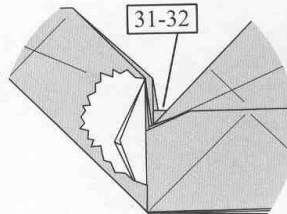

34. Abrir la cola para trabajar en el interior.
Open the tail to work inside.

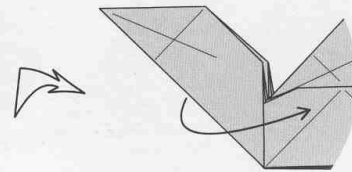

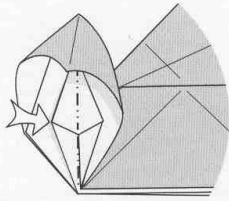

35. Hundir cerrado.
Closed-sink.

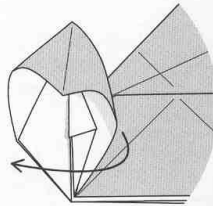

36. Cerrar nuevamente.
Close up again.

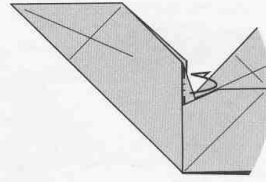

37. Doblar un borde en monte, entre las capas de la cola.
Mountain-fold an edge, between the layers of the tail.

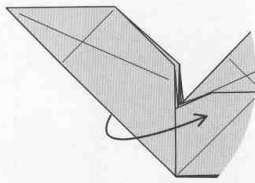

38. Abrir nuevamente.
Open again.

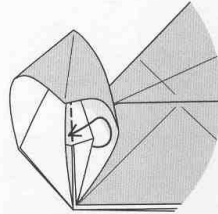

39. Meter la aleta en un bolsillo. Esto trabará el conjunto de la cola muy firmemente.
Tuck the flap into the pocket. This will lock the tail very firmly.

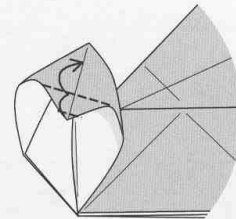

40. Antes de cerrar la cola, doblar la punta para hacer el cambio de color.
Before closing the tail, fold the point up for a color change.

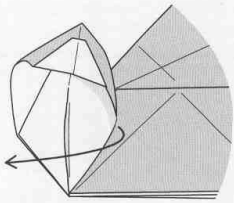

41. Cerrar nuevamente.
Close up again.

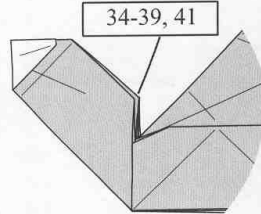

42.

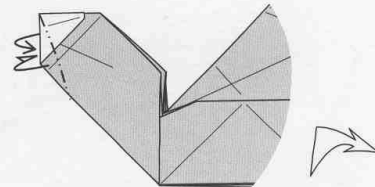

43. Doblar las esquinas en monte.
Mountain-fold the corners.

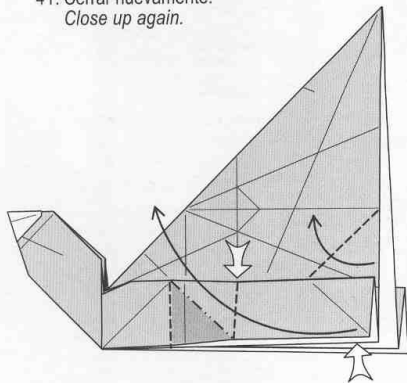

44. Esto es un doblez múltiple. Empujar un borde hacia abajo mientras se abre la punta del papel.
This is a multiple fold. Push an edge down while opening the corner of the paper.

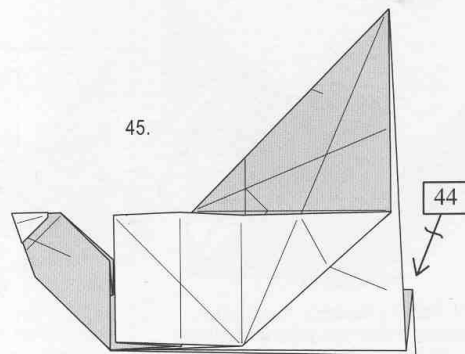

45.



46. Doblar en valle.
Valley-fold.

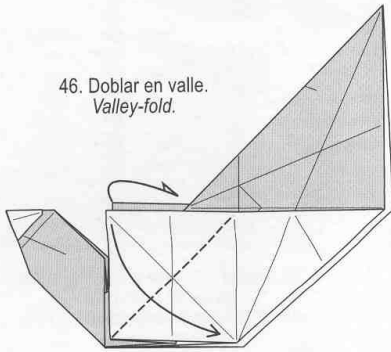

47. Revertir hacia afuera.
Outside reverse-fold.

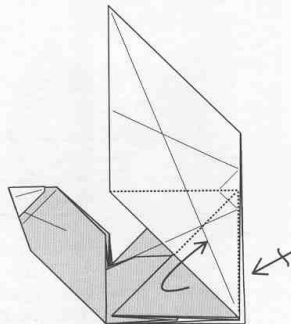
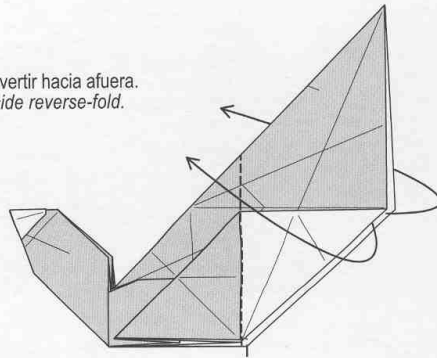

48. Sacar el papel atrapado.
Pull out some trapped paper.

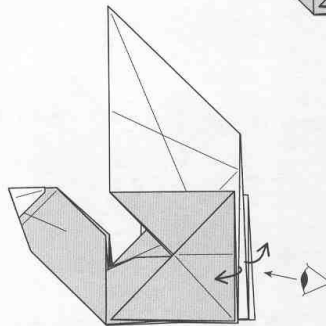

49. Abrir un poco las capas del medio y ver desde el frente.
Open the central layers a bit, and view from the front.

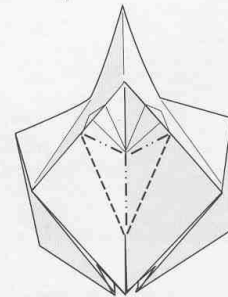

50. Empujar ligeramente desde atrás para colocar las líneas en la dirección en que se muestran.
Push a bit from behind the point where the creases meet.

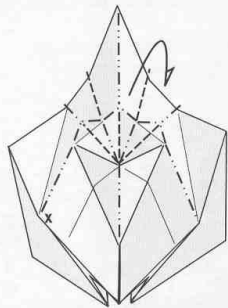

51. Continuar colapsando según las líneas.
Continue collapsing using the lines shown.

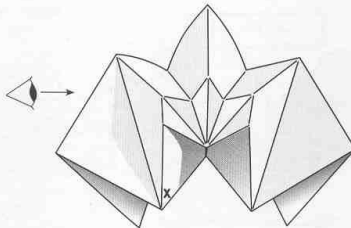

52. En proceso. Pasar luego a vista lateral.
In progress. Go to a lateral view.

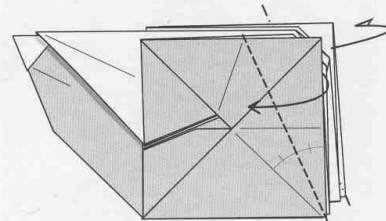

53. Doblar en valle.
Valley-fold.

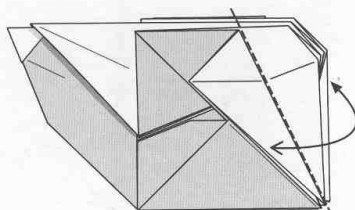

54. Doblar y desdoblar marcando firmemente a través de todas las capas.
Fold and unfold creasing firmly through all layers.

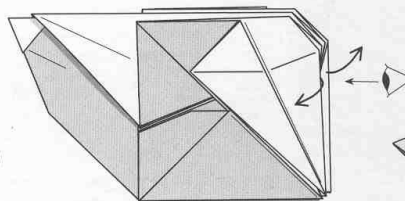

55. Abrir un poco las capas del medio y ver desde el frente.
Open the central layers a bit and view from the front.

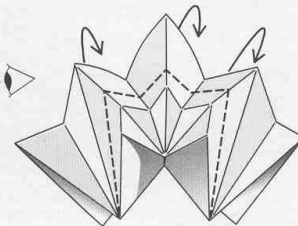

56. Hacer un doblez revertido hacia afuera usando las líneas del paso 54.
Outside-reverse fold using the creases from step 54.



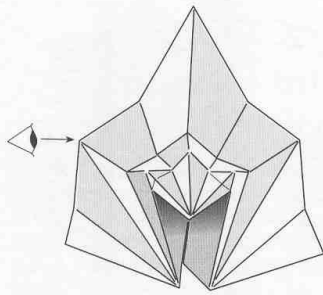

57. En proceso. Pasar luego a vista lateral.
In progress. Go to a lateral view.

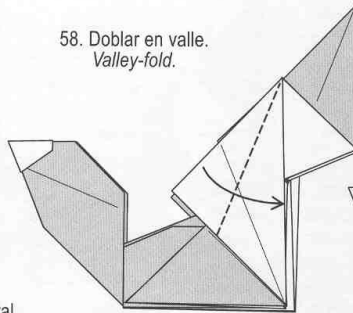

58. Doblar en valle.
Valley-fold.

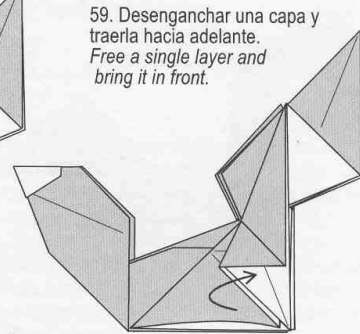

59. Desenganchar una capa y traerla hacia adelante.
Free a single layer and bring it in front.

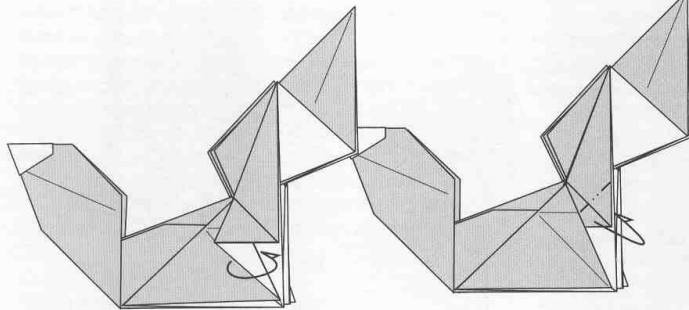

60. Doblar la solapa blanca hacia atrás.
Fold the little white flap behind.

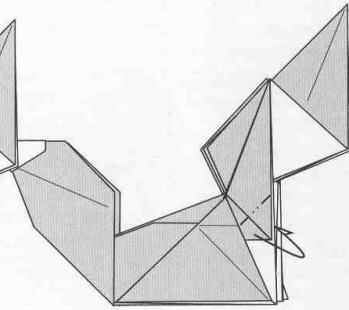

61. Doblar la esquina hacia adentro tanto como se pueda.
Mountain-fold the corner behind as far as it will go.

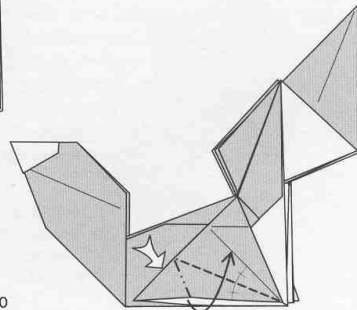

62. Pivotar.
Swivel-fold.

63. Pivotar un poco de papel hacia adentro. En el siguiente paso, comprobar cómo el borde superior de este doblez termina quedando horizontal.
Swivel-fold some paper behind the foot. On the next step, note the horizontal position of the top edge of this fold.

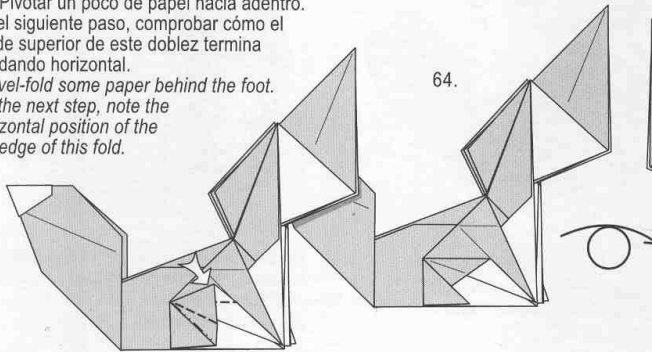

64.

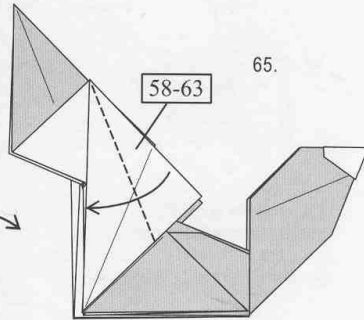

65.

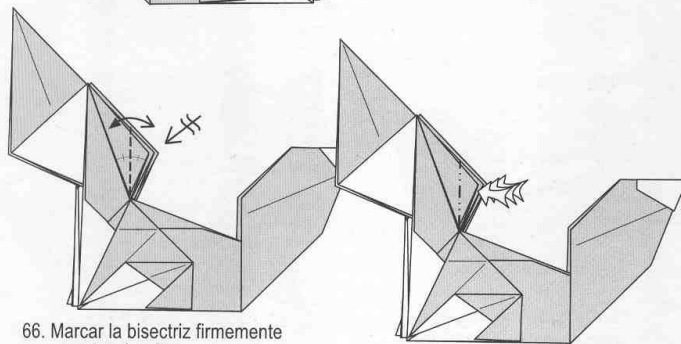

66. Marcar la bisectriz firmemente en estos tres bordes.
Create firmly through the angle bisector on these three edges.

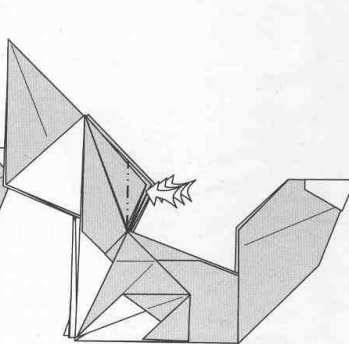

67. Hundir abierto tres bordes.
Open-sink three edges.

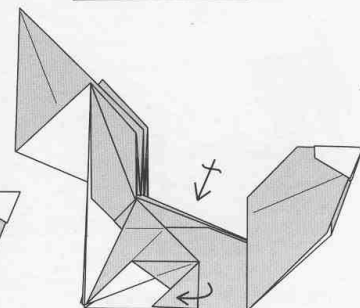

68. Pasar una capa de atrás hacia adelante de cada pata trasera cuidadosamente.
Carefully bring a layer to the front of each hind leg.



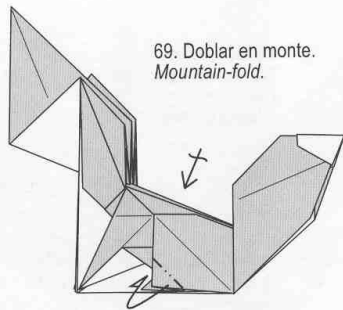

69. Doblar en monte.
Mountain-fold.

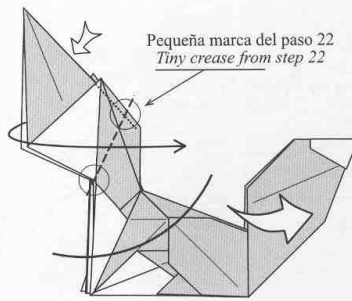

70. Abrir y aplastar la cabeza.
Squash-fold the head.

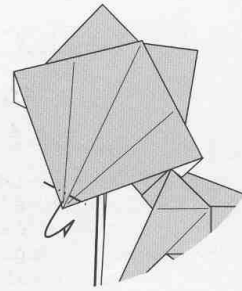

71. Doblar en monte sin referencia.
Mountain-fold. There is no reference.

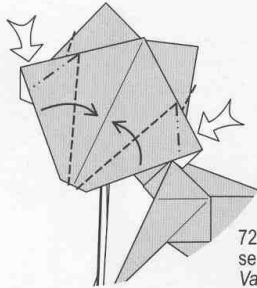

72. Doblar en valle mientras se aplastan las mejillas.
Valley-fold while squashing the cheeks.

El triángulo blanco no debe pasar más allá del borde del hocico.
The white triangle must not go beyond the edge of the snout.

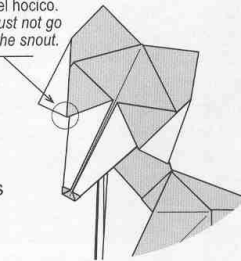

73.

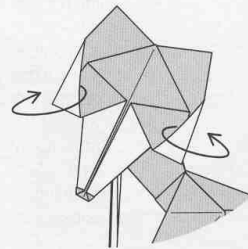

74. Envolver con mucho cuidado cambiando el color.
Very carefully wrap around to change the color.

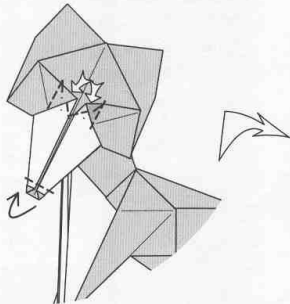

75. Dar vuelta la nariz y aplastar formando los ojos.
Swing the nose up, squash-fold forming the eyes.

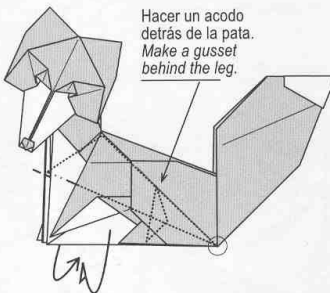

Hacer un acodo detrás de la pata.
Make a gusset behind the leg.

76. Ocultar los dos bordes centrales tanto como se pueda.
Hide the two central edges as far as they will go.

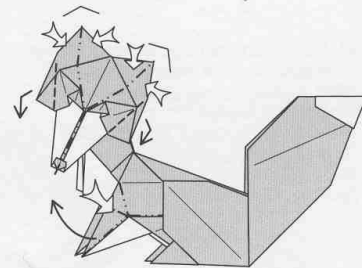

77. Modelar la cabeza con facetas bien definidas.
Hacer una doble oreja de conejo en una pata.
Shape the head with well defined facets. Double-rabbit ear one leg.

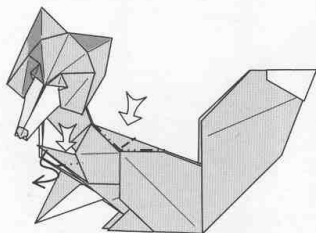

78. Revertir la punta de la pata. Dar volumen al cuerpo aplanando un rombo sobre el lomo.
Reverse-fold the leg. Make the body 3-D by flattening a rhombus shape at the back.

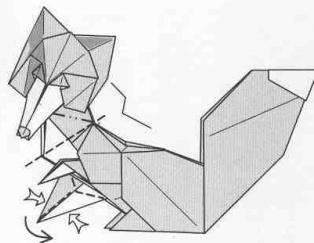

79. Posicionar la cabeza con dobleces rectos bien definidos. Dar forma a la otra pata.
Position the head with well defined straight folds. Shape the other leg.

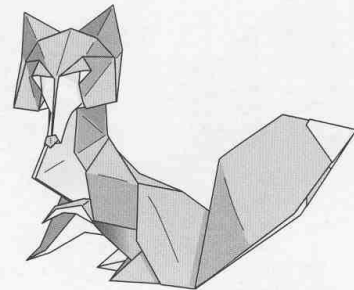

80.



PIRAMIDE

PYRAMID

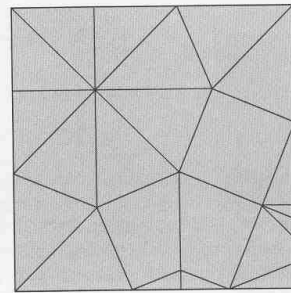
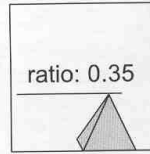
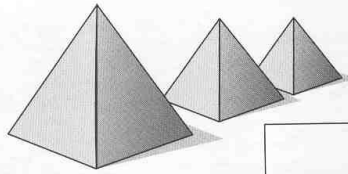

Nivel 1
Papel favorito: Tant.
Tamaño recomendado: 20 cm.
Comentarios: doblar en seco.

Level 1
Favorite paper: Tant.
Recommended size: 20 cm.
Comments: dry-fold.

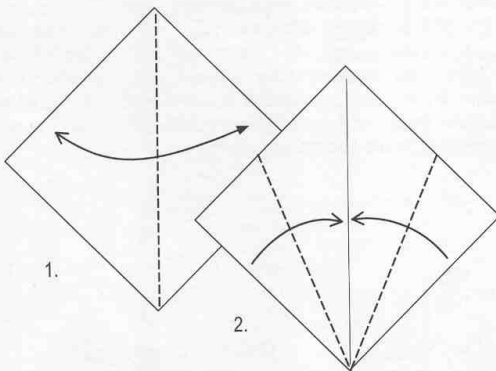

1.

2.

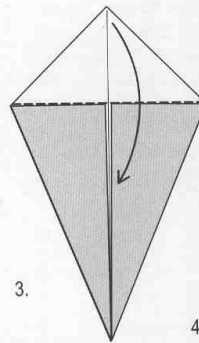

3.

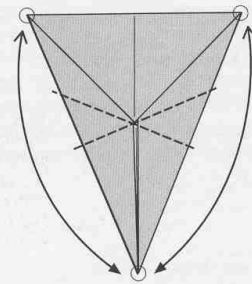

4. Marcar llevando la punta hasta las esquinas.
Crease, folding the tip to the corners.

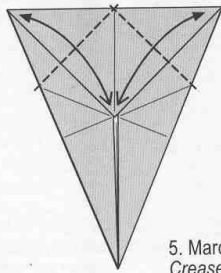

5. Marcar.
Crease.

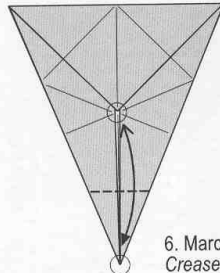

6. Marcar.
Crease.

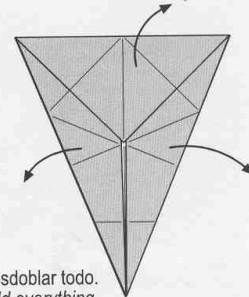

7. Desdoblar todo.
Unfold everything.

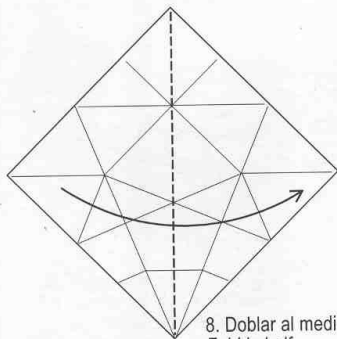

8. Doblar al medio.
Fold in half.

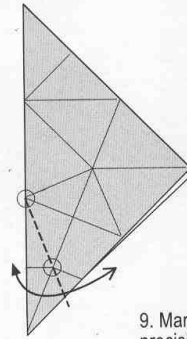

9. Marcar con precisión.
Crease.

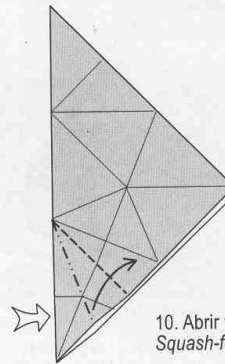

10. Abrir y aplastar.
Squash-fold.



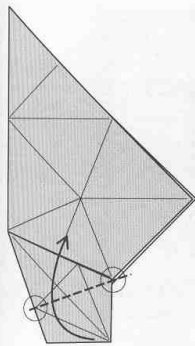

11. Doblar en valle a través de todas las capas.
Valley-fold through all layers.

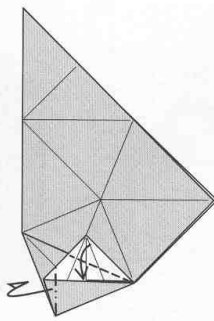

12. Doblar la punta en valle y una esquina en monte.
Valley-fold one corner and mountain-fold another.

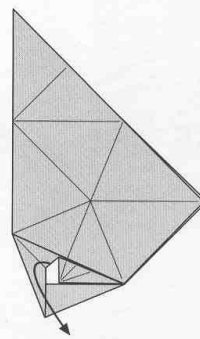

13. Desdoblar sólo el paso 11.
Unfold step 11 only.

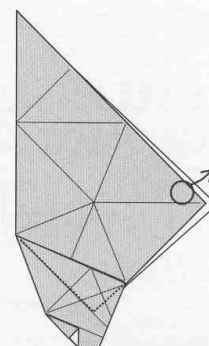

14. Tirar de la capa de encima liberando papel. No aplanar.
Pull the top layer out, releasing some trapped paper. Do not flatten.

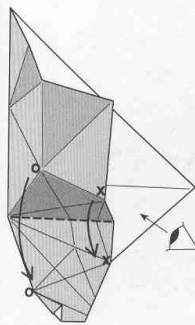

15. Con un doblez en valle, juntar los puntos "x" y los puntos "o".
With one valley fold, bring "x" to "x" and "o" to "o".

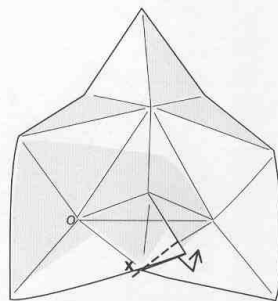

16. Doblar en valle.
Valley-fold.

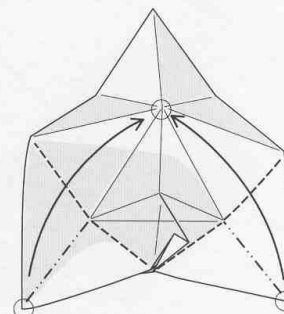

17. Llevar las puntas hasta la intersección que se muestra.
Fold the points to the indicated intersection.

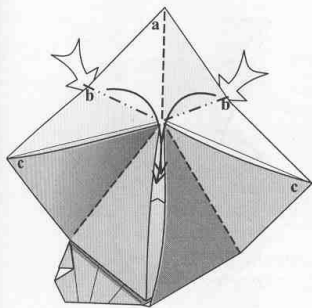

18. Formar la traba llevando los puntos "b" al centro, delante de la abertura.
Start forming the lock, taking points "b" to the center, right in front of the opening.

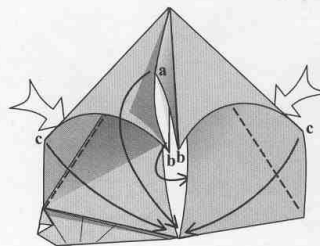

19. Introducir los puntos "b" en la abertura. Notar las posiciones finales en el siguiente dibujo.
Tuck points "b" into the opening. Note the final positions in the next drawing.

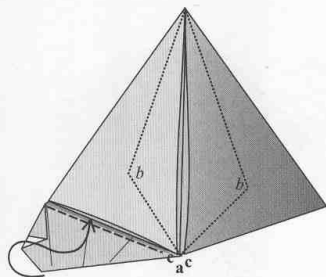

20. Terminar de cerrar la pirámide metiendo la aleta en un bolsillo.
Complete the pyramid by tucking the flap into a pocket.

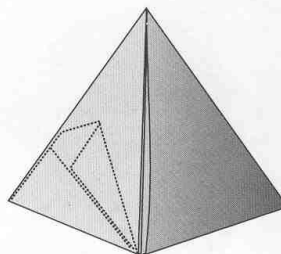

21.



GALLINAS GEOMETRICAS

GEOMETRIC HENS

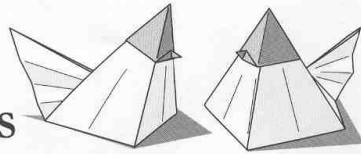

ratio: 0.41

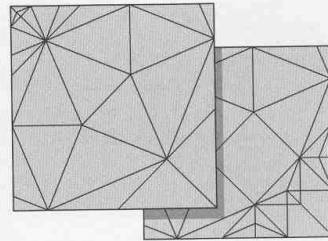
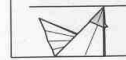

Nivel 2
Papel favorito: papel kami blanco o decorado y rojo en la otra cara.
Tamaño recomendado: 15 a 20 cm.
Comentarios: doblar en seco.

Level 2
Favorite paper: patterned or white kami, red on the other side.
Recommended size: 15 to 20 cm.
Comments: dry-fold.

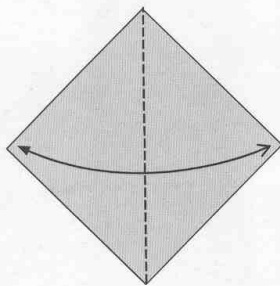

1. Comenzar con el color rojo hacia arriba.
Start with the red side up.

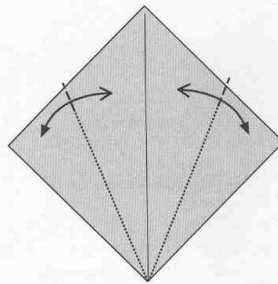

2. Marcar solamente en los bordes.
Just pinch at the edges.

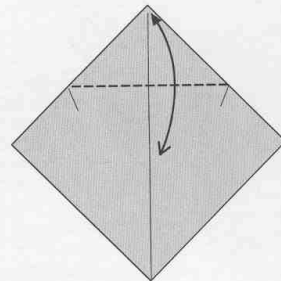

3.

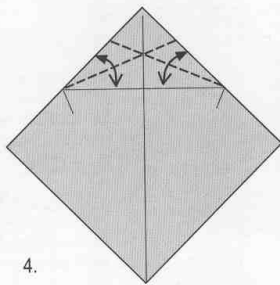

4.

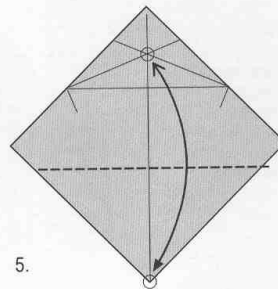

5.

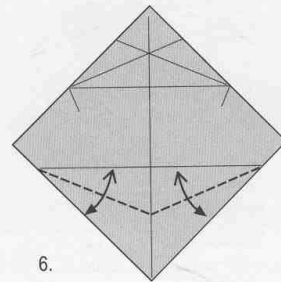

6.

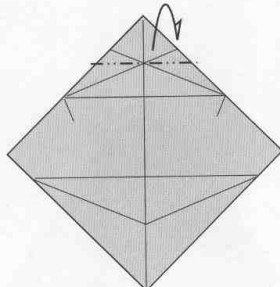

7. Doblar en monte.
Mountain-fold.

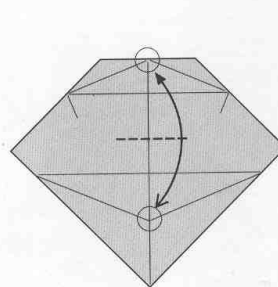

8. No se necesita marcar toda la longitud.
It is not necessary to create the full width.

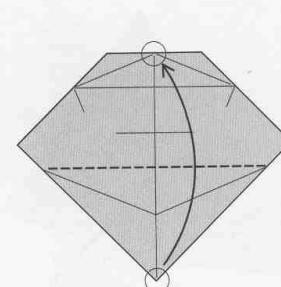

9. Doblar en valle como en el paso 5.
Valley-fold as in step 5.



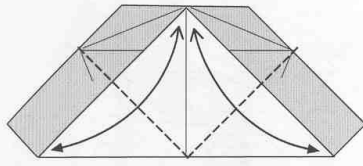

10. Marcar.
Crease.

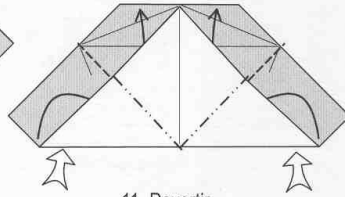

11. Revertir.
Reverse-fold.

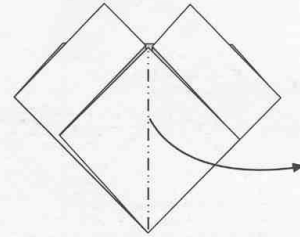

12. Desdoblar la punta.
Unfold to corner.

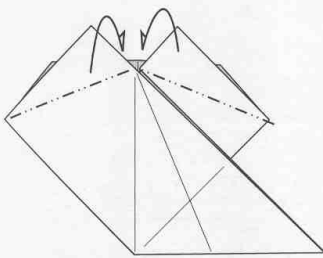

13. Doblar en monte una capa.
Mountain-fold one layer.

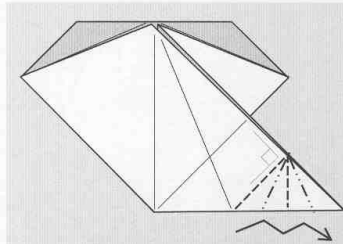

14(2). Sólo para la segunda gallina, hacer estos dobleces y luego seguir con los pasos 17 al 25.
For the second hen only, make these creases, then go directly to steps 17 to 25.

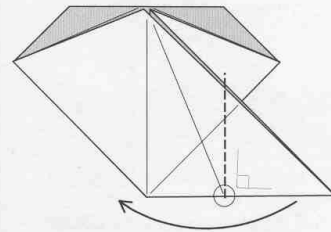

14. Doblar en valle. Buscar la referencia en el borde inferior solamente.
Valley-fold. Look for your reference on the bottom edge only.

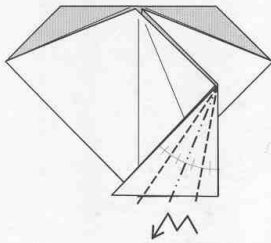

15. Escalonar en cuatro.
Pleat into quarters.

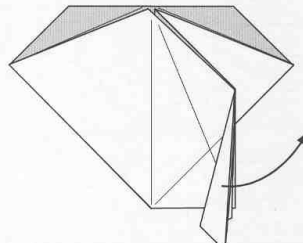

16. Desdoblar.
Unfold.

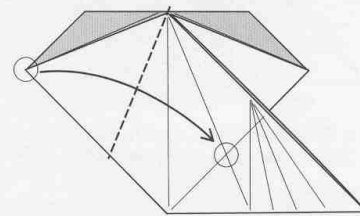

17. Doblar en valle.
Valley-fold.

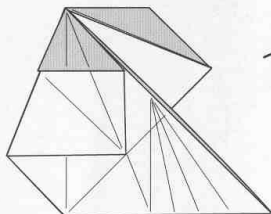

18.

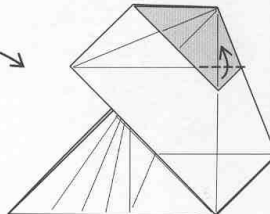
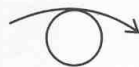

19. Doblar en valle.
Valley-fold.

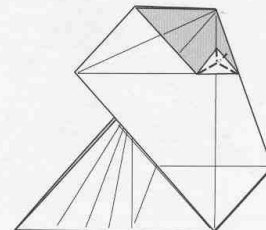

20. Formar el pico con una pequeña oreja de conejo.
Make the beak with a little rabbit-ear.



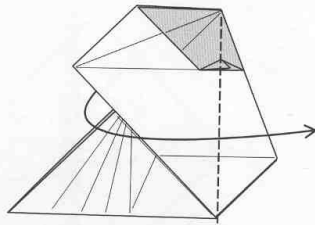

21. Doblar en valle. Mantener el pico doblado.
Valley-fold. Keep the beak folded.

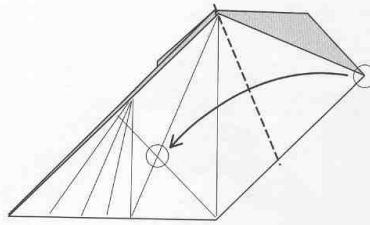

22. Doblar en valle.
Valley-fold.

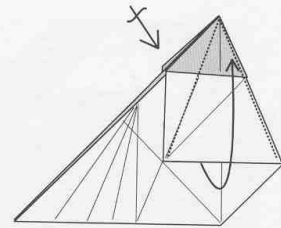

23. Sacar una aleta de atrás hacia adelante. Repetir atrás.
Pull out a flap from underneath and bring it in front. Repeat behind

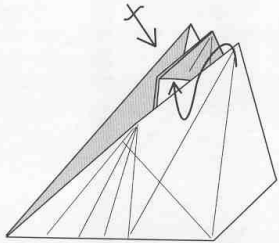

24. Meter la aleta blanca debajo de la capucha de color. Repetir atrás.
Tuck the white flap under the colored cap. Repeat behind.

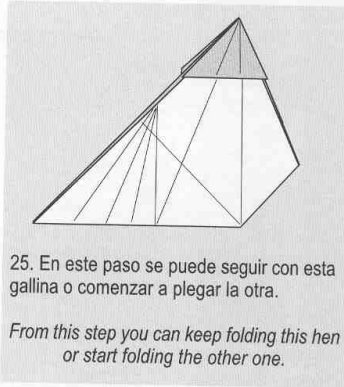

25. En este paso se puede seguir con esta gallina o comenzar a plegar la otra.
From this step you can keep folding this hen or start folding the other one.

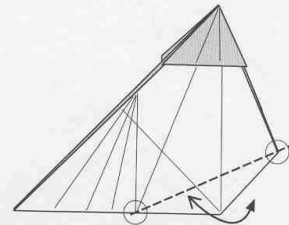

26. Marcar hacia un lado y otro a través de todas las capas.
Crease back and forth through all layers.

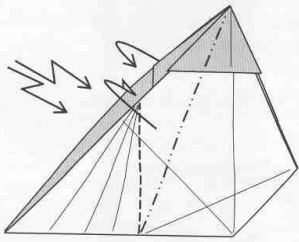

27. Escalonar todas las capas hacia adentro.
Crimp-fold all layers inside the model.

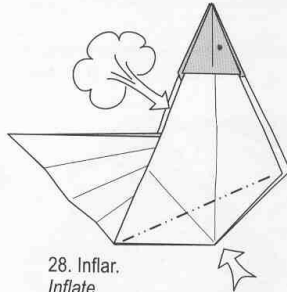

28. Inflar.
Inflate.

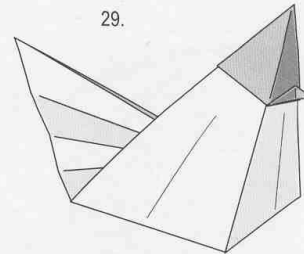

29.

**Para plegar la segunda gallina geométrica comenzar con el paso 25 de la anterior.
To fold the second geometric hen, start with step 25 of the previous one.**

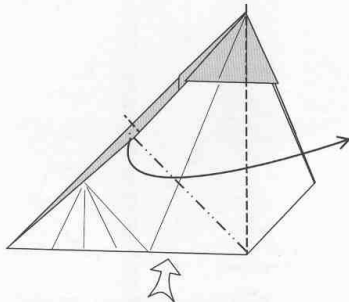

26. Abrir y aplastar.
Squash-fold.

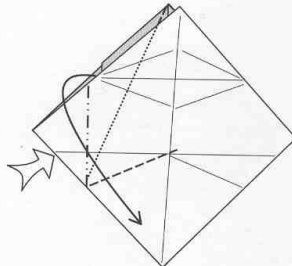

27. Abrir pero sólo aplastar en la mitad izquierda.
Squash-fold but only flatten the left half.

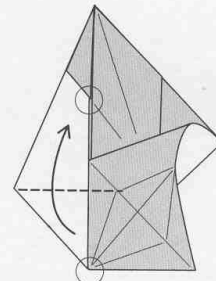

28. Doblar en valle, nuevamente, sólo marcar la mitad izquierda.
Valley-fold and only crease the left half.



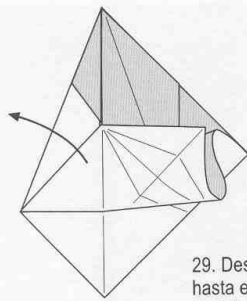

29. Desdoblar hasta el paso 27.
Unfold to step 27.

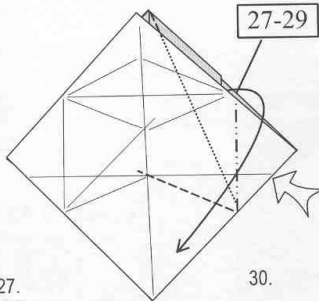

30.

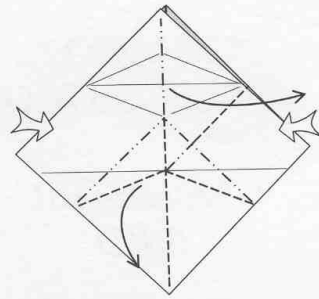

31. Empujar de ambos lados formando una punta.
Push on both sides to form a point.

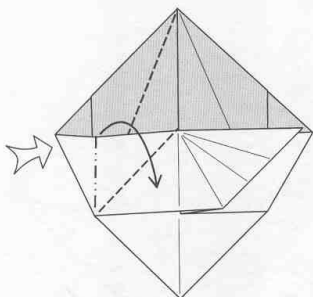

32. Abrir y aplastar.
Squash-fold.

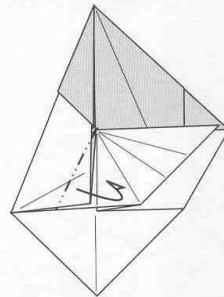

33. Doblar en monte trabando.
Lock with a mountain-fold.

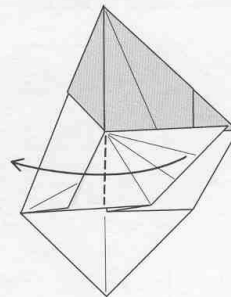

34. Doblar en valle.
Valley-fold.

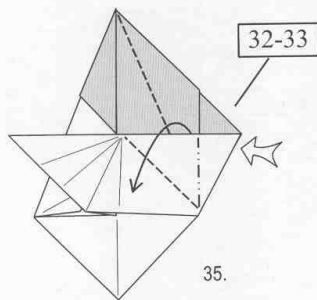

35.

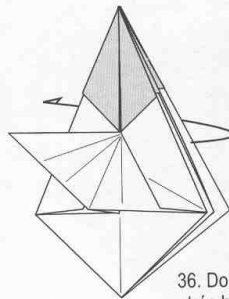

36. Doblar un borde de atrás hacia la izquierda.
Swing one of the far edges to the left.

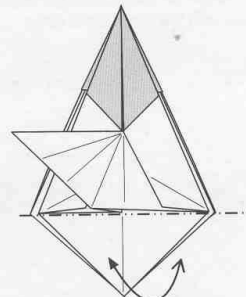

37. Marcar hacia un lado y otro a través de todas las capas.
Crease back and forth through all layers.

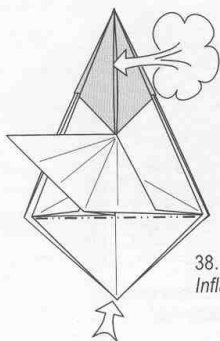

38. Inflar.
Inflate.

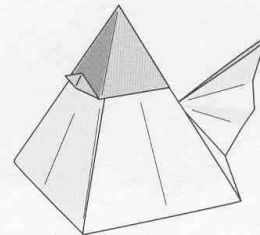
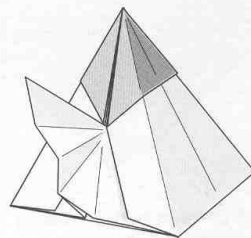

PAJARO POLIEDRICO

GEOMETRIC BIRD

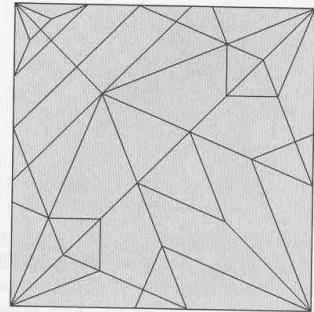
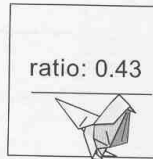
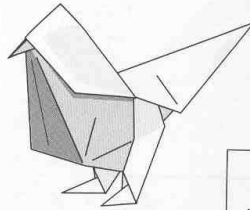

Nivel 2
Papel favorito: Kami de dos colores.
Tamaño recomendado: 15 a 20 cm.
Comentarios: doblar en seco.

Level 2
Favorite paper: Duocolor kami.
Recommended size: 15 to 20 cm.
Comments: dry-fold.

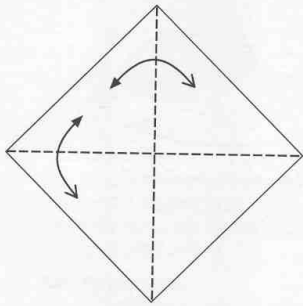

1. Comenzar con el color del pecho hacia abajo.
Start with the chest color down.

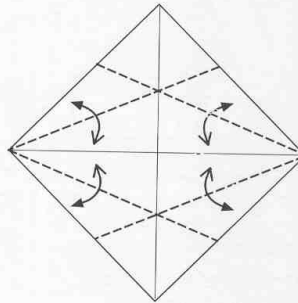

2.

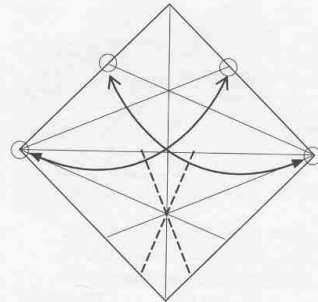

3.

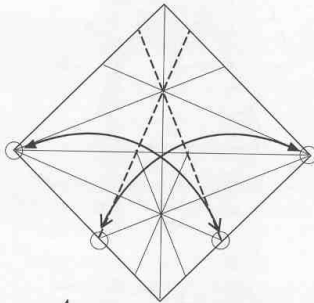

4.

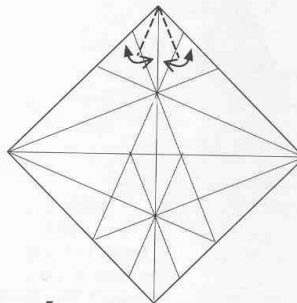

5.

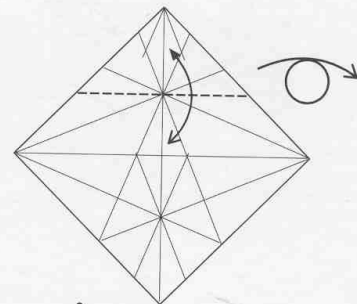

6.

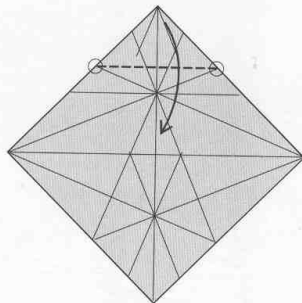

7. Doblar en valle.
Valley-fold.

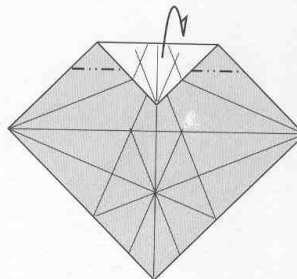

8. Doblar en monte permitiendo que la punta rote.
Mountain-fold, allowing the point to swing up.

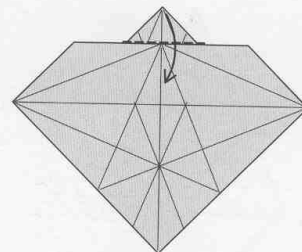

9. Doblar en valle.
Valley-fold.



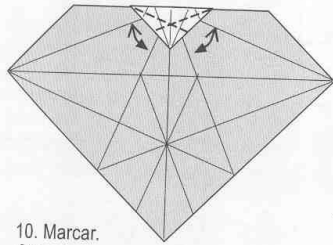

10. Marcar.
Crease.

11. Formar una
punta.
Make a point.

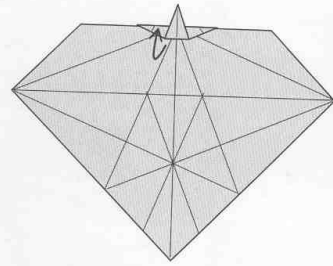
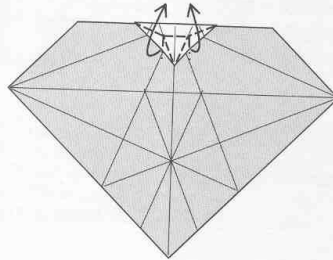

12. Pasar una capa hacia adelante.
Bring one layer to the front.

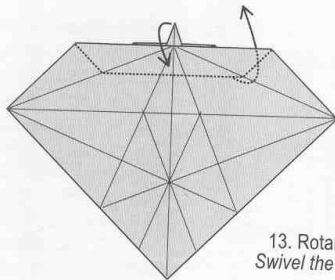

13. Rotar el conjunto.
Swivel the whole flap up.

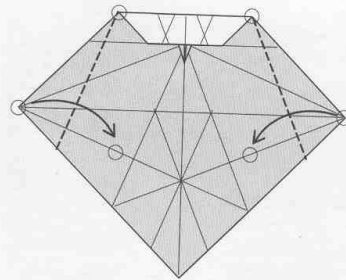

14. Doblar en valle.
Valley-fold.

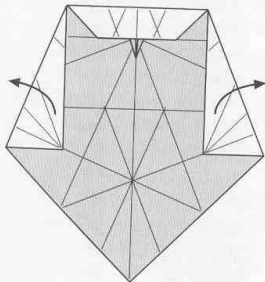

15. Desdoblar.
Unfold.

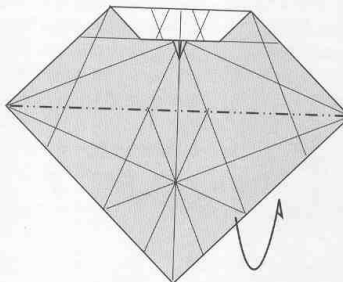

16. Doblar en monte.
Mountain-fold.

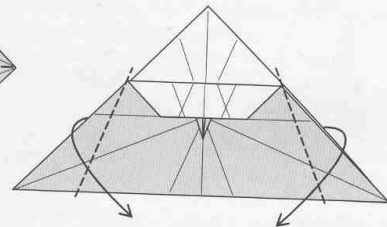

17. Doblar dos capas juntas en valle.
Valley-fold two layers as one.

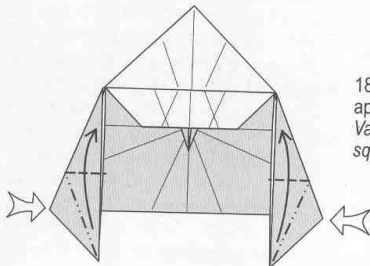

18. Doblar las puntas
aplastando la esquina.
Valley-fold the points
squashing the corners.

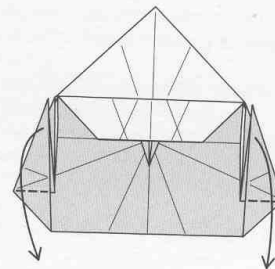

19. Doblar en valle.
Valley-fold.



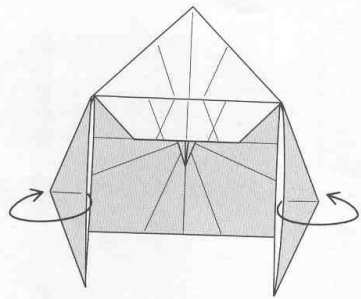

20. Envolver una capa alrededor cambiando el color.
Wrap one layer around, changing the color.

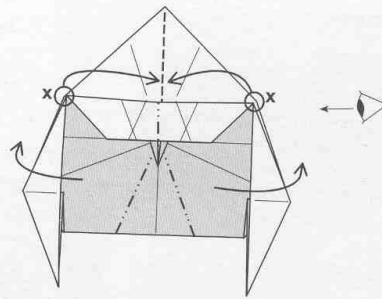

21. Juntar las 4 esquinas "x" en el centro.
 Se debe formar un poliedro en el cuerpo del ave.
Bring the 4 "x" corners together. A polyhedron will be formed to make the bird's body.

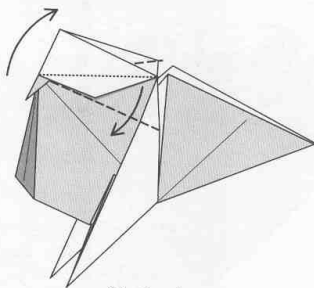

22. Escalonar.
Crimp-fold.

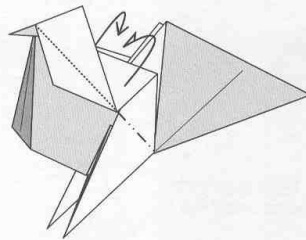

23. Doblar en monte dentro del cuerpo.
Mountain-fold inside the body.

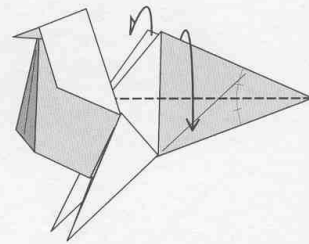

24. Doblar en valle bisectando la cola.
Valley-fold, bisecting the tail.

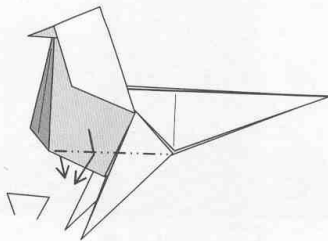

25. Angular los muslos siguiendo el borde del poliedro.
Angle the thighs following the edge of the polyhedron.

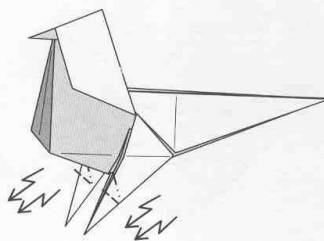

26. Escalonar.
Crimp-fold.

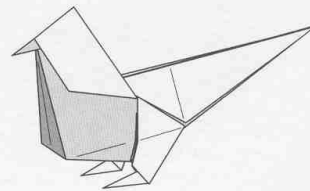

27.

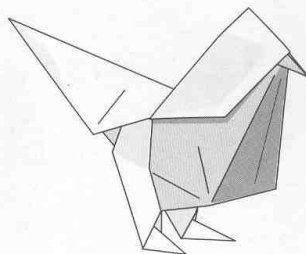

T-REX

Un diseño de Joseph Wu y Román Díaz, basado en el pájaro poliédrico de la página 66.

A design by Joseph Wu and Román Díaz, based on the geometric bird on page 66.

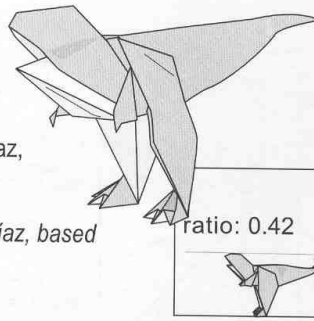

ratio: 0.42

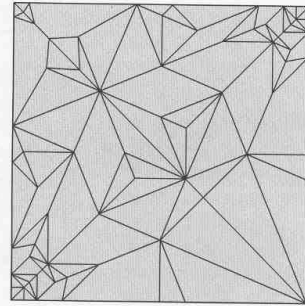

Nivel 3

Papel favorito: Kami bicolor, metalizado grueso.

Tamaño recomendado: 24 cm.

Comentarios: doblar en seco.

Level 3

Favorite paper: Duocolor kami, thick color foil.

Recommended size: 24 cm.

Comments: dry-fold.

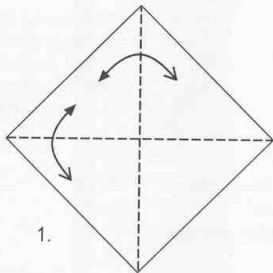

1.

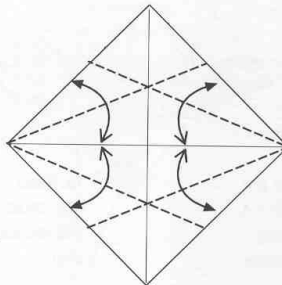

2.

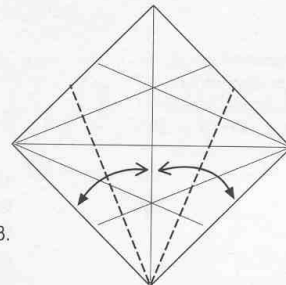

3.

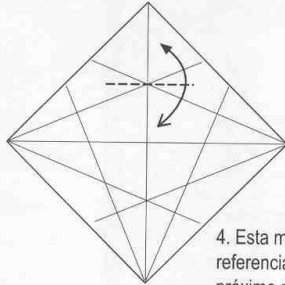

4. Esta marca será referencia para el próximo paso.
This crease will be the reference for the next step.

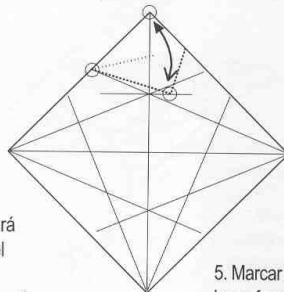

5. Marcar observando bien las referencias.
Crease, observing the references carefully.

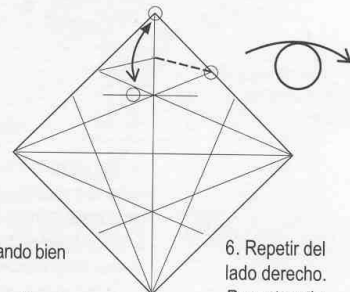

6. Repetir del lado derecho.
Repeat on the right side.

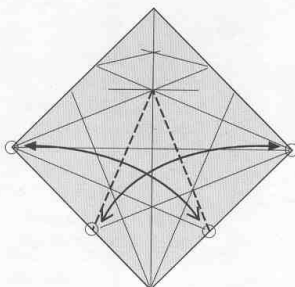

7. Marcar.
Crease.

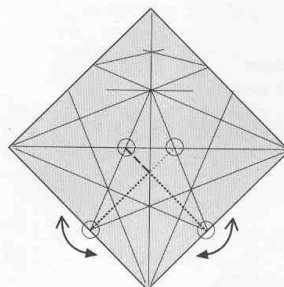

8. Marcar solo la zona que se muestra.
Only crease where shown.

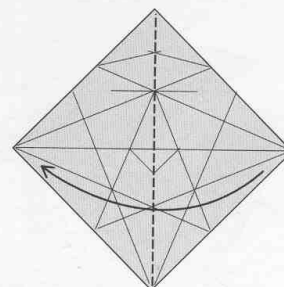

9. Doblar al medio.
Fold in half.



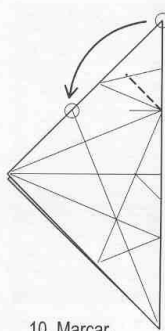

10. Marcar.
Crease.

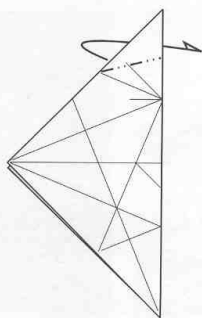

11. Doblar las dos capas juntas.
Fold both layers as one.

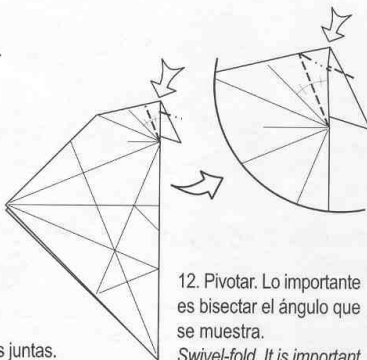

12. Pivotar. Lo importante es bisectar el ángulo que se muestra.
Swivel-fold. It is important to bisect the angle shown.

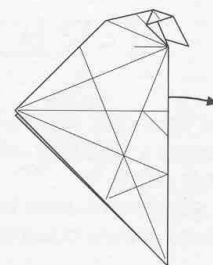

13. Desdoblar todo, lado blanco hacia arriba.
Unfold everything, white side up.

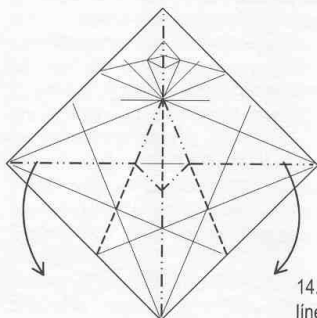

14. Colapsar por líneas existentes.
Collapse using existing creases.

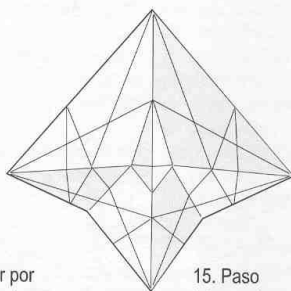

15. Paso intermedio.
Intermediate step.

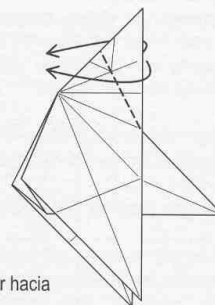

16. Revertir hacia afuera.
Outside reverse-fold.

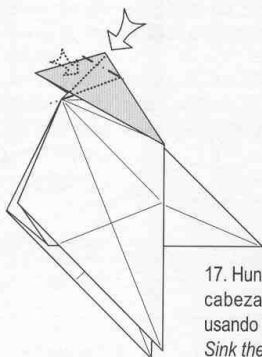

17. Hundir al mismo tiempo la cabeza y adentro de la boca usando las marcas del paso 12.
Sink the head and the inside of the mouth at the same time, using the creases from step 12.

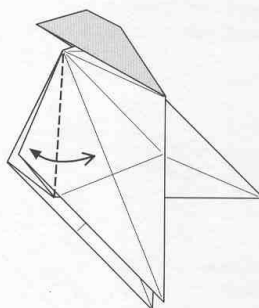

18. Marcar para referencia.
Crease as a reference.

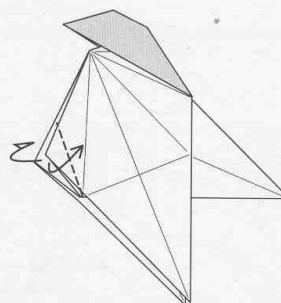

19. Doblar una esquina hacia cada lado.
Fold one corner to each side.

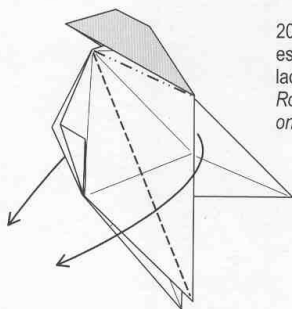

20. Rotar la cabeza escalonando de ambos lados.
Rotate the head, pleating on both sides.

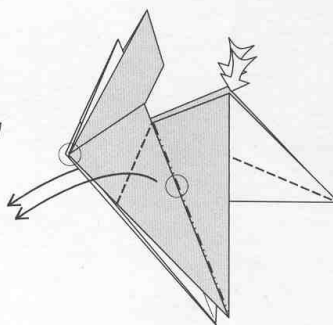

21. Doblar las aletas largas aplastando las esquinas. El borde debe tocar la punta como se muestra.
Fold the two long flaps while squashing two corners. The edge must touch the point as shown.



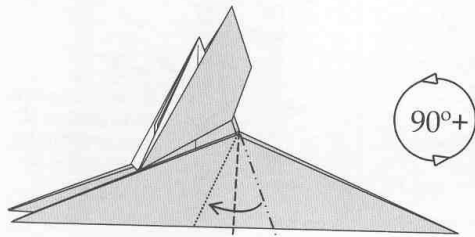

22. Escalonar todas las capas juntas.
Usar un borde oculto como referencia.
Pleat all layers together. Use a hidden edge as a reference.

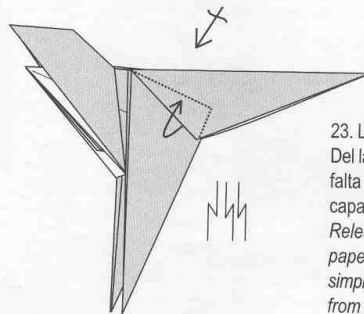

23. Liberar papel atrapado.
Del lado de atrás sólo hace falta desenganchar una capa de la capa central.
Release some trapped paper. On the other side simply disengage one layer from the middle layer.

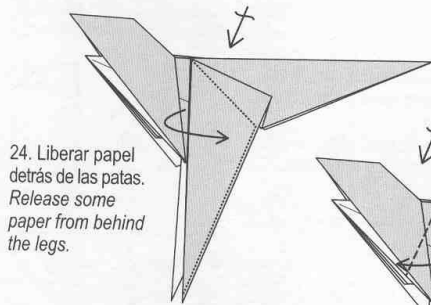

24. Liberar papel detrás de las patas.
Release some paper from behind the legs.

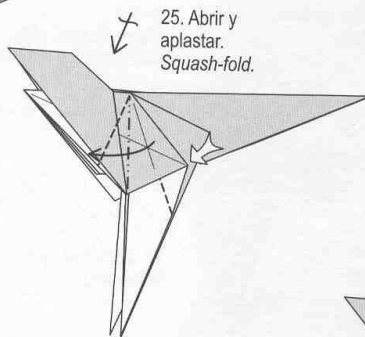

25. Abrir y aplastar.
Squash-fold.

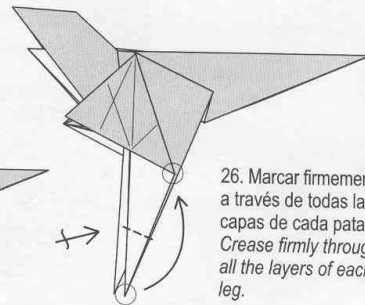

26. Marcar firmemente a través de todas las capas de cada pata.
Crease firmly through all the layers of each leg.



27. Marcar a través de todas las capas de cada pata.
Crease through all the layers of each leg.

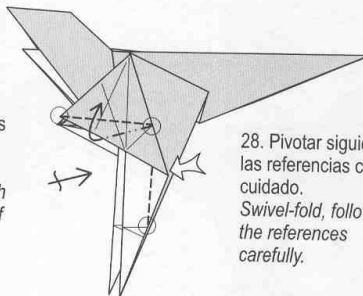

28. Pivotar siguiendo las referencias con cuidado.
Swivel-fold, following the references carefully.

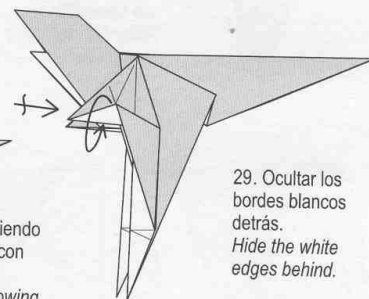

29. Ocultar los bordes blancos detrás.
Hide the white edges behind.

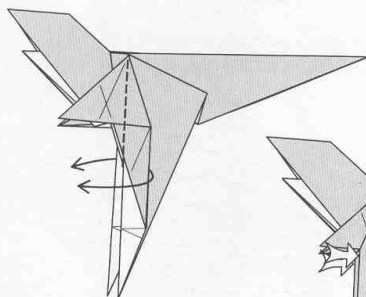

30. Doblar en valle un borde de cada lado.
Valley fold an edge on each side.

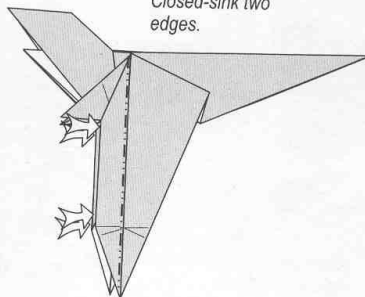

31. Hundir cerrado en dos bordes.
Closed-sink two edges.

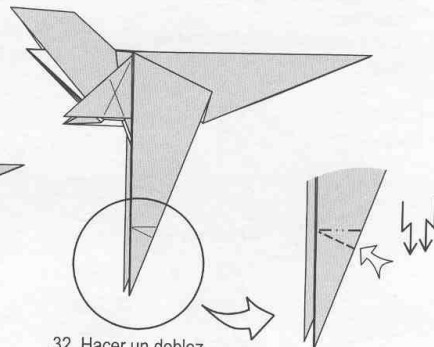

32. Hacer un doblez escalonado simétrico.
Make a crimp.



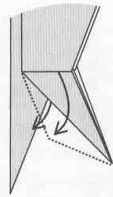

33. Sacar el papel atrapado.
Release the top layer of trapped paper on both sides.

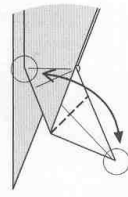

34. Marcar.
Crease.

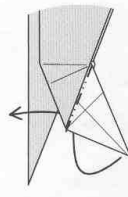

35. Revertir.
Reverse-fold.

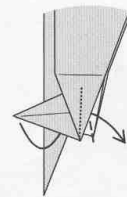

36. Revertir sobre la marca del paso 34.
Reverse-fold on the crease of step 34.

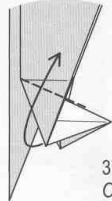

37. Abrir.
Open.

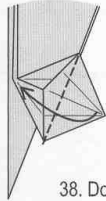

38. Doblar en valle.
Valley-fold.

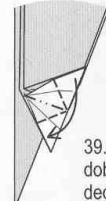

39. Cerrar incorporando los dobleces que forman los tres dedos.
Close, incorporating the folds that make the three toes.

32-39

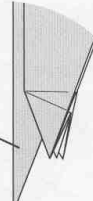

40.

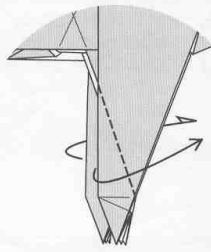

41. Doblar en valle siguiendo un borde que hay detrás.
Valley-fold, following an edge behind.

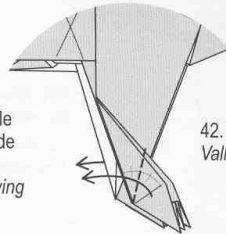

42. Doblar en valle.
Valley-fold.

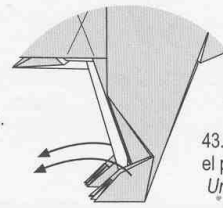

43. Desdoblar hasta el paso 41.
Unfold to step 41.

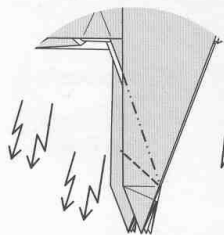

44. Escalonar usando los dobleces anteriores.
Crimp using folds from the previous steps.

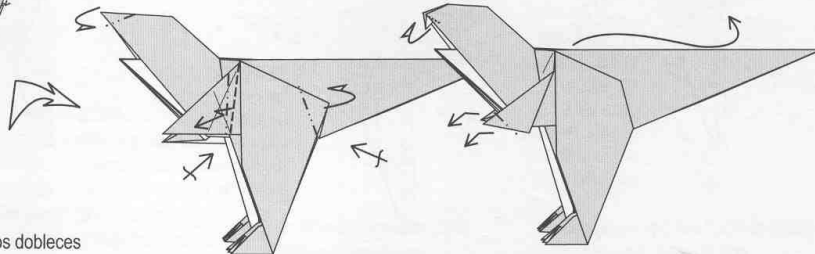

45 - 46. Terminar las manos. Trabrar los muslos y el hocico, ondular la cola.
Crimp the arms and finish the hands. Lock the thighs and nose, and curve the tail.

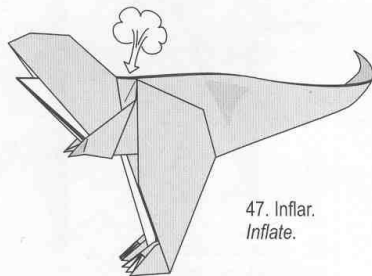

47. Inflar.
Inflate.

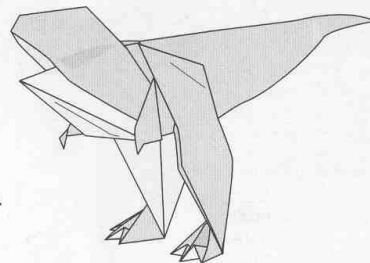

48.



CISNE

SWAN

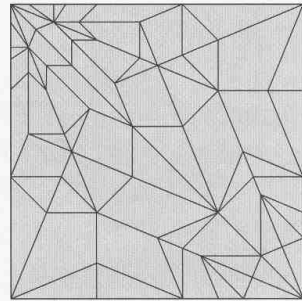
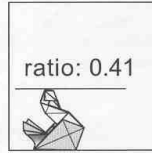
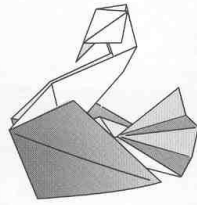

Nivel 2
 Papel favorito: Kami bicolor o decorado.
 Tamaño recomendado: 15 a 20 cm.
 Comentarios: doblar en seco.

Level 2
 Favorite paper: Duocolor or patterned Kami.
 Recommended size: 15 to 20 cm.
 Comments: dry-fold.

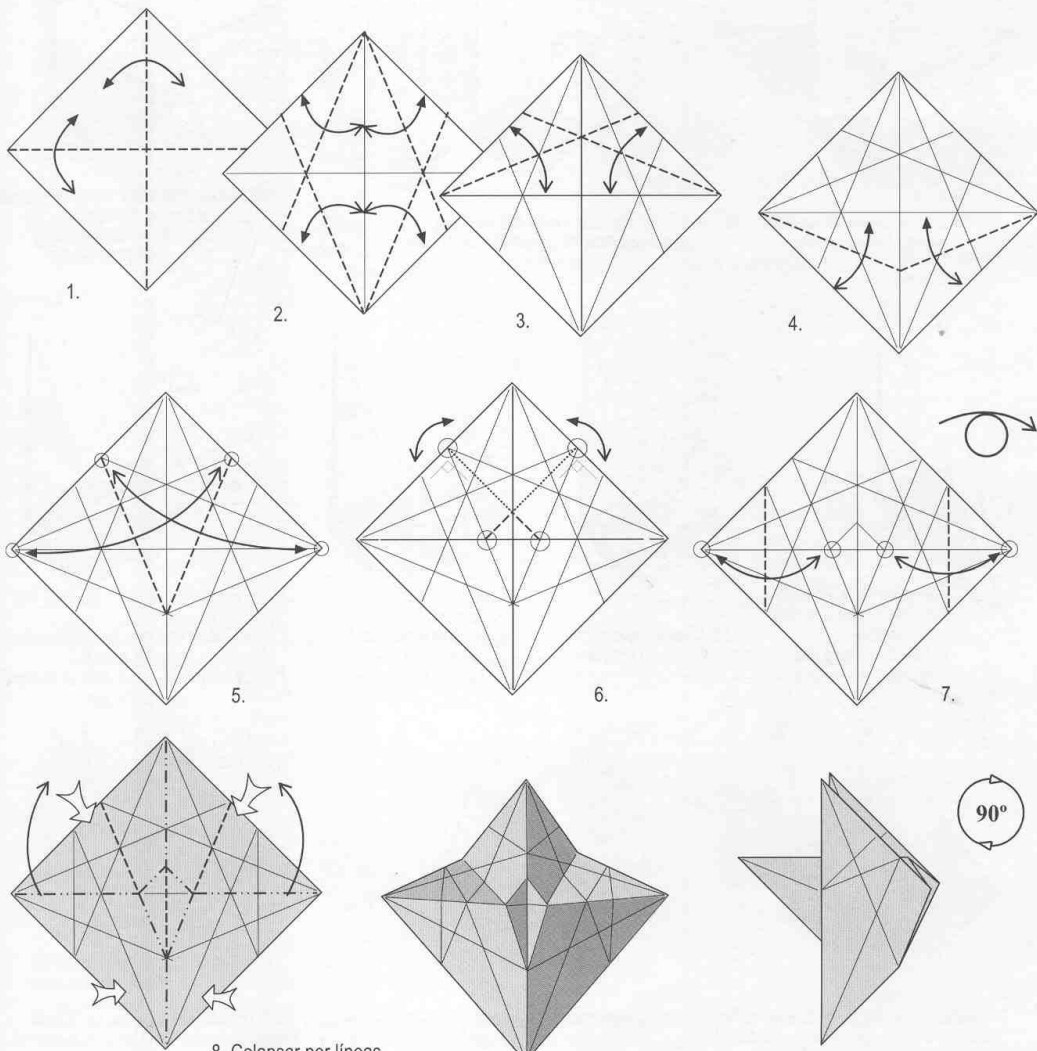

8. Colapsar por líneas existentes.
 Collapse using existing creases.

9. Paso intermedio.
 Intermediate step.

10. Rotar 90°.
 Rotate 90°.



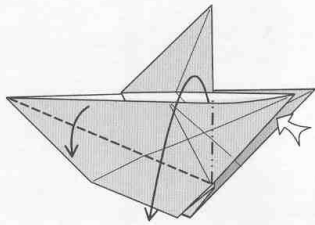

11. Abrir y aplastar no simétricamente.
Squash-fold asymmetrically.

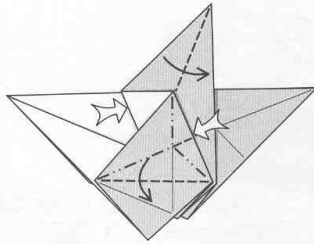

12. Cambiar el color de la parte superior mientras se colapsa la parte inferior.
Color-change the top part while collapsing the bottom part.

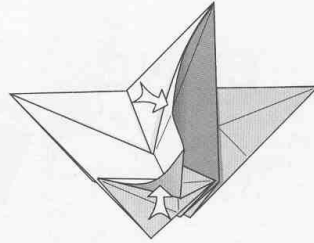

13. Paso intermedio.
Intermediate step.

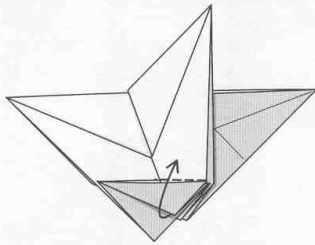

14. Doblar un borde en valle.
Valley-fold one edge.

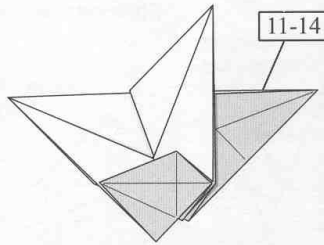

15. Repetir 11-14 del otro lado.
Repeat steps 11-14 on the other side.

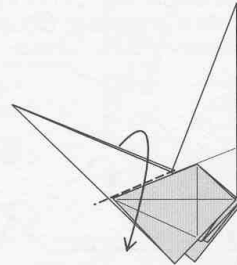

16. Doblar todas las capas siguiendo el borde del cuerpo.
Valley-fold all layers along the edge of the body.

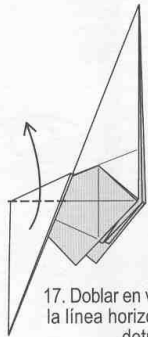

17. Doblar en valle siguiendo la línea horizontal que hay detrás.
Valley-fold along the horizontal line behind.

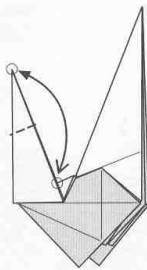

18. Doblar y desdoblar.
Fold and unfold.

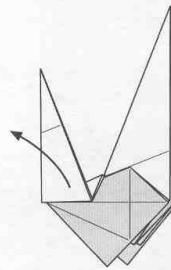

19. Desdoblar hasta el paso 16.
Unfold to step 16.

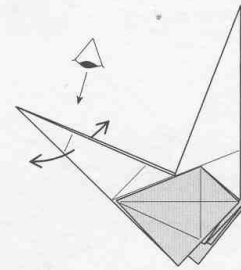

20. Abrir un poco las capas y ver desde arriba.
Open the layers a little and view from the top.

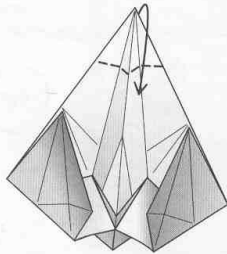

21. Doblar la punta de la cola en valle usando sólo la marca del paso 18.
Valley fold the tip of the tail using only the crease lines from step 18.

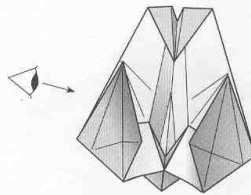

22. Cerrar todas las capas nuevamente y volver a la vista lateral.
Fold everything flat again and go back to a side view.

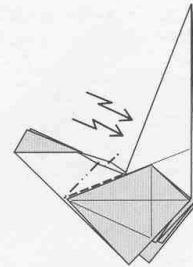

23. Escalonar la base de la cola simétricamente hacia ambos lados del cuerpo.
Crimp-fold the base of the tail to the outside of the body.



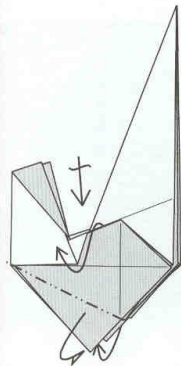

24. Pasar una capa de color hacia adelante. Afinar el cuerpo doblando papel hacia adentro. Bring the colored layer to the front. Shape the body, folding back some paper.

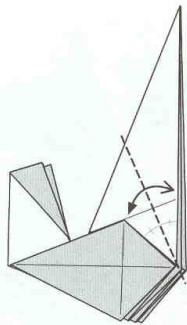

25. Doblar y desdoblar la bisectriz a través de todas las capas. Fold and unfold the angle bisector through all layers.

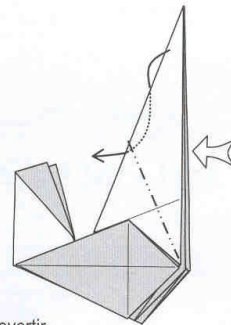

26. Revertir. Reverse fold.

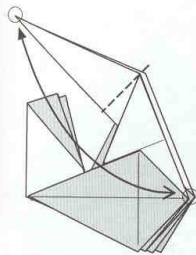

27. Doblar y desdoblar. Fold and unfold.

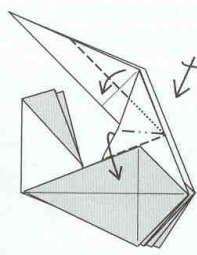

28. Hacer un doblez pivotado. Repetir atrás. Swivel-fold. Repeat behind.

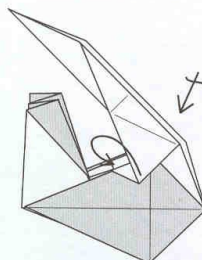

29. Introducir la aleta dentro del cuerpo. Repetir atrás. Tuck this flap into the body. Repeat behind.

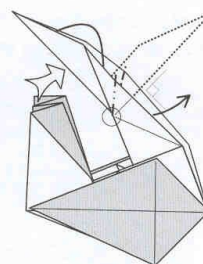

30. Revertir. Reverse fold.

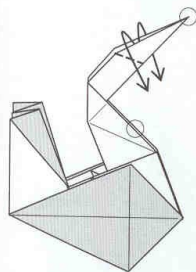

31. Revertir hacia afuera. La punta del pico apenas toca el cuello. Outside reverse fold. The tip of the beak only just touches the neck.

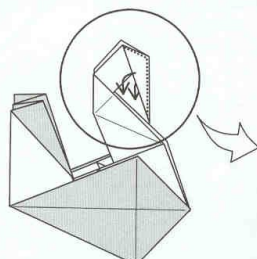

32. Sacar papel de adentro de la cabeza. Pull out some paper from inside the head.

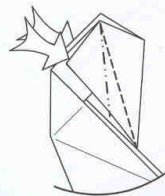

33. Hacer un pequeño doblez escalonado formando el cambio de color en el pico. Make a thin pleat to change the color of the beak.

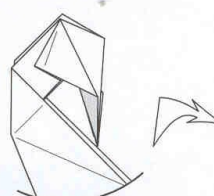

34. Abrir la cola en abanico invirtiendo los pliegues. Fan out the tail, changing the direction of the creases.

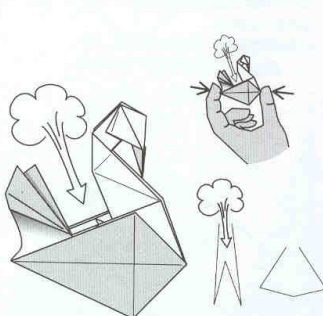

35. Apartar el cuello hacia un lado para inflar el modelo soplando por el lomo. Para facilitar el inflado se debe apretar suavemente como se muestra. Push the neck aside to blow air into the model and inflate it. Gently pressing as shown will make the model puff up more easily.

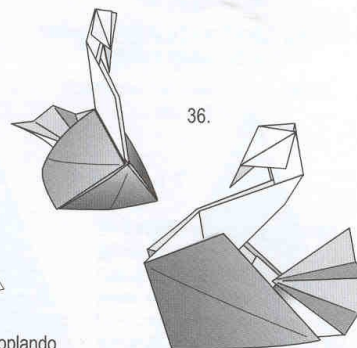

36.



PALOMA ENAMORADA

DOVE IN LOVE

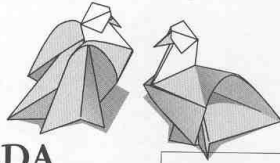

ratio:0.47

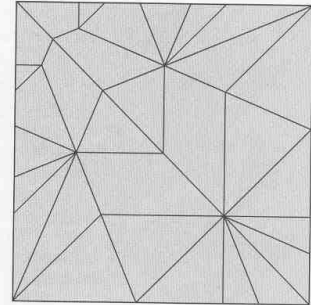

Nivel 2

Papel favorito: Kami de dos colores, "tant" u otro papel firme.

Tamaño recomendado: 15 cm

Comentarios: doblar en seco.

Level 2

Favorite paper: two color Kami, "tant" or any firm paper.

Tamaño recomendado: 15 cm.

Comments: dry-fold.

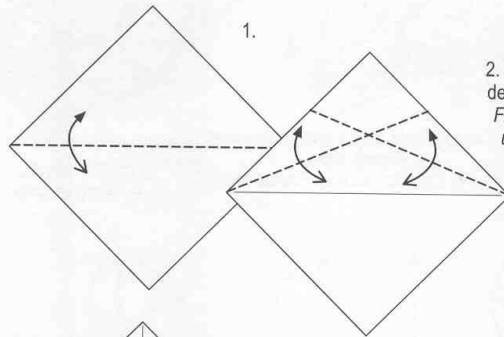

1.

2. Doblar y desdoblar.
Fold and unfold.

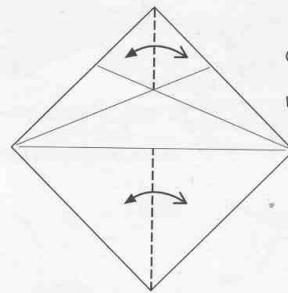

3. Doblar y desdoblar sólo donde se indica.
Crease only where indicated.

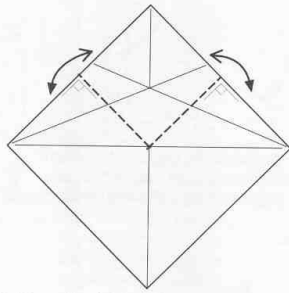

4. Doblar y desdoblar sólo donde se indica.
Crease only where indicated.

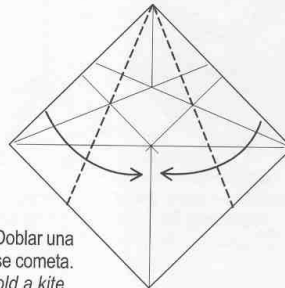

5. Doblar una base cometa.
Fold a kite base.

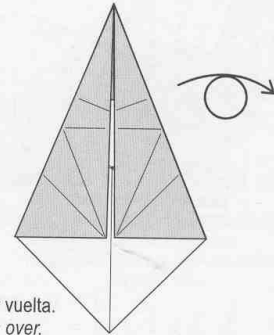

6. Dar vuelta.
Turn over.

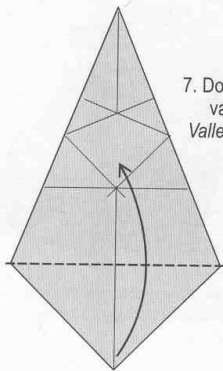

7. Doblar en valle.
Valley fold.

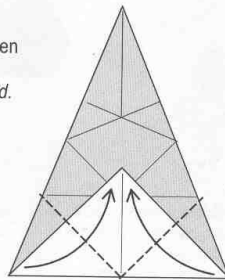

8. Doblar en valle.
Valley fold.

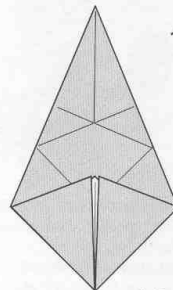

9. Dar vuelta.
Turn over.

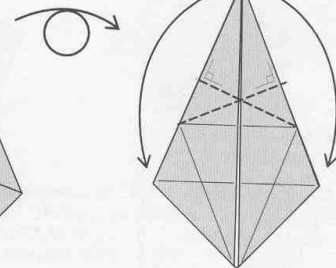

10. Doblar y desdoblar.
Fold and unfold.



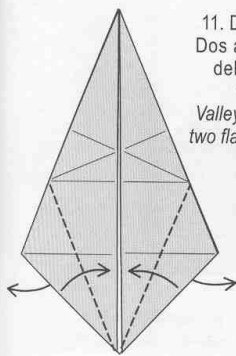

11. Doblar en valle.
Dos aletas de atrás
deben rotar sin
doblarse.
*Valley-fold. Allow the
two flaps behind to flip
forwards.*

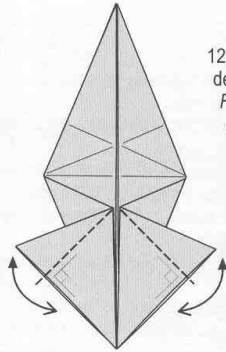

12. Doblar y
desdoblar.
*Fold and
unfold.*

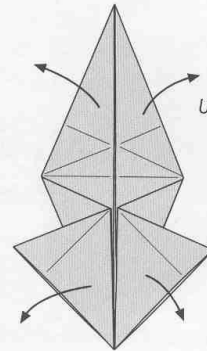

13. Desdoblar
totalmente.
Unfold completely.

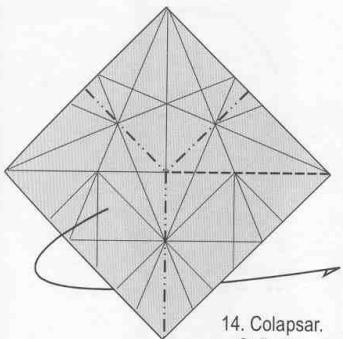

14. Colapsar.
Collapse.

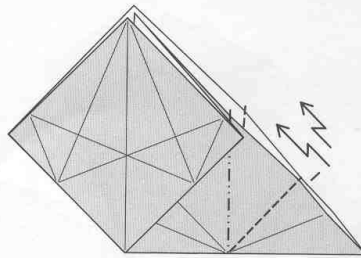

15. Escalonar.
Crimp.

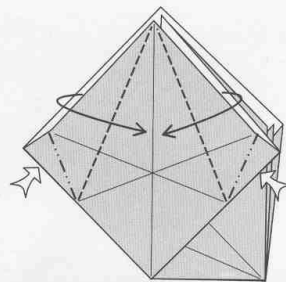

16. Doblar en valle
aplastando las esquinas.
*Valley-fold while
squash-folding the
corners.*

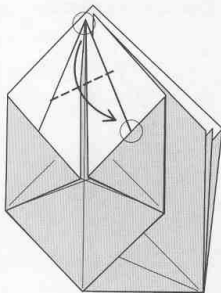

17. Doblar la punta a la referencia.
Fold the tip to the reference point.

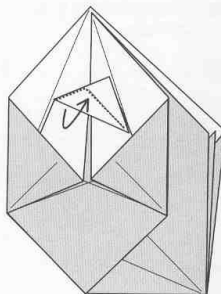

18. Sacar papel
atrapado.
*Pull out the
trapped paper.*

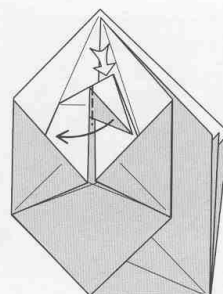

19. Doblar hacia un lado mientras
se aplasta la esquina.
*Fold to one side while
squash-folding
the corner.*

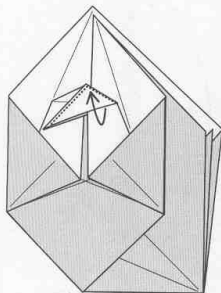

20. Sacar papel
atrapado.
*Pull out the
trapped paper.*

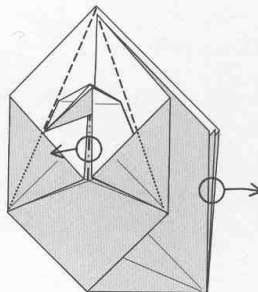

21. Tirar del cuello separándolo
de las alas.
Con la otra mano tirar hacia atrás
desde la cola. El modelo debe
tomar volumen de ahora en
adelante.
*Pull the neck away from the
wings. At the same time pull the
tail out. The model will not lie flat
after this step.*



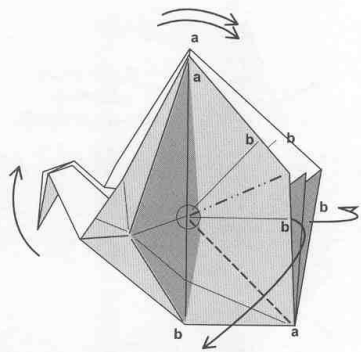

22. Abrir las capas de la derecha, una hacia cada lado.
 El conjunto pivota alrededor del punto marcado.
 Todos los puntos "b" se juntarán en un mismo lugar y todos los "a" en otro.
Open the layers on the right, one layer to each side.
Everything will pivot around the marked circle.
All the points marked "a" will come together, as will the points marked "b".

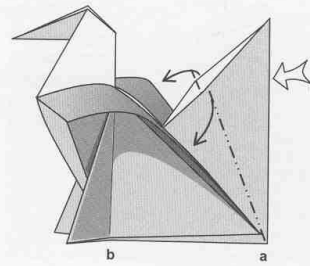

23. Aplastar la cola.
Squash-fold the tail.

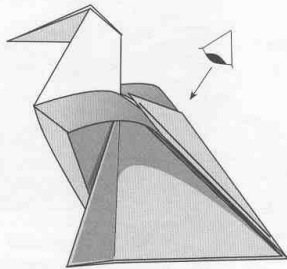

24. Mirar desde arriba.
View from above.

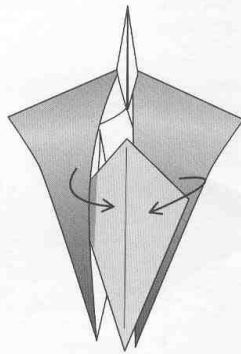

25. Encajar las capas de la cola dentro de las alas.
Tuck the tail layers into the wing pockets.

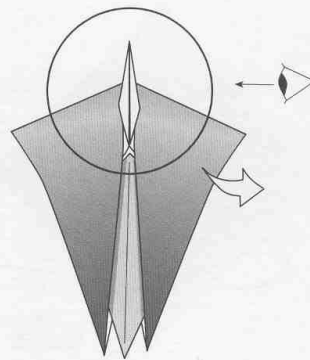

26. Vista lateral de la cabeza.
Side view of the head.

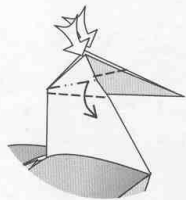

27. Aplastar formando la cabeza y el pico.
Squash-fold, forming the head and beak.

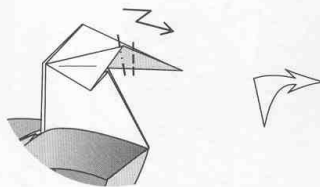

28. Escalonar el pico.
Crimp-fold the beak.

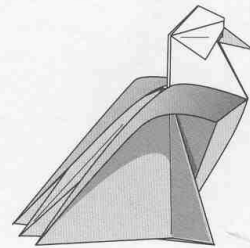

29.

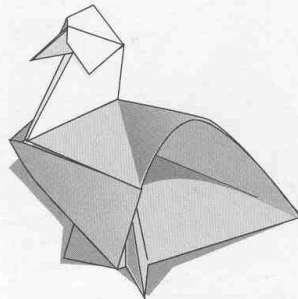
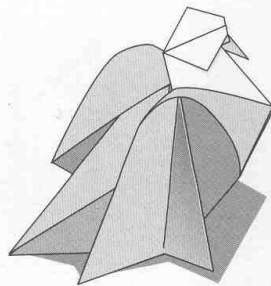

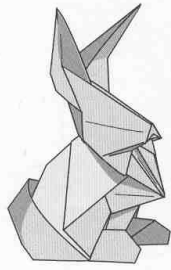

CONEJO

BUNNY

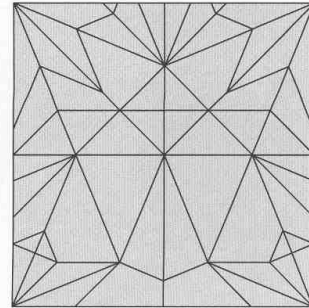
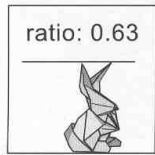

Nivel 2
 Papel favorito: Espesor medio, mismo color en ambas caras
 Tamaño recomendado: 20 cm.
 Comentarios: doblar en seco.

Level 2
 Favorite paper: medium thickness, same color on both sides.
 Recommended size: 20 cm.
 Comments: dry-fold.

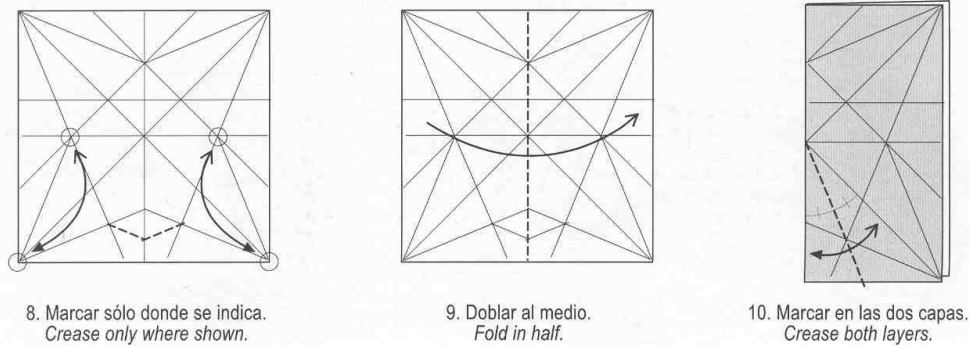
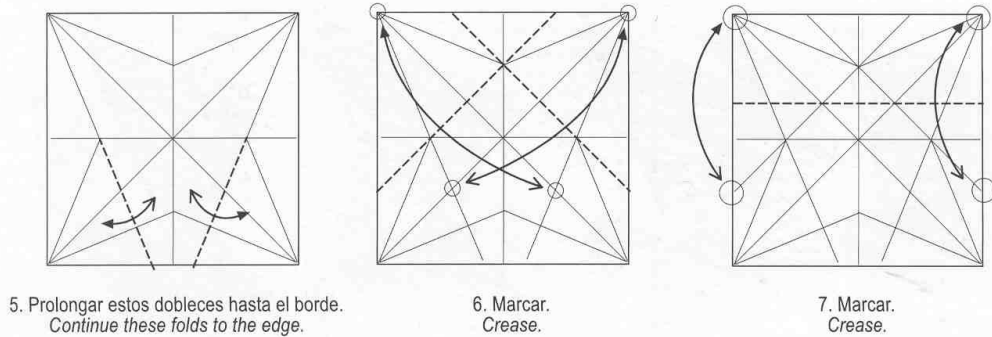
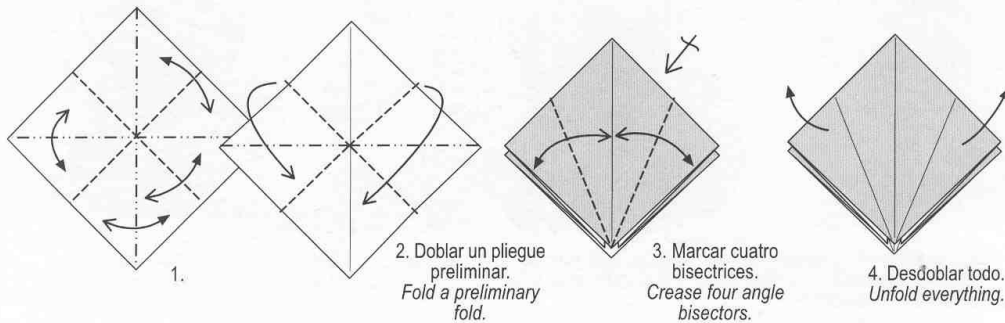

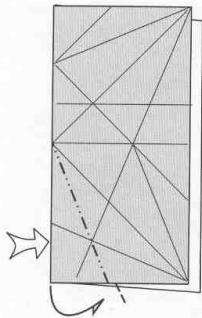

11. Revertir.
Reverse-fold.

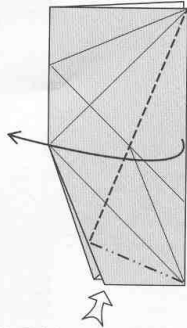

12. Doblar en valle aplastando una esquina. No aplanar totalmente aun.
Valley-fold while squashing a corner. Do not flatten yet.

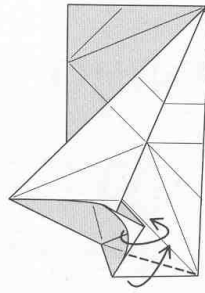

13. Envolver este acodo.
Wrap the gusset around.

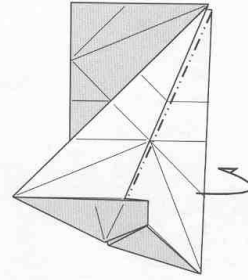

14. Doblar en monte.
Mountain-fold.

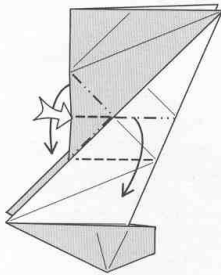

15. Hundir un borde mientras se escalona a los lados.
Push an edge in, while crimp-folding the sides.

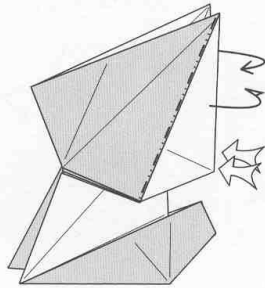

16. Revertir.
Reverse-fold.

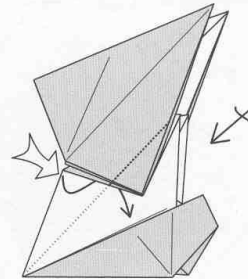

17. Revertir.
Reverse-fold.

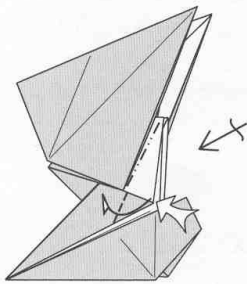

18. Revertir.
Reverse-fold.

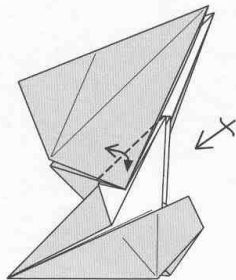

19. Marcar.
Crease.

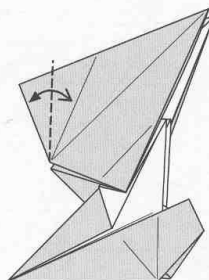

20. Marcar.
Crease.

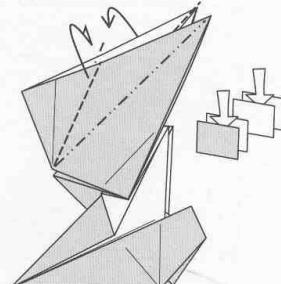

21. Hacer un doblez escalonado entre las capas.
Crimp-fold in between the layers.

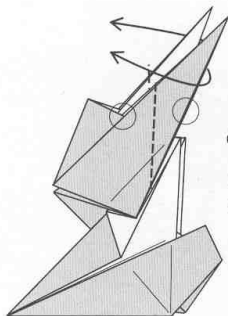

22. Notar que el doblez es paralelo al borde blanco.
Note how the fold is parallel to the white edge.

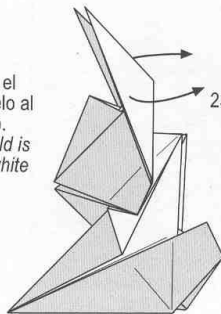

23. Desdoblar.
Unfold.

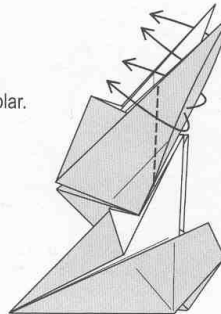

24. Revertir las orejas hacia afuera.
Outside reverse-fold the ears.



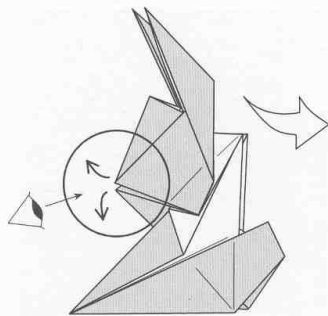

25. Separar las puntas para ver la nariz de frente.
Pull the points apart and look at the tip of the nose.

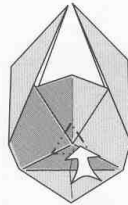

26. Hundir cerrado.
Closed-sink.

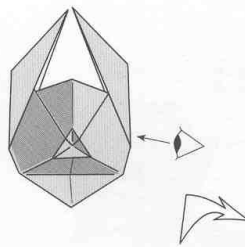

27. Introducir las dos capas en un bolsillo.
Tuck the two layers into a pocket.

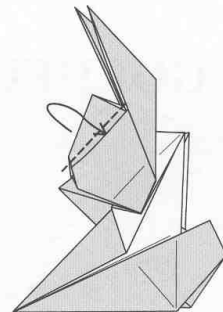

28. Revertir.
Reverse-fold.

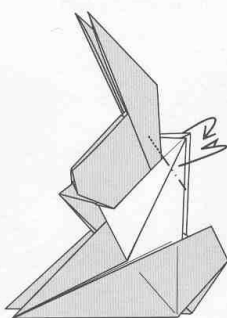

29. Doblar en monte.
Mountain-fold.

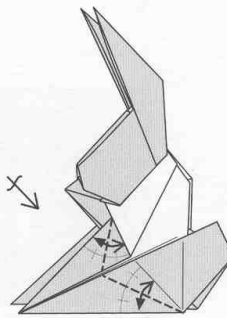

30. Marcar.
Crease.

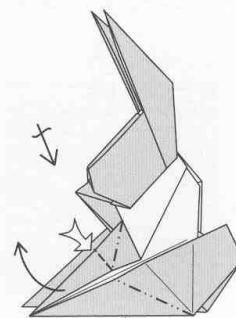

31. Doble oreja de conejo.
Double rabbit-ear.

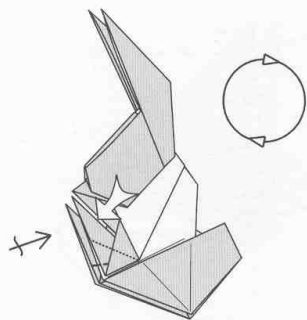

32. Aplastar asimétricamente.
Squash-fold asymmetrically.

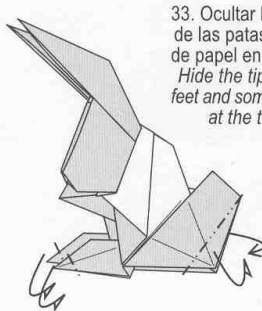

33. Ocultar la punta de las patas y algo de papel en la cola.
Hide the tip of the feet and some paper at the tail.

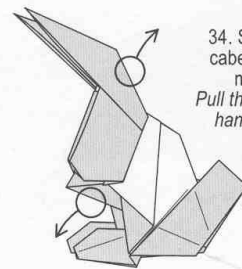

34. Separar la cabeza de las manos.
Pull the head and hands apart.

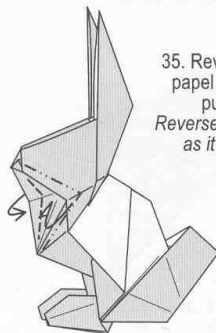

35. Revertir tanto papel como se pueda.
Reverse-fold as far as it will go.

36. Abrir las orejas e inflar.
El lomo quedará totalmente abierto.
Position the ears and inflate. The back will remain completely open.

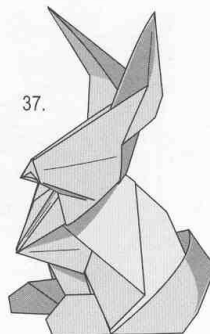
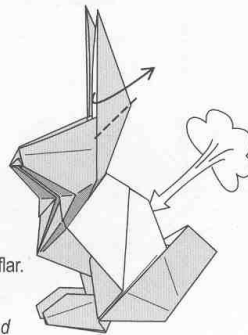

37.



GOLDFISH

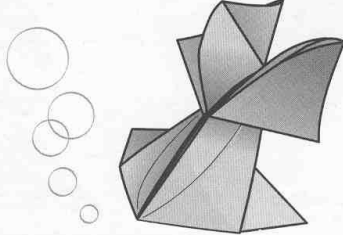

Nivel 1
 Papel favorito: Tant.
 Tamaño recomendado: 15 a 20 cm.
 Comentarios: doblar en seco.

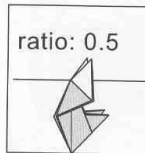

Level 1
 Favorite paper: Tant paper.
 Recommended size: 15 to 20 cm.
 Comments: dry-fold.

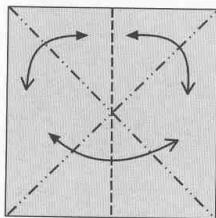
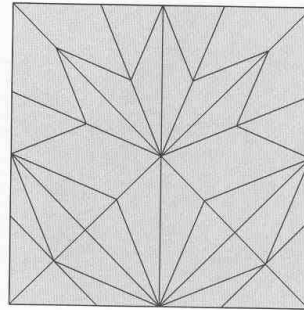

1. Marcar.
 Crease.

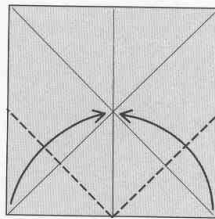

2. Doblar en valle.
 Valley-fold.

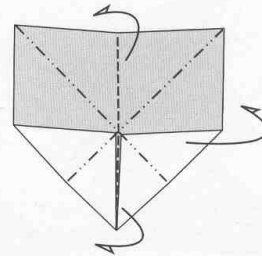

3. Doblar una especie de bomba de agua.
 Collapse like a water bomb base.

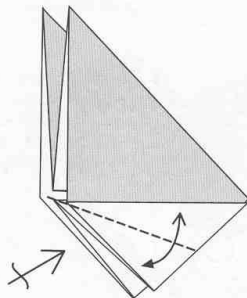

4. Marcar.
 Crease.

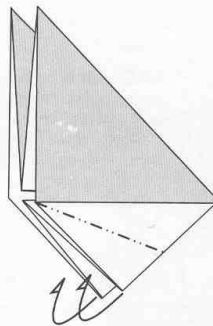

5. Revertir.
 Reverse-fold.

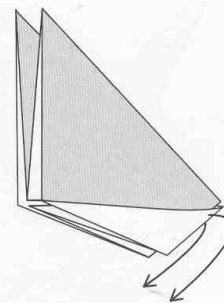

6. Desenvolver las puntas.
 Unwrap the points.

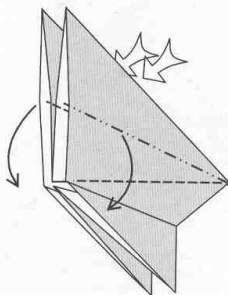

7. Abrir y aplastar.
 Squash-fold.

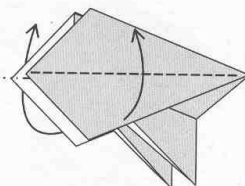

8. Doblar en valle.
 Valley-fold.

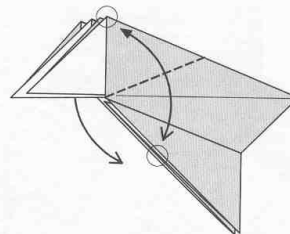

9. Doblar y desdoblar dos capas juntas de cada lado.
 Fold and unfold two layers together on each side.



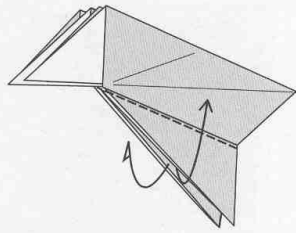

10. Doblar en valle.
Valley-fold.

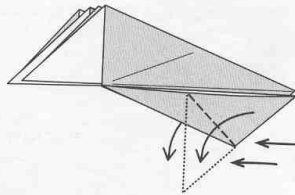

11. Doblar las puntas en valle alineando los bordes.
Valley-fold the fins, aligning the edges.

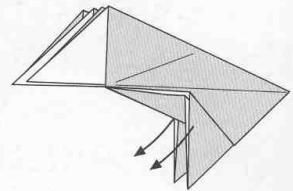

12. Desdoblar al paso 10.
Unfold to step 10.

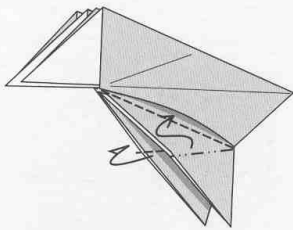

13. Escalonar a la misma posición del paso anterior, pero esta vez meter el papel dentro de los bolsillos.
Crimp-fold just like the previous step, but this time tuck the paper into the pockets.

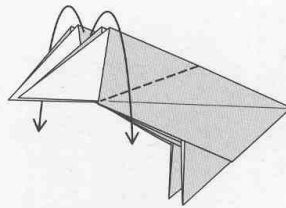

14. Doblar en valle igual que en el paso 9.
Valley-fold as in step 9.

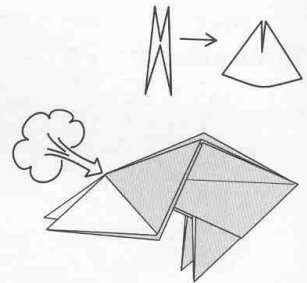

15. Inflar manteniendo el lomo cerrado.
Inflate, holding the edges of the back of the fish together.

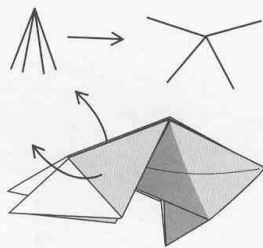

16. Abrir las aletas.
Fan out the tail fins.

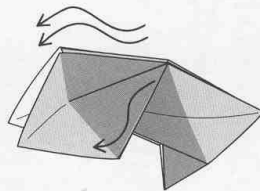

17. Ondular a gusto.
Curve to taste.

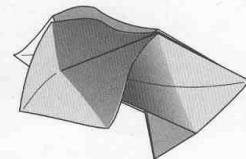

18.

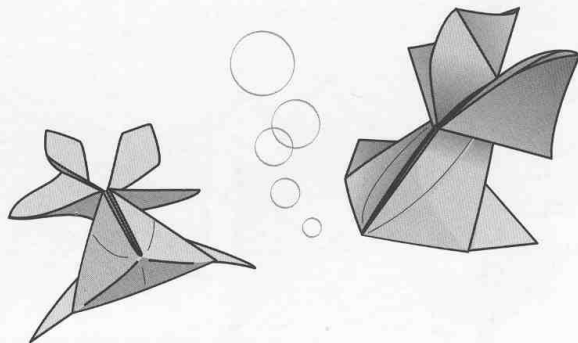

PECES INFLABLES

INFLATABLE FISH

Nivel 2
Papel favorito: Tant, kami bicolor, kami decorado.
Tamaño recomendado: 15 a 20 cm.
Comentarios: doblar en seco.

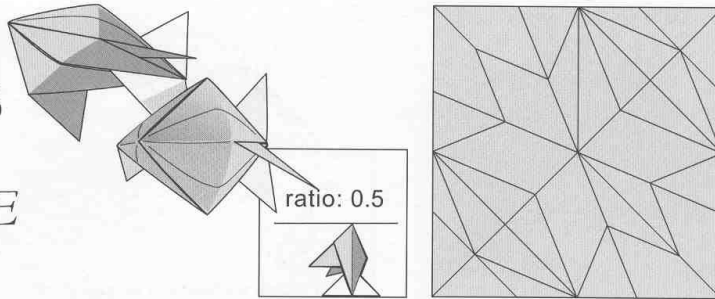

Level 2
Favorite paper: Tant, duocolor or patterned kami.
Recommended size: 15 to 20 cm.
Comments: dry-fold.

PEZ INFLABLE 1 INFLATABLE FISH 1

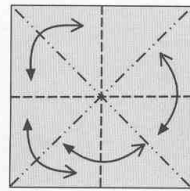

1.

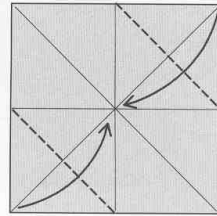

2.

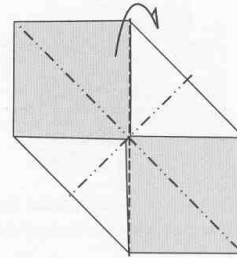

3. Doblar una especie de bomba de agua.
Collapse like a water bomb base.

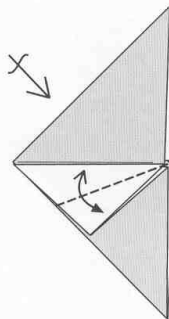

4. Marcar las aletas blancas de ambos lados.
Create the white flaps on both sides.

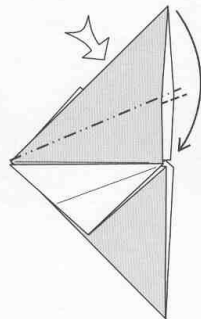

5. Abrir y aplastar.
Squash-fold.

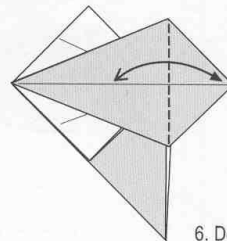

6. Doblar en valle.
Valley-fold.

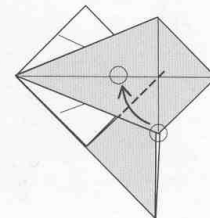

7. Doblar en valle sin aplanar totalmente.
Valley-fold but do not flatten completely.

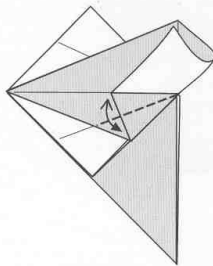

8. Marcar esta esquina.
Crease this corner.

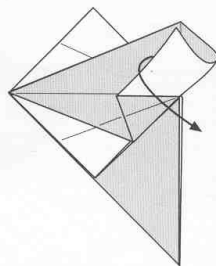

9. Desdoblar.
Unfold.

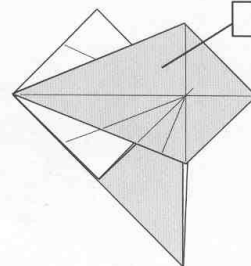

10.

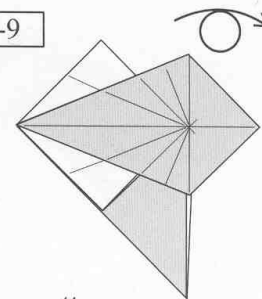

11.



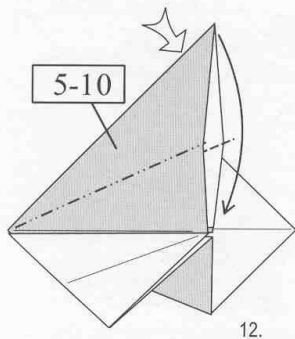

12.

En este paso se puede pasar al paso 1 del segundo pez inflable.
From this step you can skip to step 1 of the second inflatable fish.

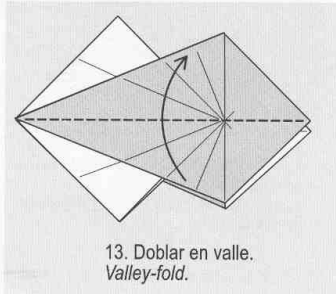

13. Doblar en valle.
Valley-fold.

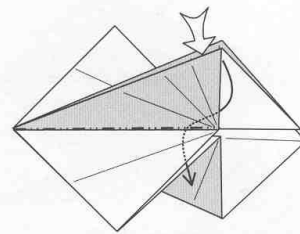

14. Revertir.
Reverse-fold.

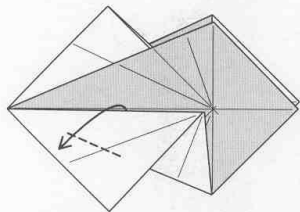

15. Abrir una aleta sin marcar el papel.
Open lower flap without creasing the paper.

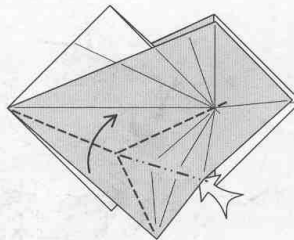

16. Cerrar nuevamente incorporando un doblez revertido. No aplanar aun.
Close again, incorporating this reverse fold. Do not flatten completely yet.

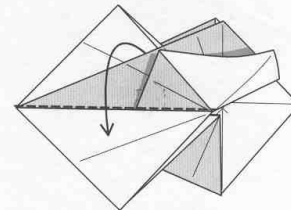

17. Doblar en valle.
Valley-fold.

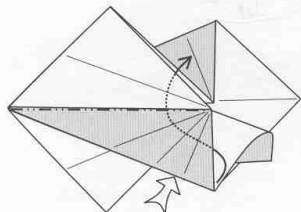

18. Revertir.
Reverse-fold.

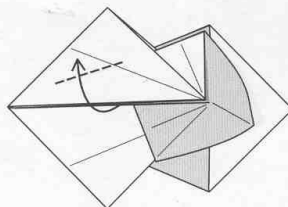

19. Abrir una aleta como en el paso 15.
Open upper flap as in step 15.

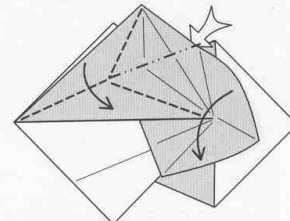

20. Incorporar un doblez revertido como en el paso 16. Esta vez si quedará plano.
Incorporate this reverse fold as in step 16. This time it will lie flat.

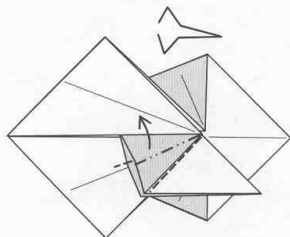

21. Abrir y aplastar manteniendo cerrada la parte blanca de la aleta.
Squash-fold keeping the white part closed.

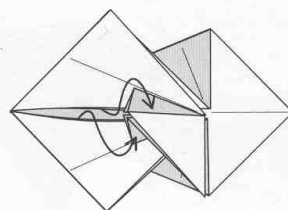

22. Meter las aletitas debajo de 2 capas.
Tuck the little flaps under two layers.

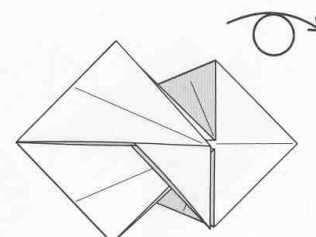

23.



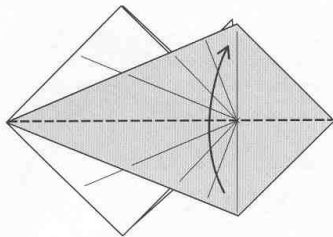

24. Doblar en valle.
Valley-fold.

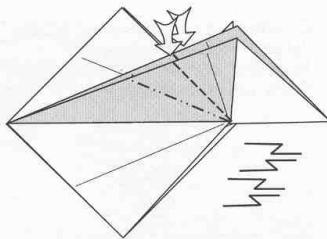

25. Escalonar los dos lados al mismo tiempo.
Crimp-fold both sides at the same time.

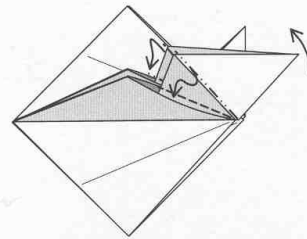

26. Escalonar trabando las aletas dentro de los bolsillos.
Crimp-fold and tuck the little flaps into the pockets.

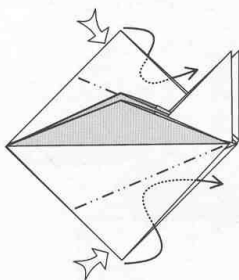

27. Revertir.
Reverse-fold.

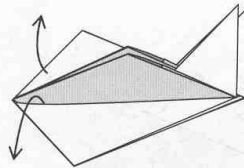

28. Desenvolver con cuidado.
Carefully unwrap.

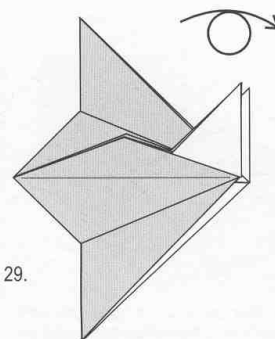

29.

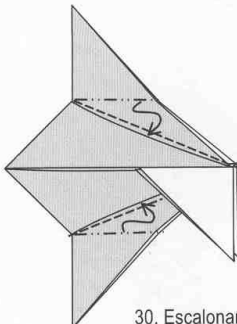

30. Escalonar dos capas juntas y trabar dentro de bolsillos.
Pleat-fold two layers together, then lock inside the pockets.

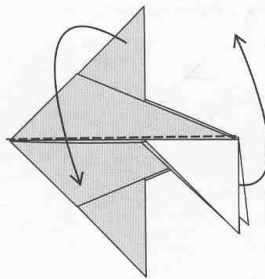

31. Reacomodar las aletas.
Rearrange the fins.

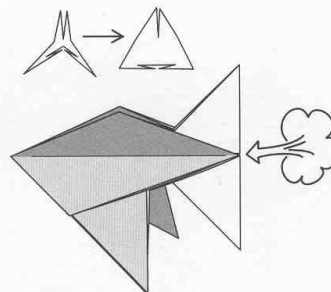

32. Inflar manteniendo juntos los bordes del lomo.
Inflate, holding together the edges that form the spine of the fish.

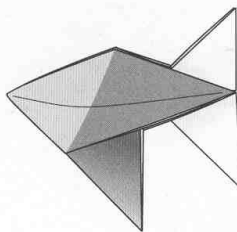

33.

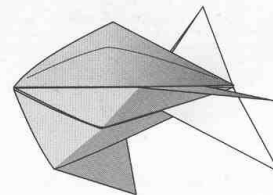
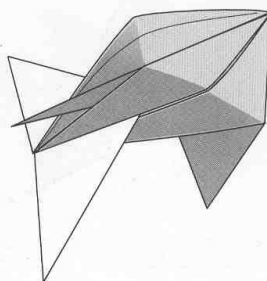

**PEZ
INFLABLE 2**

*INFLATABLE
FISH 2*

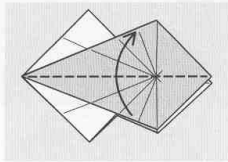

1. Viene del paso 13 del Pez Inflable 1.
This model starts with step 13 of Inflatable Fish 1.

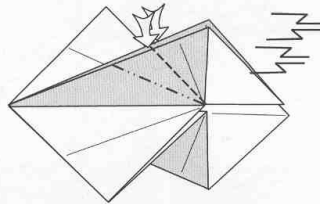
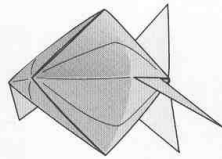

2. Escalonar los dos lados al mismo tiempo.
Crimp-fold both sides at the same time.

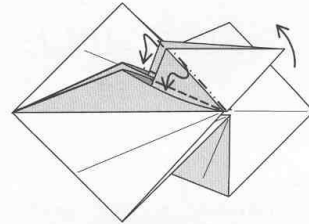

3. Escalonar trabando las aletas dentro de los bolsillos.
Crimp-fold and tuck the little flaps into the pockets.

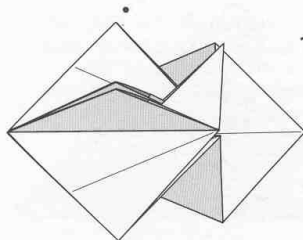

4.

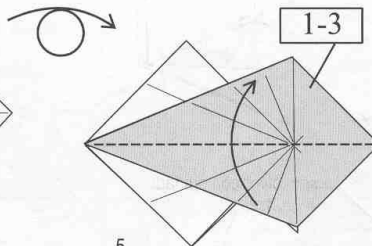

5.

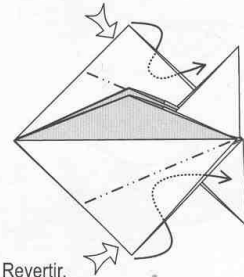

6. Revertir.
Reverse-fold.

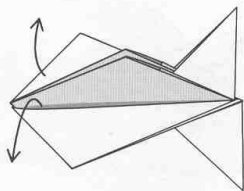

7. Desenvolver con cuidado.
Carefully unwrap.

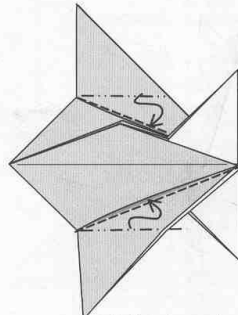

8. Escalonar dos capas juntas y trabar dentro de bolsillos.
Pleat-fold two layers together, then lock inside the pockets.

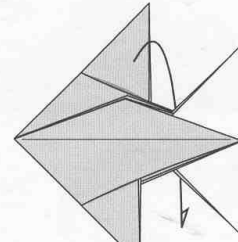

9.

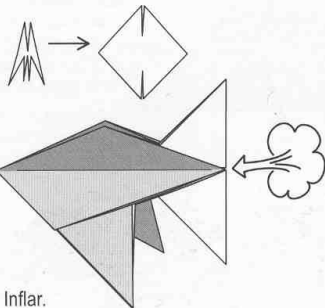

10. Inflar.
Inflate.

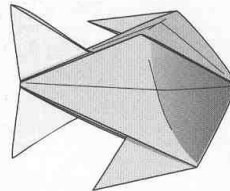

11.



CERDITO INFLABLE

INFLATABLE PIGGY

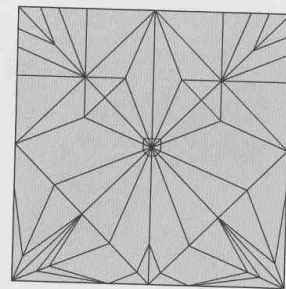
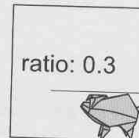
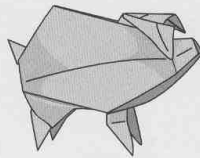

Nivel 2
 Papel favorito: "Tant" color rosado.
 Tamaño recomendado: 15 a 20 cm.
 Comentarios: doblar en seco.

Level 2
 Favorite paper: pink Tant paper.
 Recommended size: 15 to 20 cm.
 Comments: dry-fold.

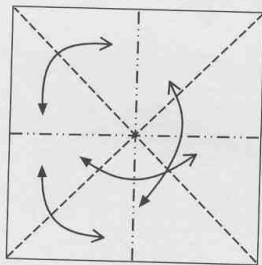

1.

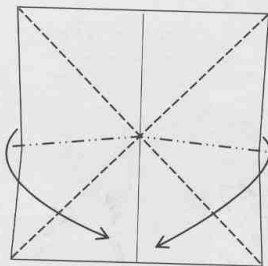

2. Doblar una base de bomba de agua.
 Fold a waterbomb base.

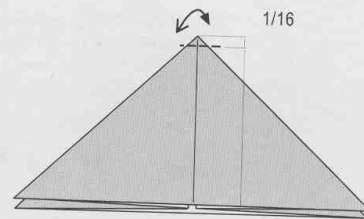

3. Marcar. La referencia es aproximada.
 Crease. The reference is approximate.

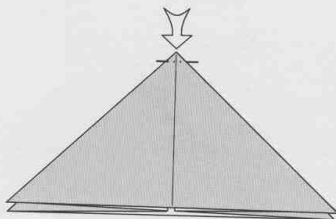

4. Hundir abierto.
 Open sink.

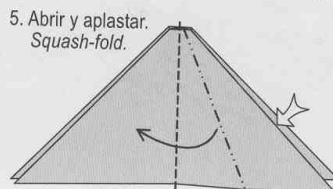

5. Abrir y aplastar.
 Squash-fold.

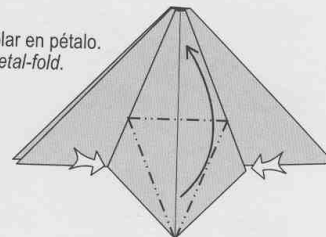

6. Doblar en pétalo.
 Petal-fold.

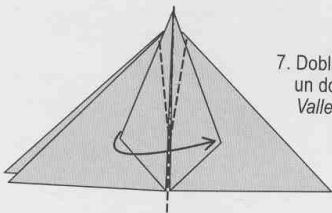

7. Doblar en valle incorporando un doblez reverse delgado.
 Valley-fold incorporating a thin reverse-fold.

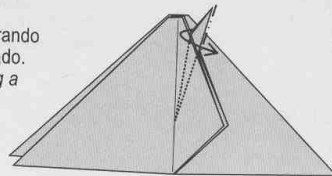

8. Abrir las dos mitades de la aleta cuidando de hacerlo en toda su longitud.
 Open the two halves of this flap. Be careful to do it along its full length.

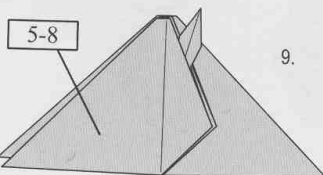

9.

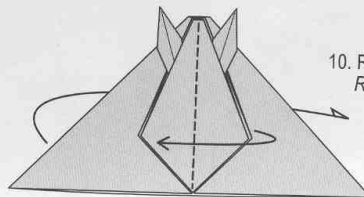

10. Reacomodar las aletas.
 Rearrange the flaps.



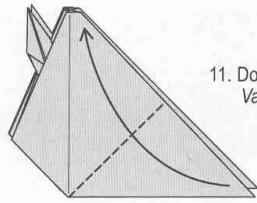

11. Doblar en valle.
Valley-fold.

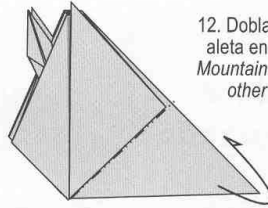

12. Doblar la otra
aleta en monte.
Mountain-fold the
other flap.

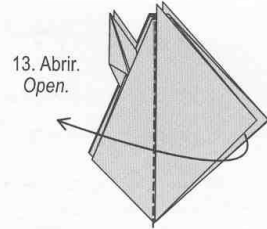

13. Abrir.
Open.

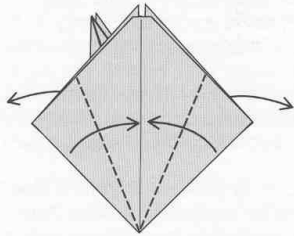

14. Doblar los bordes hacia el centro.
Permitir que las puntas giren hacia afuera.
Fold the edges to the center.
Allow the back flaps to flip to the sides.

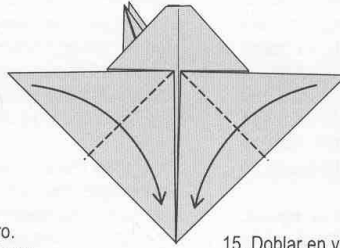

15. Doblar en valle.
Valley-fold.

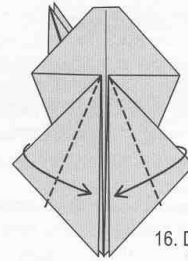

16. Doblar en valle.
Valley-fold.

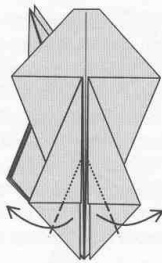

17. Doblar las puntas en valle.
Parte del pliegue queda oculto.
No hay referencia exacta.
Valley-fold the points.
Part of the fold is hidden.
There is no reference.

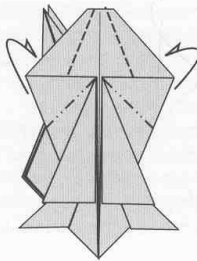

18. Revertir.
Reverse-fold.

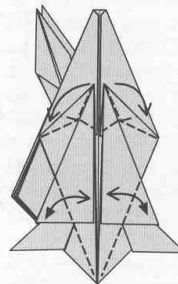

19. Hacer dos orejas de conejo
para las patas delanteras y
marcar firmemente las traseras.
Fold two rabbit-ears for the front legs
and crease the rear legs firmly.

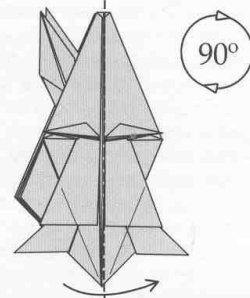

20. Cerrar y rotar.
Close and rotate.

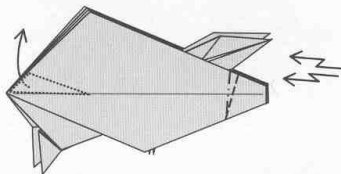

21. Escalonar el morro simétricamente.
Hacer un reverso en la aleta
central para la cola.
Crimp-fold the snout symmetrically.
Reverse-fold the central flap as
shown to make the tail.

22. Dar forma al trasero
doblado hacia adentro.
Fold the bottom flap at the rear
of the model up, and the two
sides in, hiding some paper.

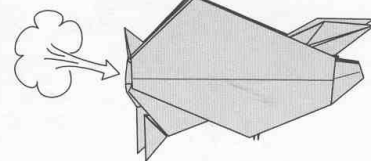
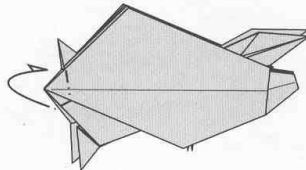

23. Inflar sujetando las capas
del lomo juntas.
Hold the top of the model while
inflating it. This will flatten the
belly, giving a triangular cross-section.

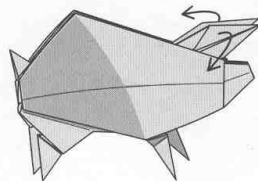

24. Acomodar las orejas
y dar los toques finales.
Shape the ears and
add some final touches.

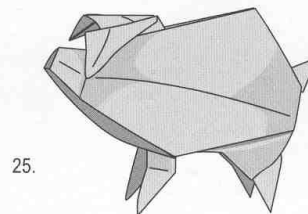

25.



COLILARGO

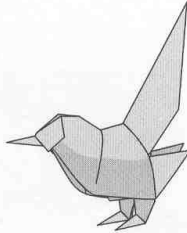

LONG-TAILED BIRD

ratio: 0.64

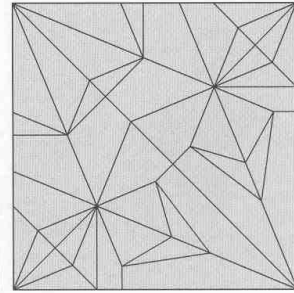
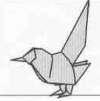

Nivel 1

Papel favorito: Cualquier papel firme y no demasiado delgado.

Tamaño recomendado: 20 cm.

Comentarios: doblar en húmedo.

Level 1

Favorite paper: Any firm, not too thin paper.

Recommended size: 20 cm.

Comments: wet-fold.

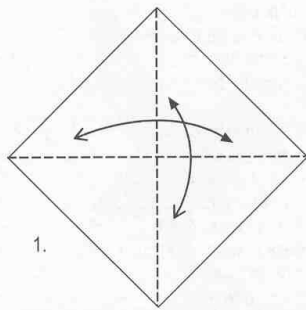

1.

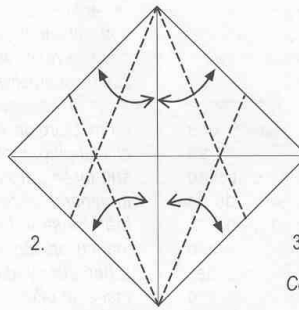

2.

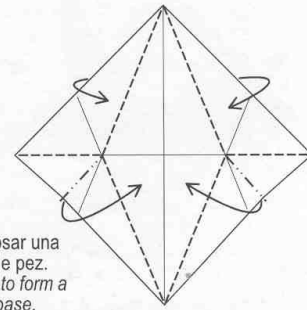

3. Colapsar una base de pez.
Collapse to form a fish-base.

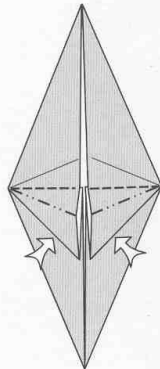

4. Abrir y aplastar las dos aletas pequeñas.
Squash-fold the two small flaps.

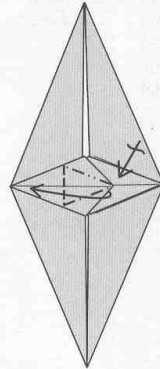

5. Doblar en pétalo de un lado, luego del otro.
Petal-fold one flap, then the other.

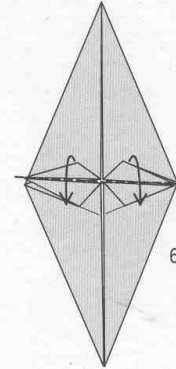

6. Doblar en valle.
Valley-fold.

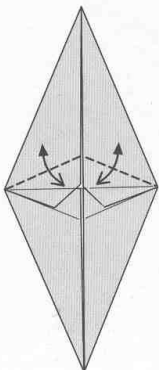

7. Marcar estos dobleces en todas las capas.
Crease these folds through all layers.

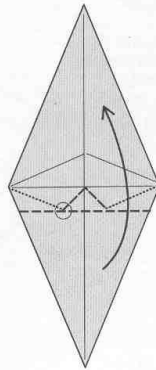

8. Doblar en valle usando como referencia el borde de las aletas que están detrás.
Valley-fold using the flaps on the other side as the reference.

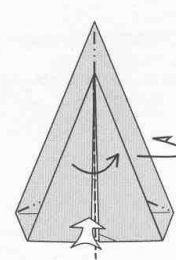

9. Doblar al medio incorporando los dobleces del paso 7.
Fold in half incorporating the folds from step 7.



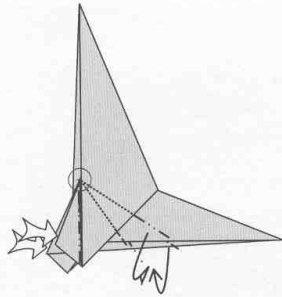

10. Pivotar papel afinando la cola.
Swivel-fold, narrowing the tail.

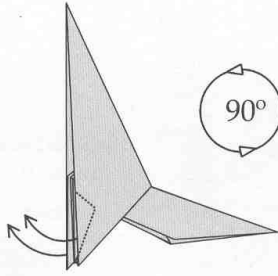

11. Revertir las patas hacia afuera.
Reverse-fold the legs out.

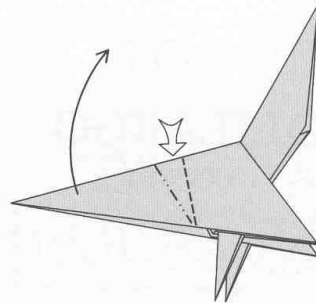

12. Escalonar el cuello.
*No hay una referencia precisa.
Crimp-fold the neck. There is no exact reference.*

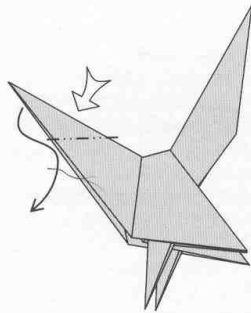

13. Revertir para formar la cabeza.
Reverse-fold to form the head.

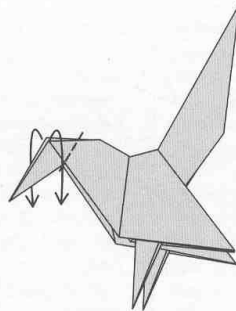

14. Revertir hacia afuera.
Outside reverse-fold.

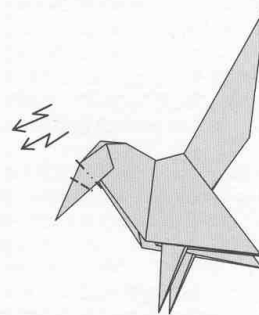

15. Doblar escalonado para formar el pico.
Crimp-fold to make a beak.

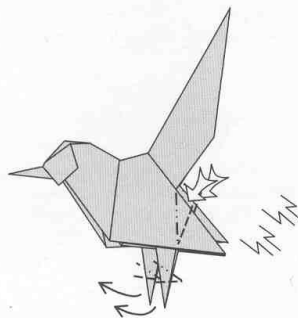

16. Hacer dobleces escalonados para las alas y las patas.
Crimp-fold to shape the wings and the legs.

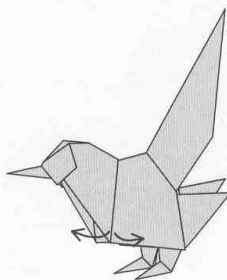

17. Con mucho cuidado separar un poco los dobleces del cuello para que el cuerpo cobre volumen.
Very carefully separate the folds at the throat. At the same time, curve the body making it 3-D.

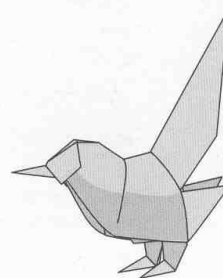

18.



BURRITO

DONKEY

Para Angélica
For Angélica

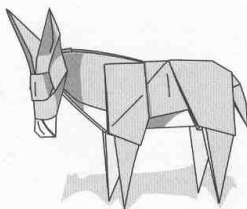

ratio: 0.27

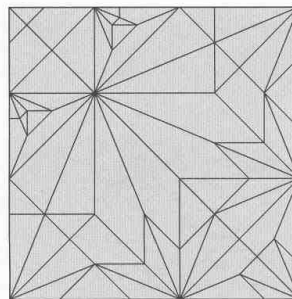

Nivel 3

Papel favorito: Tant pintado de blanco en una cara.

Tamaño recomendado: 35 cm.

Comentarios: doblar en seco o en húmedo.

Level 3

Favorite paper: Tant paper, painted white on one side.

Recommended size: 35 cm.

Comments: dry or wet-fold.

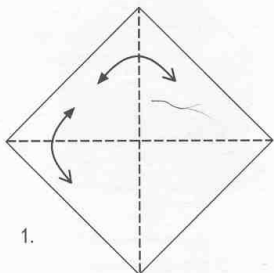

1.

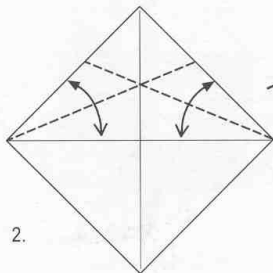

2.

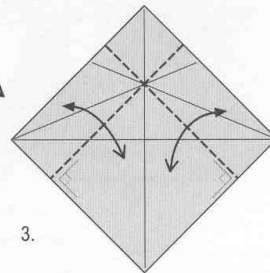

3.

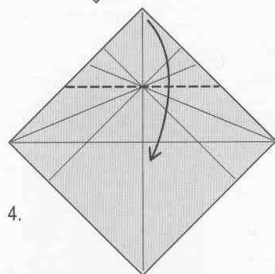

4.

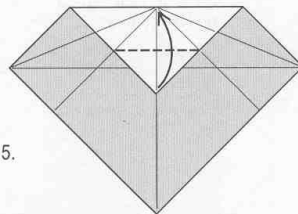

5.

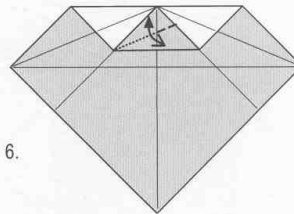

6.

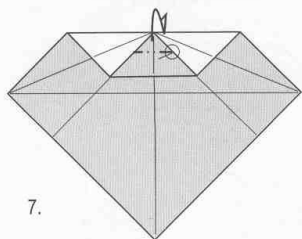

7.

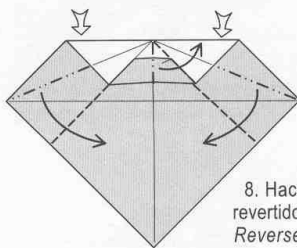

8. Hacer un doblez
revertido de cada lado.
Reverse-fold on each
side.

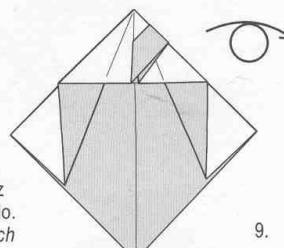

9.

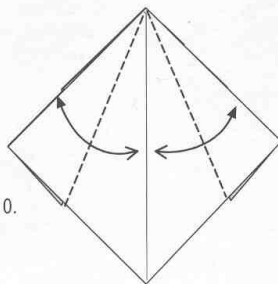

10.

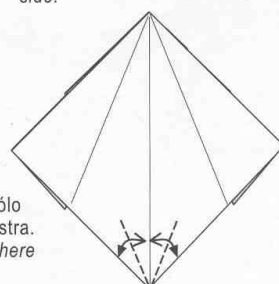

11. Marcar sólo
donde se muestra.
Crease only where
shown.



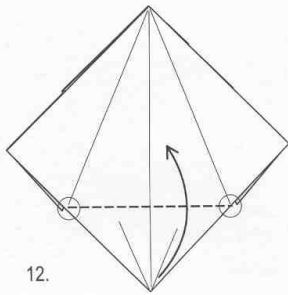

12.

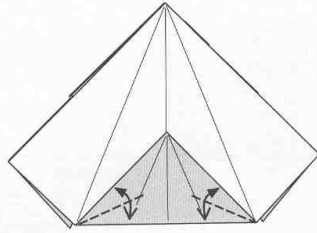

13. Marcar la capa superior.
Crease through the top layer.

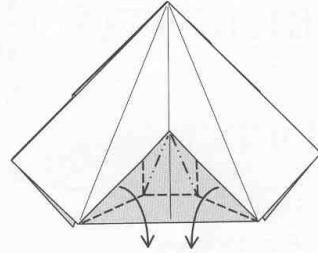

14. Formar una punta para la cola.
Make a point for the tail.

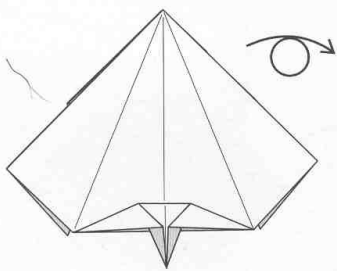

15.

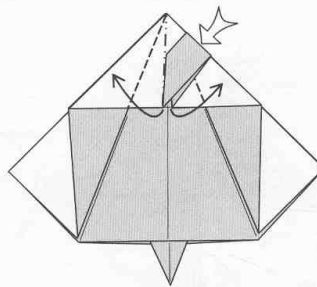

16. Abrir y aplastar.
Squash-fold.

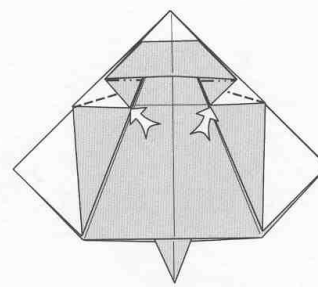

17. Doblez reverso.
Reverse-fold.

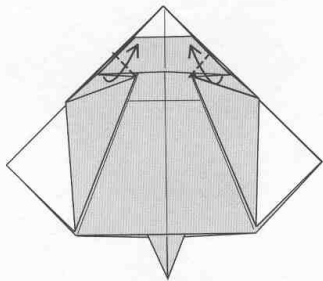

18. Doblar en valle.
Valley-fold.

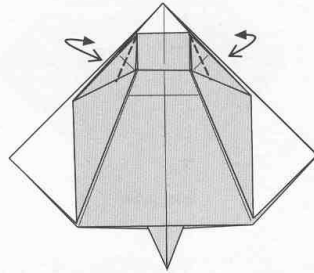

19. Marcar a través de varias capas.
Crease through several layers.

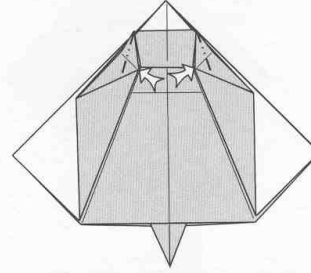

20. Hundir abierto.
Open-sink.

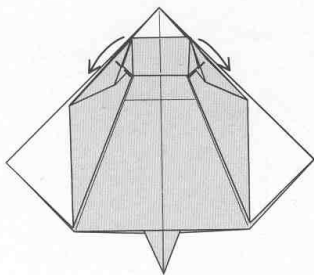

21. Doblar en valle.
Valley-fold.

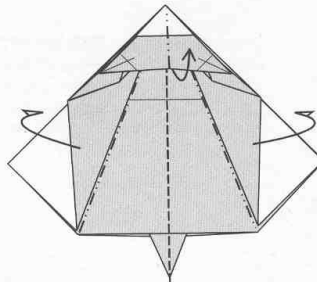

22. Colapsar sobre marcas existentes mientras se levanta en la parte superior.
Collapse on existing creases while lifting an edge on the top.

23. Doblez revertido.
Reverse-fold

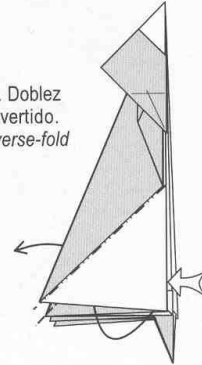

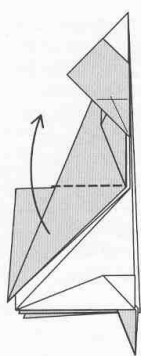

24. Doblar en valle.
Valley-fold.

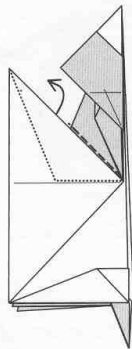

25. Sacar un borde.
Fold out an edge.

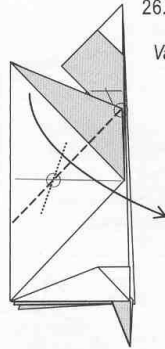

26. Doblar en valle.
Valley-fold.

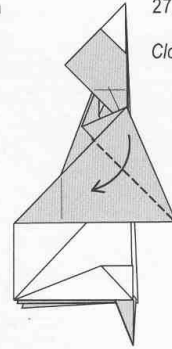

27. Cerrar la pata.
Close the leg now.

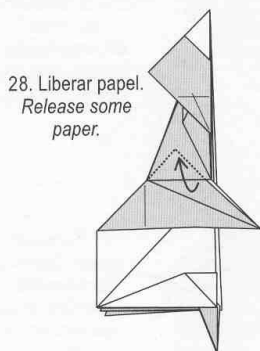

28. Liberar papel.
Release some paper.

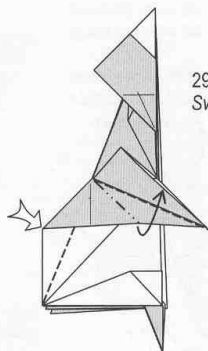

29. Pivotar.
Swivel-fold.

23-29

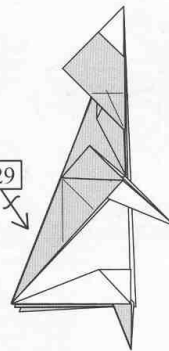

30. Repetir atrás.
Repeat behind.

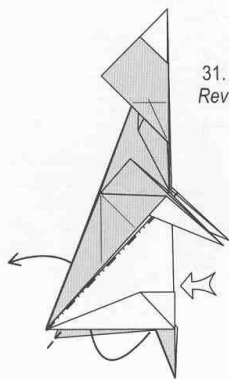

31. Revertir.
Reverse-fold.

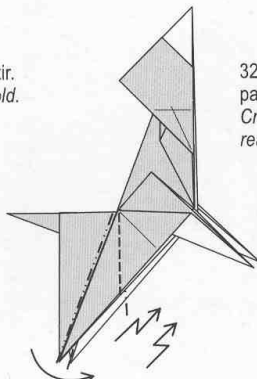

32. Escalonar las patas traseras.
Crimp to form the rear legs.

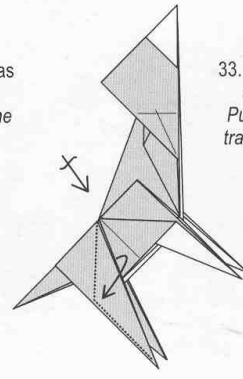

33. Sacar papel atrapado.
Pull out some trapped paper.

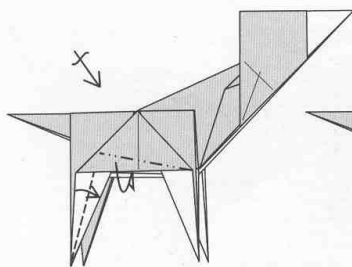

34. Pivotar para mostrar algo de blanco.
Swivel-fold to reveal some white on the belly.

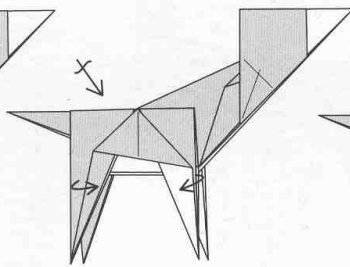

35. Pasar una capa hacia adelante en cada pata.
Bring one layer to the front of each leg.

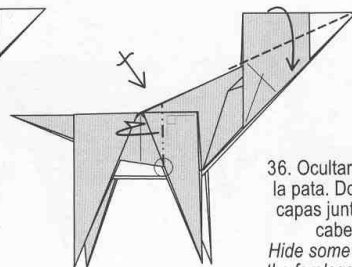

36. Ocultar papel en la pata. Doblar dos capas juntas en la cabeza.
Hide some paper on the forelegs. Fold two layers together on the head.



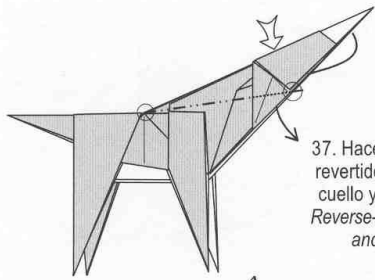

37. Hacer un doblez revertido de todo el cuello y la cabeza.
Reverse-fold the neck and head.

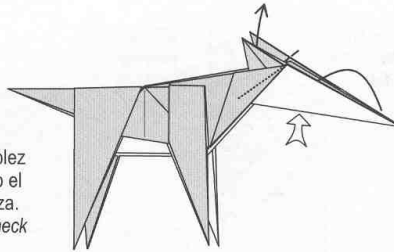

38. La referencia para este paso se ve en el dibujo 39: un borde de las orejas queda alineado con el borde superior del cuello.
The reference point for this step can be seen in step 39: one of the ear's edges will be aligned with the neck's top edge.

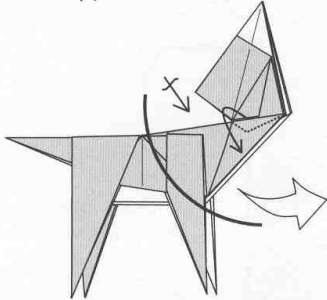

39. Liberar papel atrapado.
Release some trapped paper.

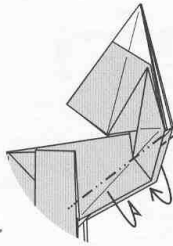

40. Ocultar algo de papel para que se vea una franja blanca.
Hide some paper behind to reveal a white strip.

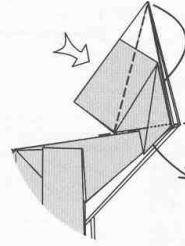

41. Revertir la cabeza sin afectar las orejas.
Reverse-fold the head leaving the ears as they are.

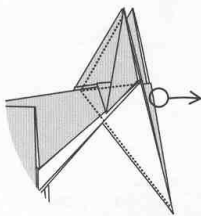

42. Sacar papel de adentro.
Take out paper from the inside of the head.

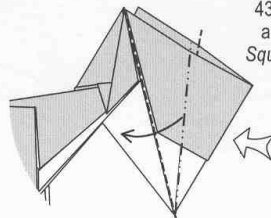

43. Abrir y aplastar.
Squash-fold.

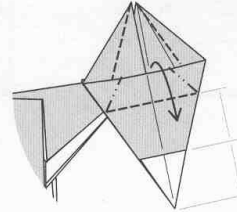

44. Doblar en pétalo. Observar la referencia.
Petal-fold using the references shown.

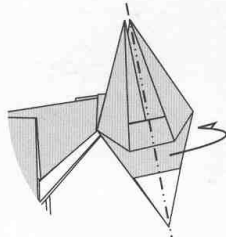

45. Cerrar la cabeza.
Close the head.

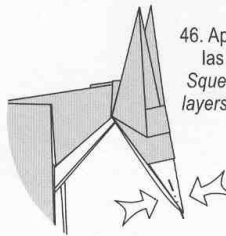

46. Apretar todas las capas...
Squeeze all the layers together...

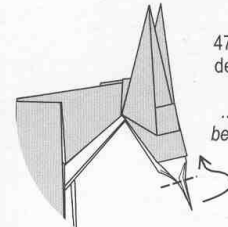

47. ...e insertarlas debajo de la zona de color.
...and tuck them beneath the colored paper.

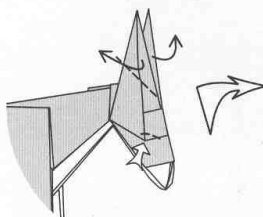

48. Dar forma a las orejas.
Shape the ears.

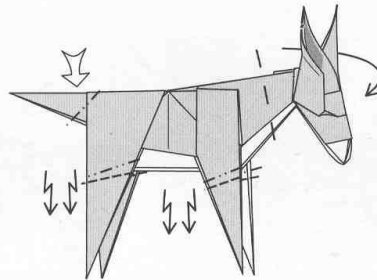

49. Escalonar las patas, revertir en la cola y girar el cuello a gusto.
Crimp the legs, reverse-fold the tail and rotate the neck to taste.

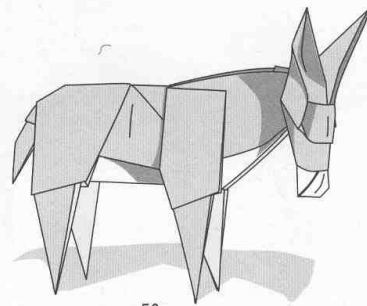

50.



BUHO OWL

Para Nicolas
For Nicolas

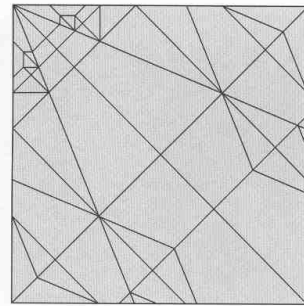
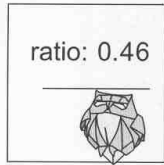
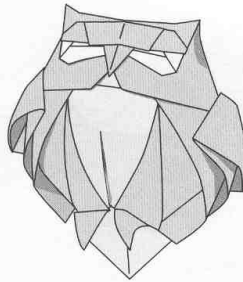

Nivel 3
Papel favorito: papel elefante pintado en una cara.
Tamaño recomendado: 30 cm.
Comentarios: doblar en húmedo.

Level 3
Favorite paper: Elephant Hide paper, painted on one side.
Recommended size: 30 cm.
Comments: wet-fold.

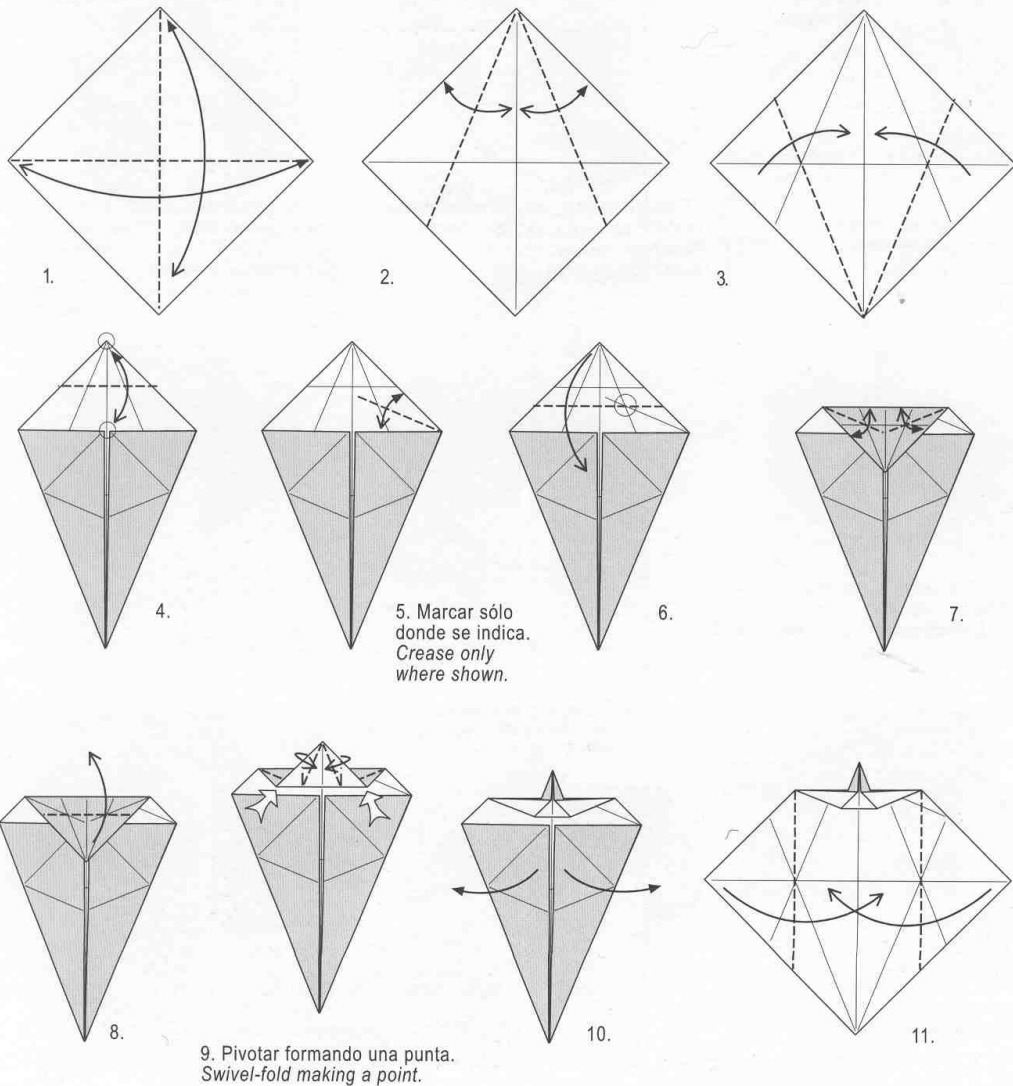

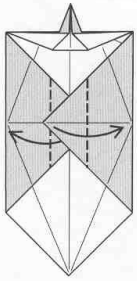

12. Llevar las esquinas hasta el borde.
Fold the corners to the edge.

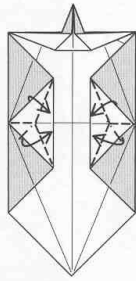

13. Hacer orejas de conejo en las puntas blancas.
Rabbit-ear the white points.

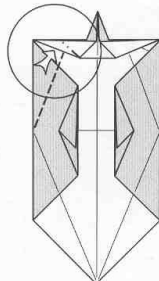

14.

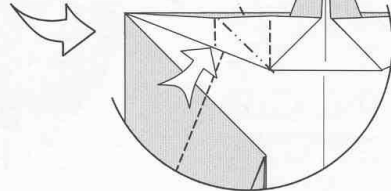

15. Doblar la esquina en valle mientras se abre papel en la parte superior.
Valley-fold the corner while opening paper on the top.

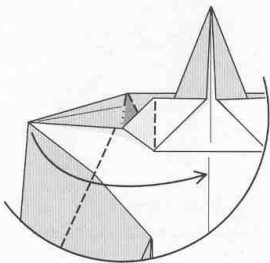

16. Paso intermedio.
Intermediate step.

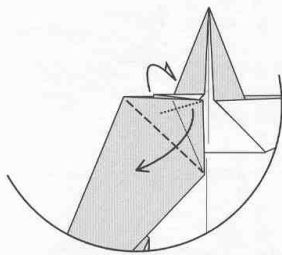

17. Doblar la esquina en valle mientras se debe aplastar un borde interno.
Valley-fold the corner while squashing an edge inside.

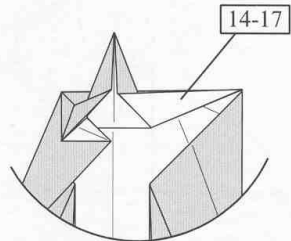

18.

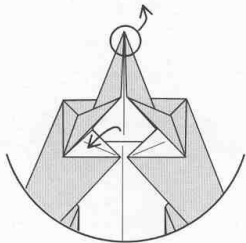

19. Tirar de la punta para liberar un borde.
Pull the tip up to free an edge inside.

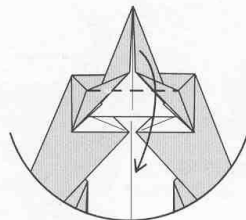

20.

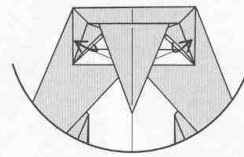

21. Liberar papel.
Free some paper.

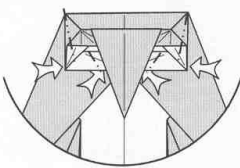

22. Deslizar una capa cambiando la forma de los ojos. Cuidar la simetría.
Slide some paper under changing the shape of the eyes. Keep them symmetrical.

23. Escalonar el pico.
Form the beak with a crimp.

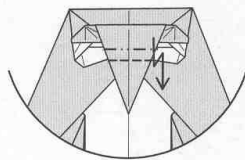

24.

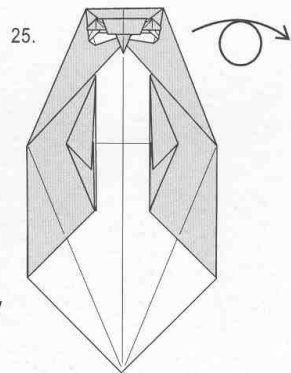
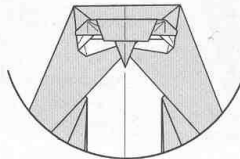

25.

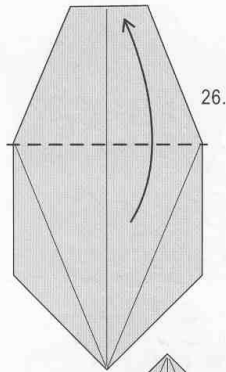

26.

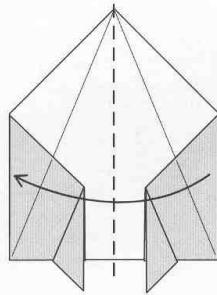

27.

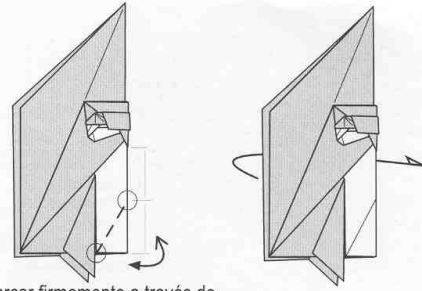

28. Marcar firmemente a través de todas las capas. La referencia es aproximada.
Crease firmly through all layers. The reference is approximate.

29.

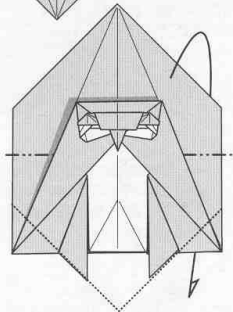

30. Doblar la punta en monte de manera que los bordes coincidan con las patas.
Mountain-fold the point behind so that the edges align with the legs as shown.

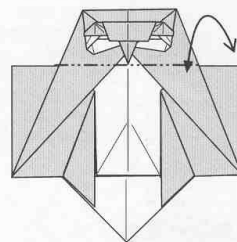

31. Marcar el cuello en monte siguiendo el borde que tiene detrás.
Fold and unfold the neck following the edge behind.

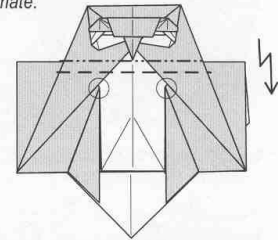

32. Escalonar el cuello llevando la marca del doblez anterior hasta las referencias.
Pleat the neck bringing the crease of the previous fold to the reference points shown.

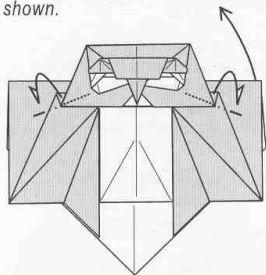

33. Doblar en monte, trabando. Luego desdoblar la punta de atrás.
Lock with mountain folds. Then unfold the point behind.

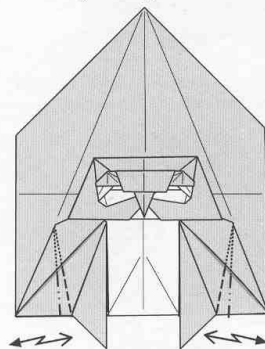

34. Doblar y desdoblar dos pliegues escalonados a través de casi todas las capas excepto la superior.
Fold and unfold two crimps through all the layers except the top one.

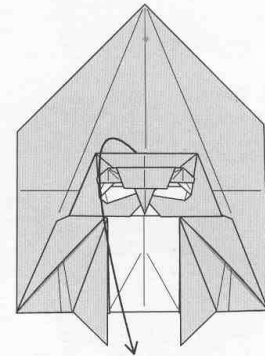

35. Abrir el modelo.
Open the model.

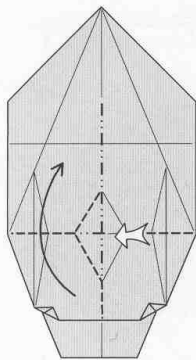

36. Cerrar nuevamente incorporando el pliegue del paso 28. Esto le dará volumen de ahora en adelante.
Close up again incorporating an internal crimp that uses creases from step 28. The model will no longer lie flat.

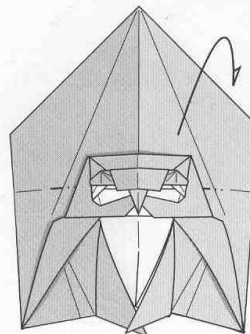

37. Doblar la punta en monte. No marcar el doblez aun.
Mountain-fold the back flap again. Do not crease firmly yet.

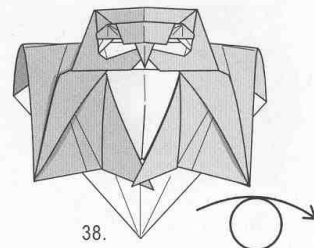

38.



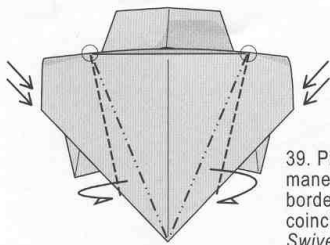

39. Pivotar de manera que los bordes laterales coincidan.
Swivel-fold so that the edges of the sides line up.

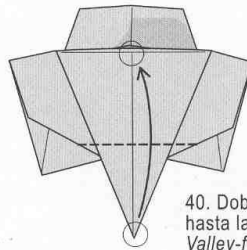

40. Doblar en valle hasta la marca.
Valley-fold to the reference point.

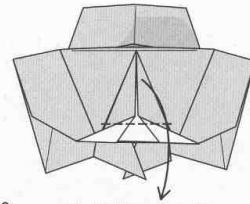

41. Doblar en valle sin referencia.
Valley-fold with no reference point.

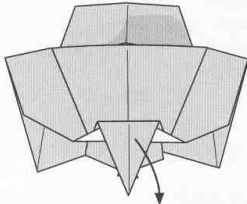

42. Desdoblar hasta el paso 38.
Unfold to step 38.

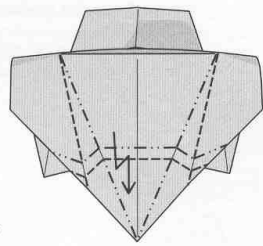

43. Redoblar todo, esta vez escalonando cada capa separadamente.
Refold everything, this time crimping the layers separately.

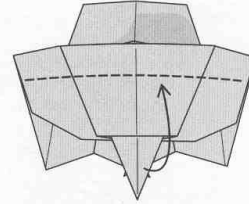

44. Levantar la aleta para ver detrás, evitar dejar marcas.
Lift the flap to see behind, try not to crease.

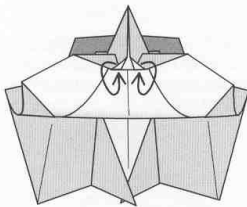

45. Envolver las esquinitas blancas cambiando el color.
Wrap the little white corners around, changing color.

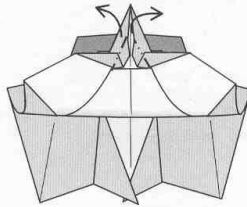

46. Pivotar para ensanchar la aleta.
Swivel to make the flap wider.

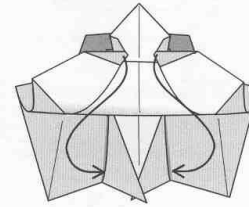

47. Cerrar la aleta e insertar los lados de la cola en los bolsillos detrás de las patas.
Close down the flap and tuck the sides of the tail in the pockets behind the legs.

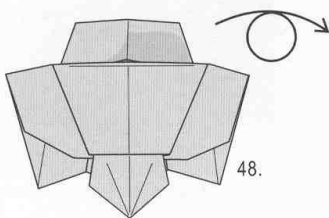

48.

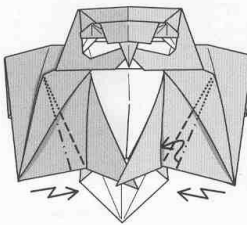

49. Doblar los escalones del paso 34 e insertarlos debajo de las patas.
Fold the crimps from step 34 and tuck them under the legs.

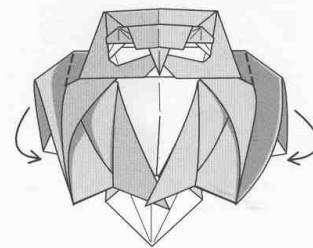

50. Plegar las alas contra el cuerpo.
Fold the wings against the body.

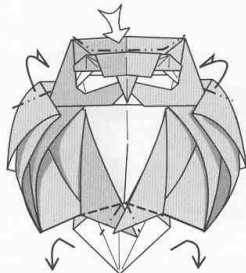

51. Dar forma a las patas y las orejuelas en la frente. Trabar las alas con pequeños dobleces en monte en los hombros.
Shape the legs and the horns on the forehead. Lock the wings with mountain folds on the shoulders.

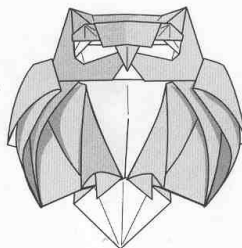

52.

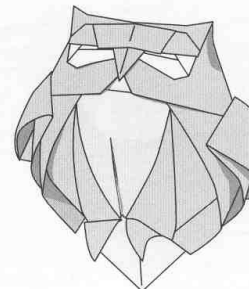

CARDENAL CANTOR

SINGING CARDINAL

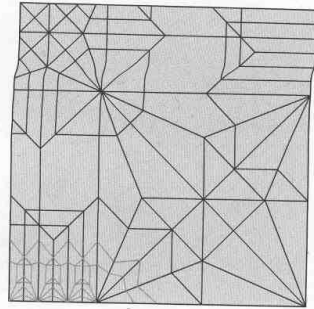
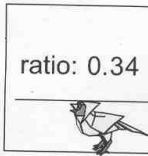
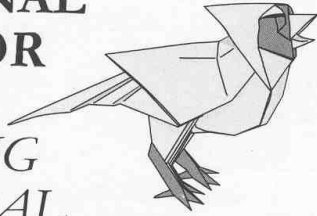

Nivel 4
Papel favorito: Banana rojo y seda negro.
Tamaño recomendado: 25 a 30 cm.
Comentarios: doblar en húmedo.

Level 4
Favorite paper: red Banana paper and black tissue paper.
Recommended size: 25 to 30 cm.
Comments: wet-fold.

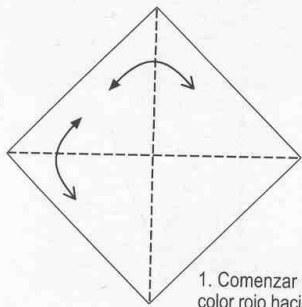

1. Comenzar con el color rojo hacia arriba.
Start red side up.

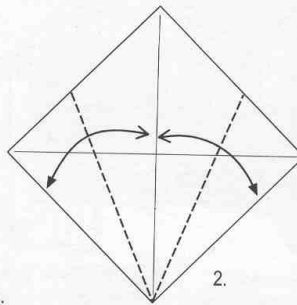

2.

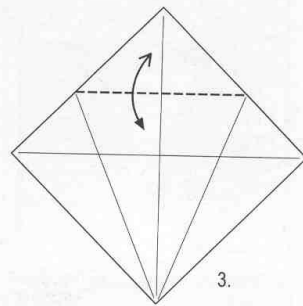

3.

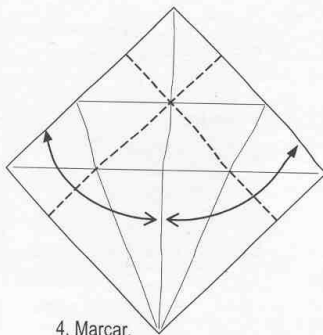

4. Marcar.
Crease.

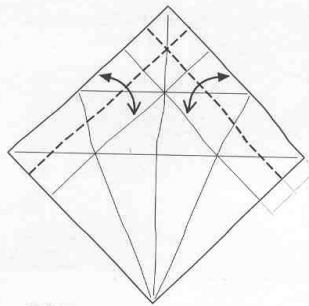

5. Marcar.
Crease.

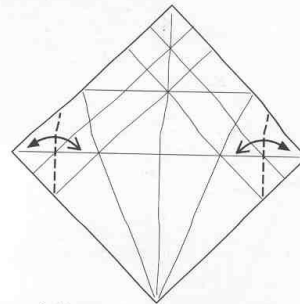

6. Marcar.
Crease.

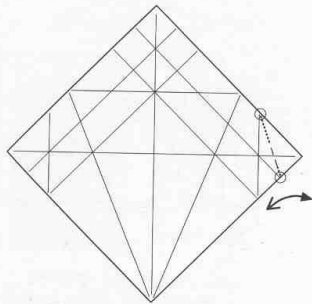

7. Marcar suavemente.
Crease lightly.

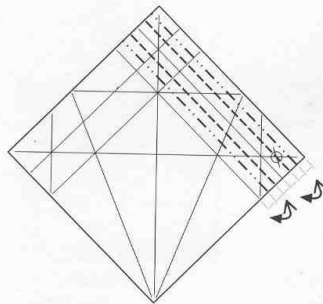

8. Dividir la franja en sextos usando la referencia.
Divide into sixths using the reference point.

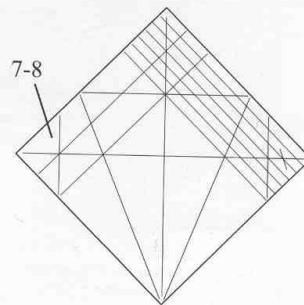

9.



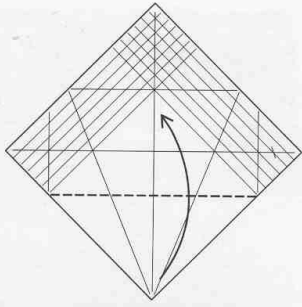

10. Doblar en valle.
Valley-fold.

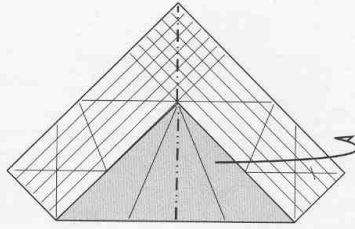

11. Doblar en monte.
Mountain-fold.

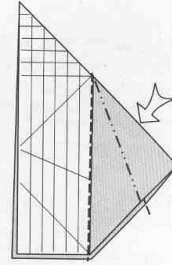

12. Abrir y aplastar.
Squash-fold.

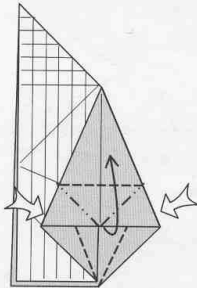

13. Doblar en pétalo.
Petal-fold.

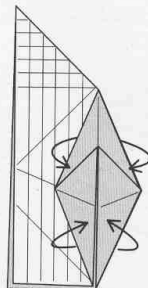

14. Desenvolver una capa y doblarla nuevamente formando una base de pájaro.
Unwrap one layer and refold it like a bird-base.

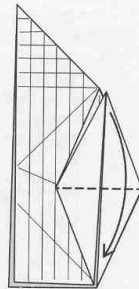

15. Doblar en valle dos aletas.
Valley-fold two flaps down.

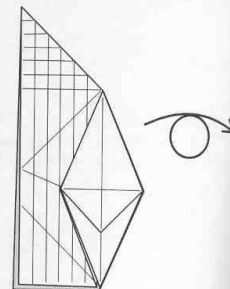

16.

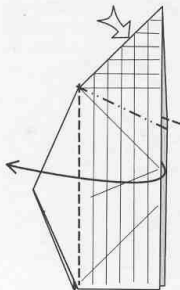

17. Abrir y aplastar.
Squash-fold.

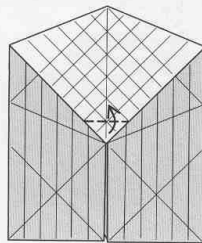

18. Doblar en valle.
Valley-fold.

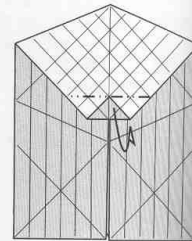

19. Doblar en monte.
Mountain-fold.

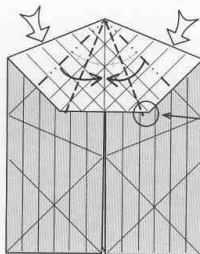

20. Abrir y aplastar de ambos lados.
Los dobleces en monte se hacen sobre marcas existentes.
Squash-fold on both side. The mountain folds are made on existing creases.

no debe coincidir con la esquina
the crease does not go to the corner

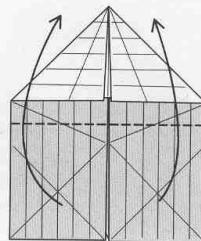

21. Doblar en valle.
Valley-fold in half.

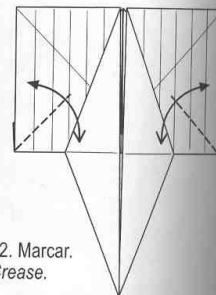

22. Marcar.
Crease.



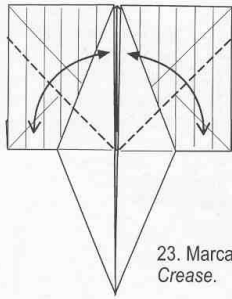

23. Marcar.
Crease.

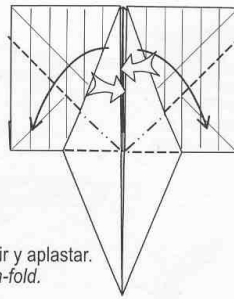

24. Abrir y aplastar.
Squash-fold.

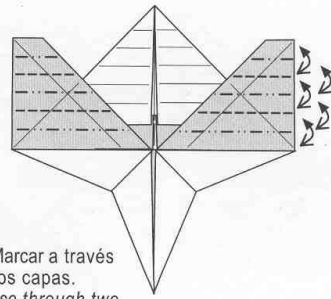

25. Marcar a través
de dos capas.
Crease through two
layers.

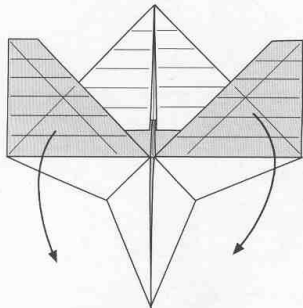

26. Desdoblar hasta el paso 21.
Unfold to step 21.

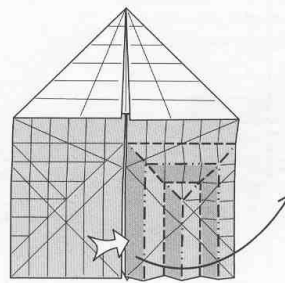

27. Colapsar.
Collapse.

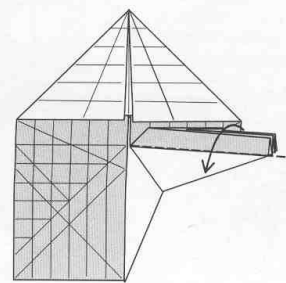

28. Doblar en valle.
Valley-fold.

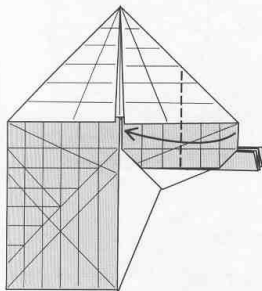

29. Doblar en valle.
Valley-fold.

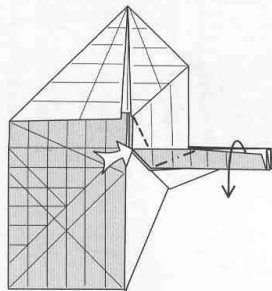

30. Abrir una capa pivotando en la esquina.
Open up a single layer, swivel-folding the corner.

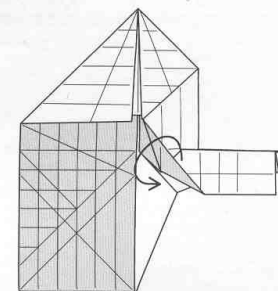

31. Envolver la esquina con mucho cuidado.
Wrap the gusset around the corner carefully.

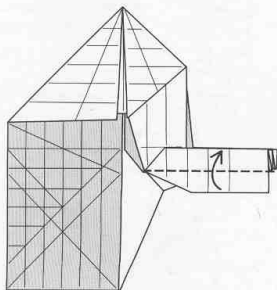

32. Cerrar la capa nuevamente.
Valley-fold the layer back up.

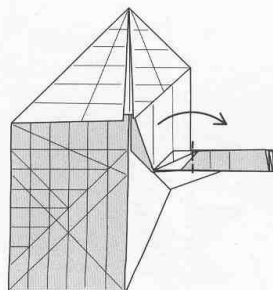

33. Doblar en valle.
Valley-fold.

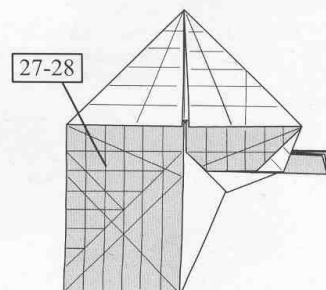

34. Repetir sólo los pasos 27 y 28 de este lado.
Notar que de este lado queda diferente al otro.
Repeat only steps 27 and 28 on the left
Note this side will be different from the other one.



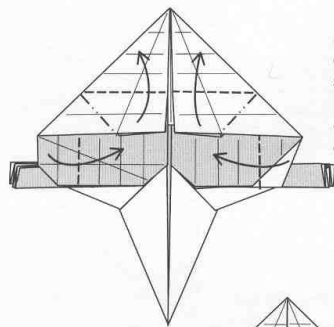

35. Pivotar aplastando una capa detrás. Basarse en el siguiente dibujo.
Swivel-fold squashing a corner behind. See next drawing as a reference.

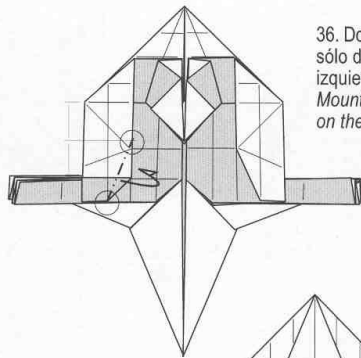

36. Doblar en monte sólo del lado izquierdo.
Mountain-fold only on the left side.

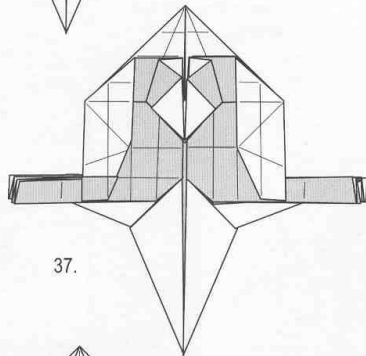

37.

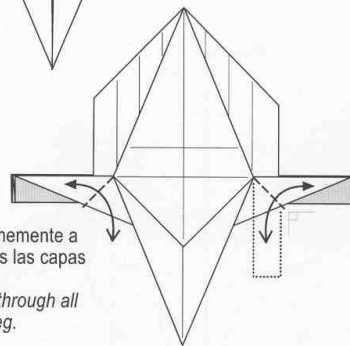
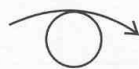

38. Marcar firmemente a través de todas las capas de la pata.
Crease firmly through all layers of the leg.

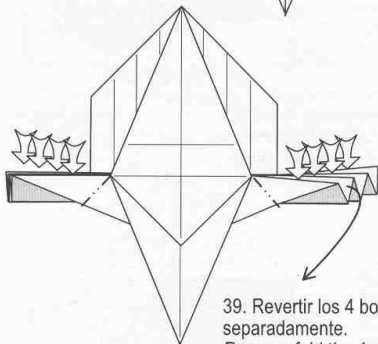

39. Revertir los 4 bordes separadamente.
Reverse-fold the 4 edges separately.

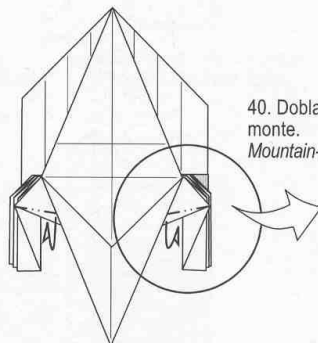

40. Doblar en monte.
Mountain-fold.

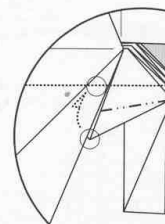

41. Detalle de las referencias.
Detail of the reference points.

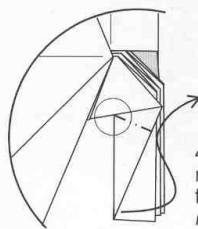

42. Revertir marcando firmemente.
Reverse-fold, creasing firmly.

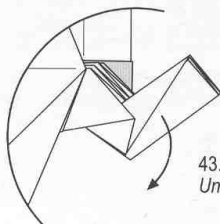

43. Desdoblar.
Unfold.

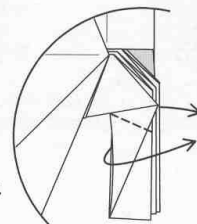

44. Revertir los bordes hacia afuera separadamente para que cambien de color.
Outside reverse-fold the edges separately so they change color.

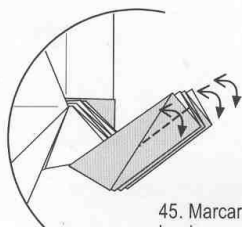

45. Marcar en tres bordes separadamente.
Crease on three edges separately.

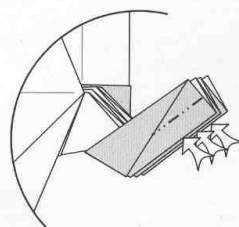

46. Hundir abierto en tres bordes.
Open-sink three edges.

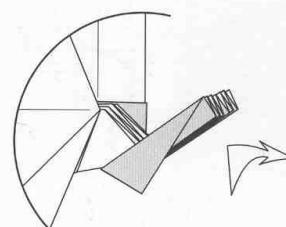

47.



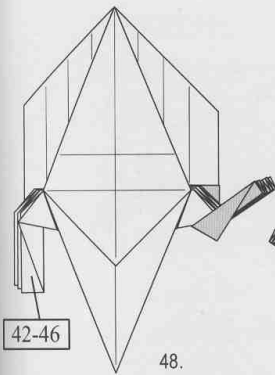

48.

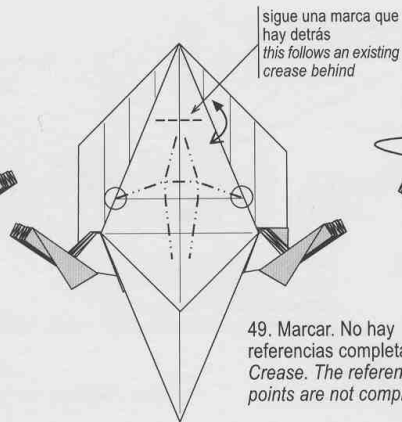

49. Marcar. No hay referencias completas.
Crease. The reference points are not complete.

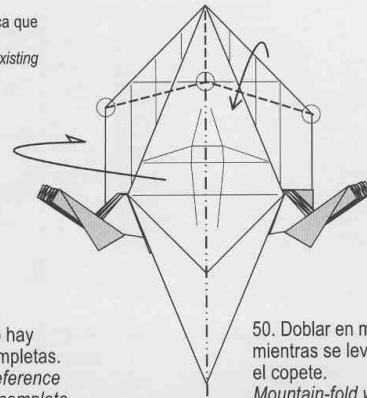

50. Doblar en monte mientras se levanta el copete.
Mountain-fold while lifting the head crest.

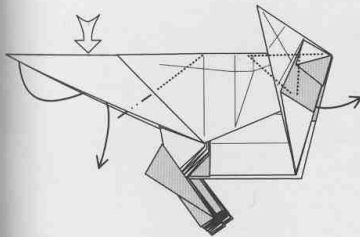

51. Revertir para sacar el pico y para marcar en la cola.
Reverse-fold to extract the beak and to start creasing the tail.

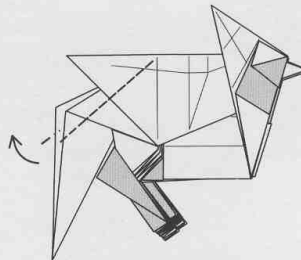

52. Cambiar la posición de la cola y marcar nuevamente.
Change the position of the tail to crease it again.

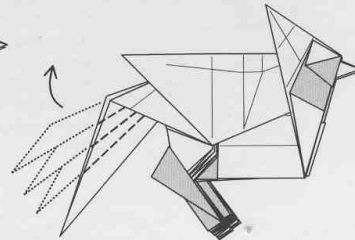

53. Repetir hasta obtener cinco marcas bien firmes.
Repeat until you have five firm creases.

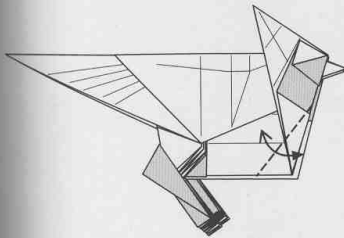

54. Marcar. No hay referencias exactas.
Crease. There are no precise references.

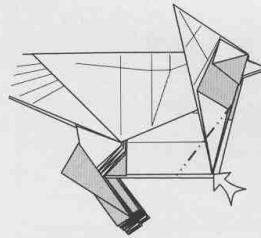

55. Hundir cerrado.
Closed-sink.

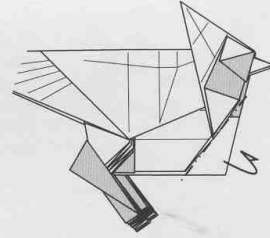

56. Doblar en monte. No meter en ningún bolsillo.
Mountain-fold. Do not tuck into any pocket.

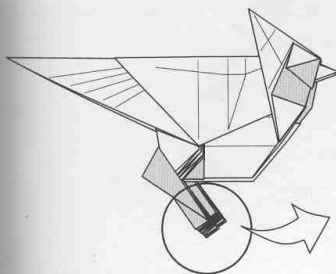

57. Detalle de la formación de los dedos.
Details of how to make the toes.

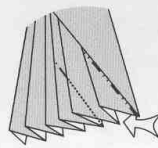

58. Se usan cuatro capas para cada dedo.
Four layers are used for each toe.

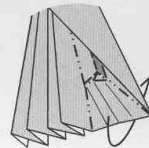

59. Aplanar revertiendo hacia adelante.
Flatten while reverse-folding.

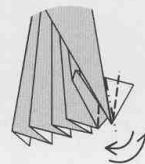

60. Revertir dos veces más.
Reverse-fold two more times.





61.

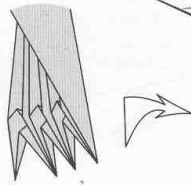

62.

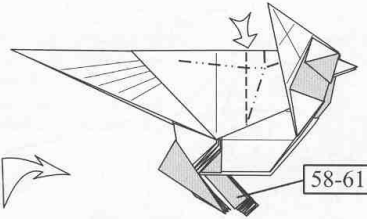

63. Hacer los dedos en la otra pata.
Luego escalonar el lomo con cuidado.
Make the toes on the other leg.
Then crimp the back carefully.

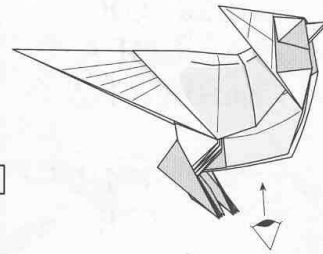

64. Ahora se hace el cierre de la panza.
Now we are going to begin closing the belly.

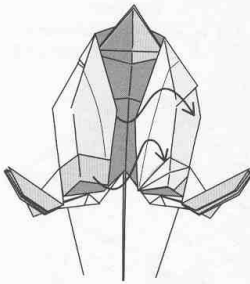

65. Colocar la mitad izquierda sobre la derecha. Notar la traba en la parte inferior.
Bring the left half over the right half. Note the lock at the bottom.

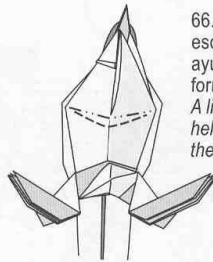

66. Un pequeño escalonado ayuda a dar forma al pecho.
A little crimp helps to shape the chest.

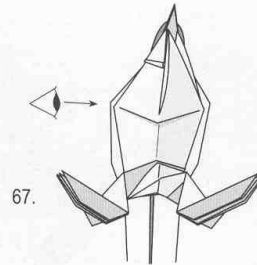

67.

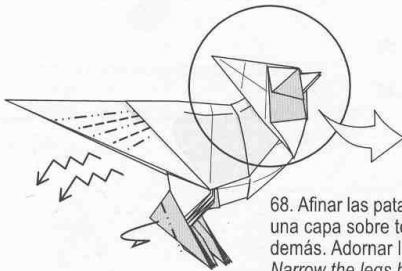

68. Afinar las patas plegando una capa sobre todas las demás. Adornar la cola.
Narrow the legs by wrapping the flap around the back of all the layers. Decorate the tail.

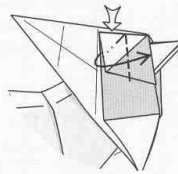

69. Formar los ojos.
Form the eyes.

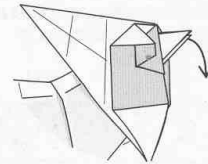

70. Abrir el pico.
Open the beak.

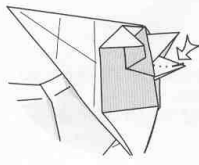

71.

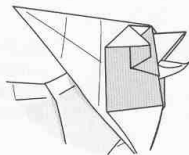

72.

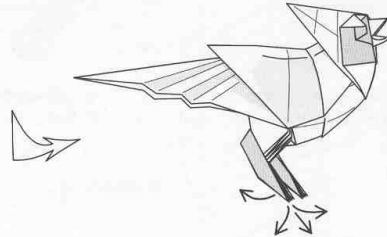

73. Revertir un dedo hacia atrás y abrir los restantes.
Reverse-fold one toe backwards and fan out the other three.

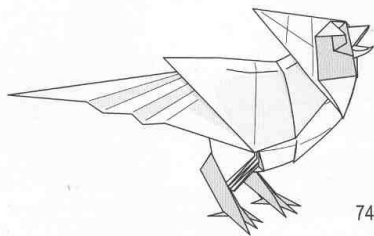

74.

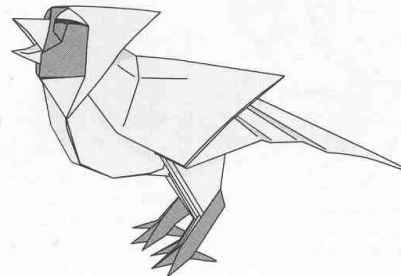

LEMUR DE COLA ANILLADA

RINGED TAILED LEMUR

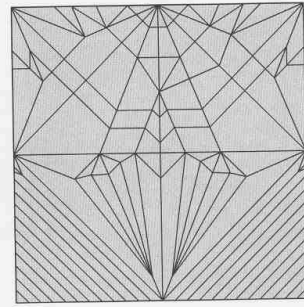
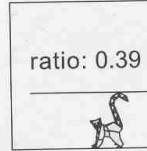
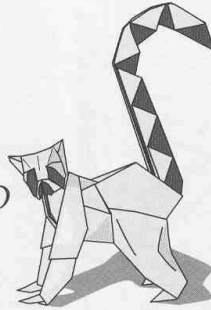

Nivel 4
Papel favorito: Doble seda beige en un lado y negro en el otro.
Tamaño recomendado: 35 cm.
Comentarios: doblar en seco con posibles retoques con metil celulosa.

Level 4
Favorite paper: double tissue paper, beige on one side and black on the other.
Recommended size: 35 cm.
Comments: dry-fold, possibly finishing with methyl cellulose.

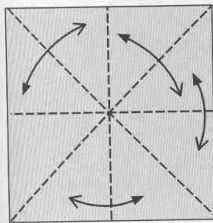

1. Comenzar con el lado oscuro hacia arriba.
Start with the dark side of the paper up.

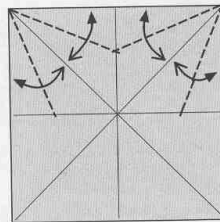

2.

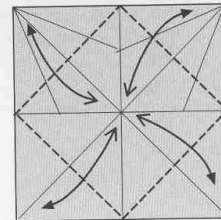

3.

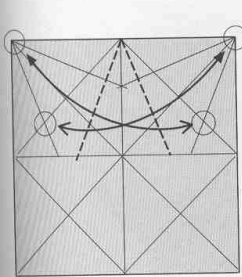

4.

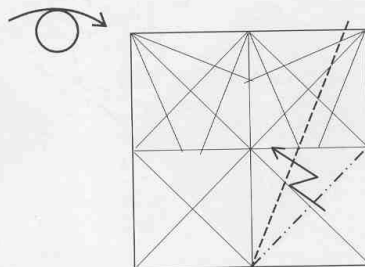

5. Escalonar. El doblez en valle es nuevo.
Crimp-fold. The valley fold is new.

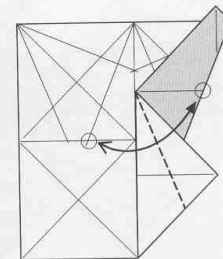

6. Marcar a través de todas las capas.
Crease through all layers.

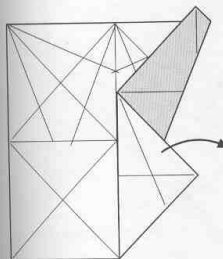

7. Desdoblar.
Unfold.

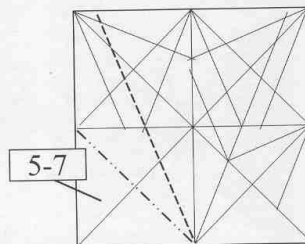

8.

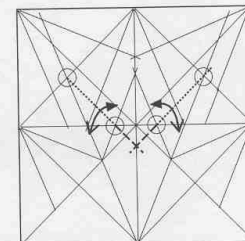

9. Marcar.
Crease.



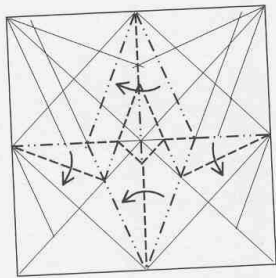

10. Colapsar.
Collapse.

90°

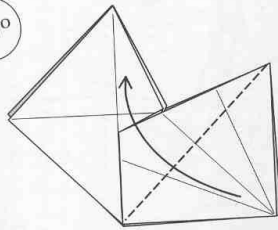

11. Doblar en valle.
Valley-fold.

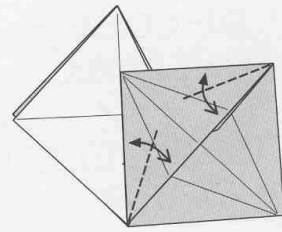

12. Marcar.
Crease.

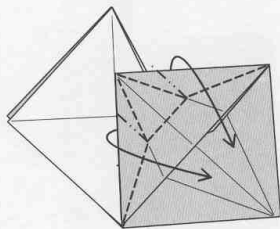

13. Pivotar formando una punta.
Swivel-fold forming a point.

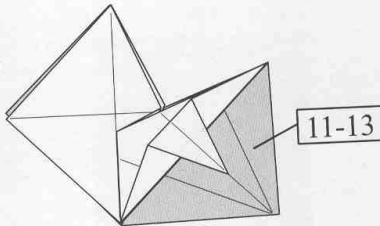

14.

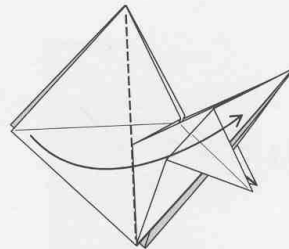

15. Doblar en valle.
Valley-fold.

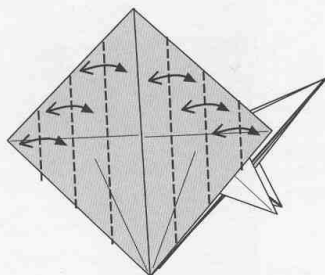

16. Marcar dividiendo cada mitad en cuartos.
Crease, dividing each half into quarters.

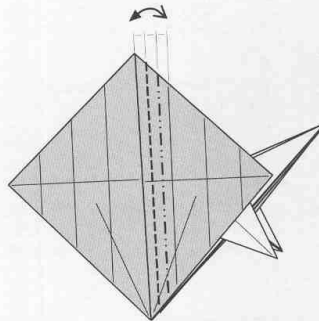

17. Ahora dividir un segmento en tercios.
Now divide one segment into thirds.

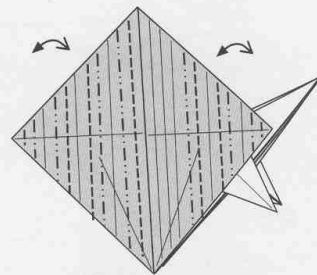

18. Dividir el resto de los segmentos en tercios.
Divide each of the rest of the segments into thirds.

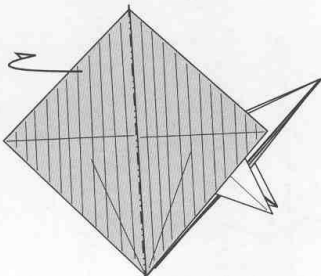

19. Doblar en monte.
Mountain-fold.

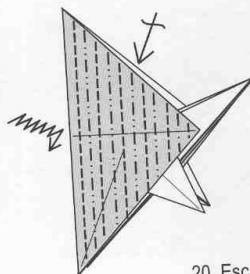

20. Escalonar.
Pleat-fold.

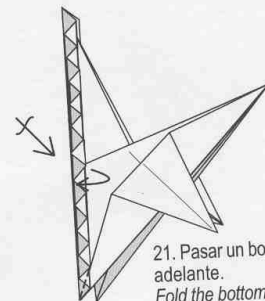

21. Pasar un borde hacia adelante.
Fold the bottom edge up, then bring one edge to the front.



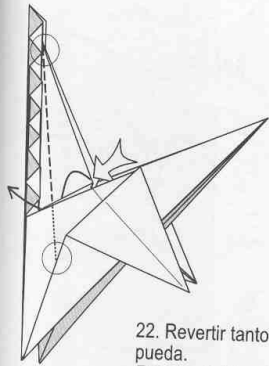

22. Revertir tanto como se pueda.
Reverse-fold as far as possible.

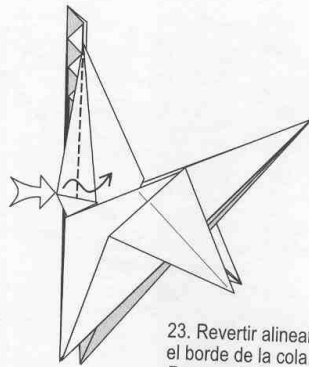

23. Revertir alineando con el borde de la cola.
Reverse-fold, matching the edge of the tail.

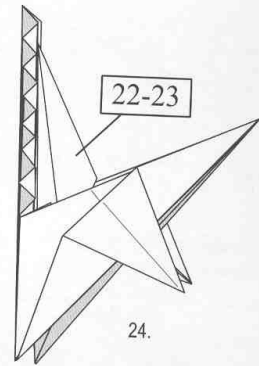

24.

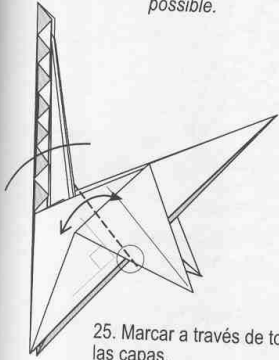

25. Marcar a través de todas las capas.
Crease through all layers.



26. Escalonar todas las capas juntas. Por debajo dejar tres bordes hacia un lado y dos hacia el otro.
Crimp-fold all layers together. From below, leave three edges to one side and two to the other side.

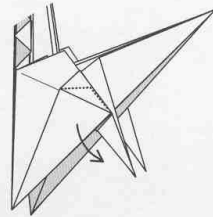

27. Liberar papel atrapado...
Release some trapped paper...

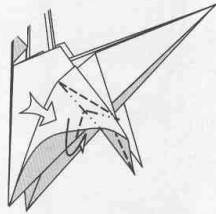

28. ...y doblarlo sobre marcas existentes.
...and refold it using existing creases.

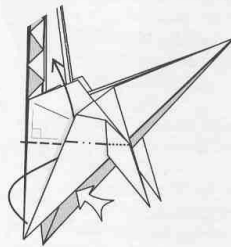

29. Revertir tanto como se pueda.
Reverse-fold as far as possible.

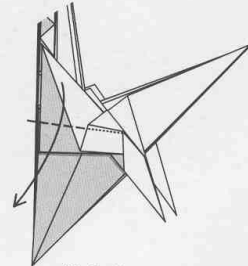

30. Doblar en valle. No hay una referencia exacta.
Valley-fold. There is no exact reference.

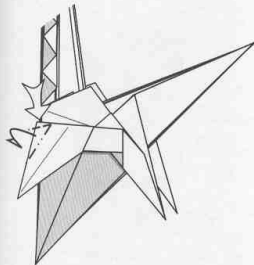

31. Revertir.
Reverse-fold.

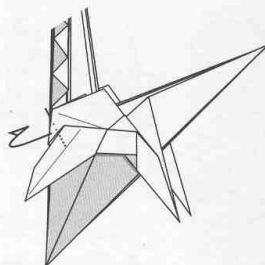

32. Doblar en monte.
Mountain-fold.

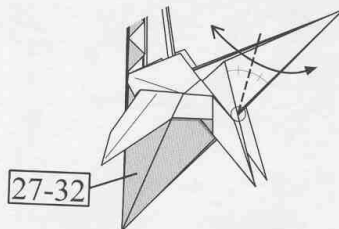

33. Repetir los pasos 27-32 en la otra pata. Marcar una bisectriz en el cuello.
Repeat steps 27-32 on the other leg. Crease an angle bisector on the neck.



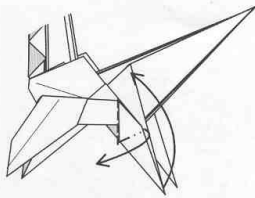

34. Abrir la pata y aplastar.
Squash-fold.

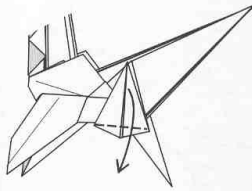

35. Doblar en valle.
Valley-fold.

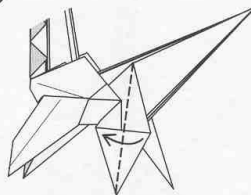

36. Doblar en valle.
Valley-fold.

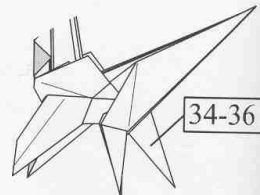

37.

34-36

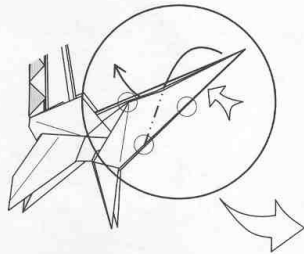

38. Revertir usando la marca
del paso 33.
*Reverse-fold using the crease
made in step 33.*

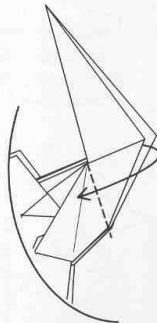

39. Doblar en valle abriendo el cuello.
Valley-fold opening the neck.

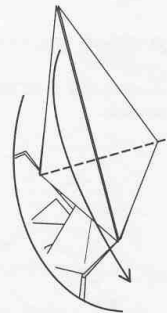

40. Doblar en valle.
Valley-fold.

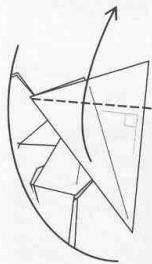

41. Doblar en valle
alineando con el borde
derecho.
*Valley-fold aligning with
the right edge.*

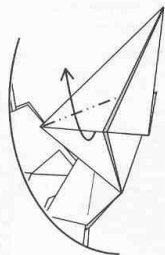

42. Liberar papel
atrapado.
*Released trapped
paper.*

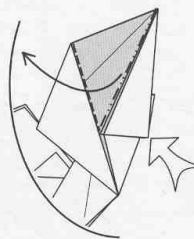

43. Abrir y aplastar.
Squash-fold.

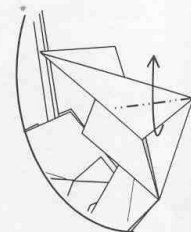

44. Liberar papel atrapado
de este lado ahora.
*Released trapped paper on
the other side now.*

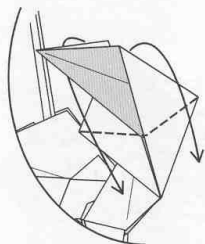

45. Doblar en valle
abriendo la aleta.
*Valley-fold opening the
flap.*

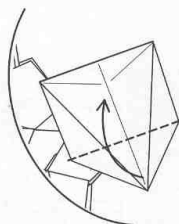

46. Doblar en valle.
Valley-fold.

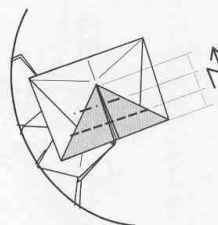

47. Escalonar dividiendo
en tercios.
Pleat, dividing into thirds.

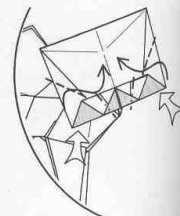

48. Revertir.
Reverse-fold.



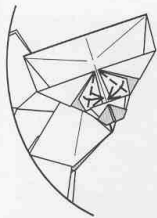

49. Doblar en valle.
Valley-fold.

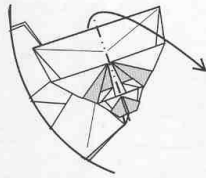

50. Doblar la cabeza en monte.
Mountain-fold the head.

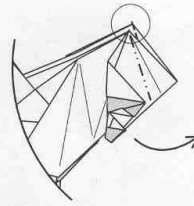

51. Deslizar la cabeza hacia adelante.
La esquina señalada no debe cambiar de posición.
Slide the head forward. The marked point should remain fixed.

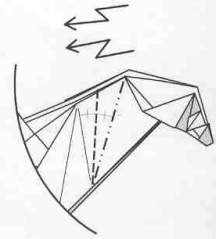

52. Escalonar simétricamente.
Crimp-fold.

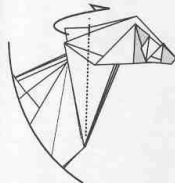

53. Doblar en monte la oreja de atrás.
Mountain-fold the ear behind.

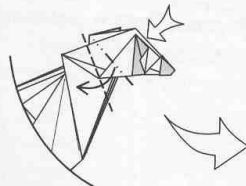

54. Abrir y aplastar toda la cabeza.
Squash-fold the whole head.

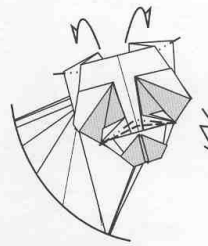

55. Doblar en monte las orejas. Escalonar el hocico en 3D.
Mountain-fold the ears. 3D crimp the nose.

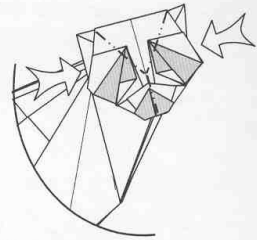

56. Dar forma a la cara con una frente triangular.
Further shape the face with a triangular forehead.

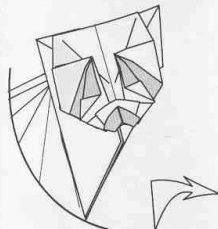

57.

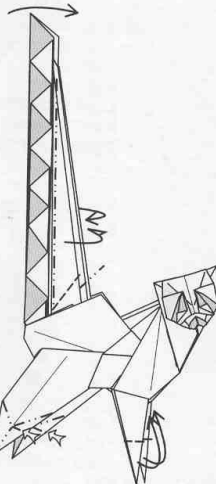

58. Ocultar papel en la cola pivotando todas las capas. Hacer una doble oreja de conejo a las patas traseras y revertir hacia afuera las delanteras.
Hide the spare paper on the tail by swivel-folding all layers. Double-rabbit ear the rear legs and outside reverse-fold the front legs.

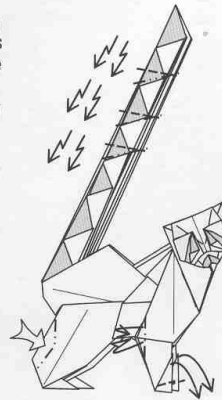

59. Escalonar la cola en tres puntos. Dar forma a las patas como se muestra.
Crimp the tail in three places. Shape the legs as shown

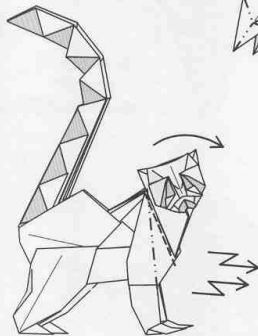

60. Escalonar el cuello metiéndolo entre las patas delanteras.
Crimp the neck, tucking it between the front legs.

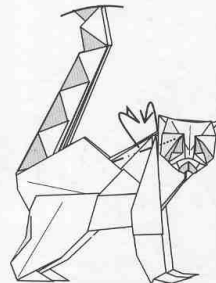

61. Ocultar papel en el cuello. Se deben separar apenas las capas que lo traban.
Hide some paper at the neck. To do this, disengage the edges at the top a little.

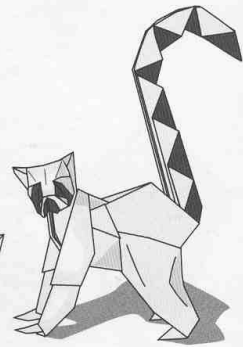
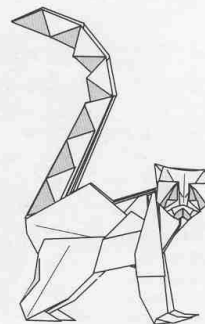

CALANDRIA

MOCKING BIRD

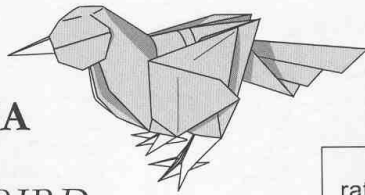

ratio: 0.38

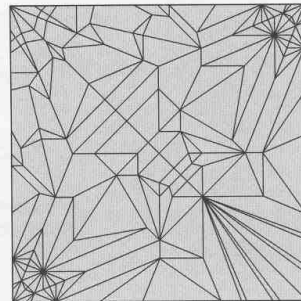

Nivel 3

Papel favorito: Banana con seda.

Tamaño recomendado: 25cm.

Comentarios: doblar en húmedo o en seco.

Level 3

Favorite paper: Banana and tissue paper.

Recommended size: 25cm.

Comments: wet or dry-fold.

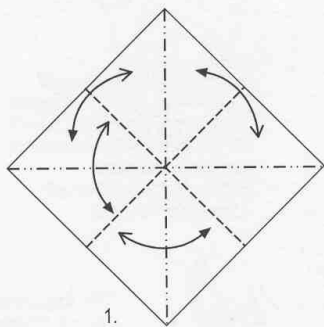

1.

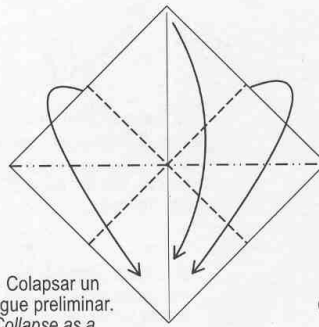

2. Colapsar un pliegue preliminar.
Collapse as a preliminary fold.

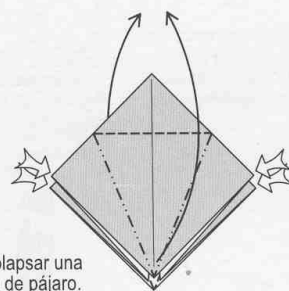

3. Colapsar una base de pájaro.
Collapse as a bird base.

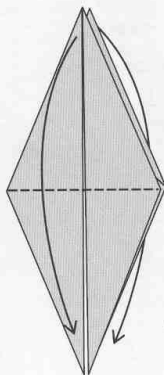

4. Bajar las aletas.
Fold the flaps down.

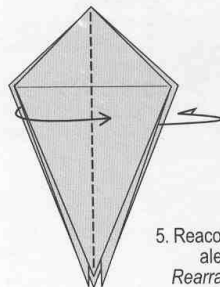

5. Reacomodar las aletas.
Rearrange the flaps

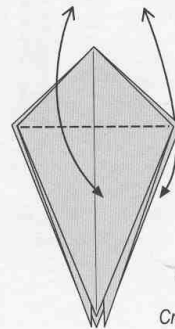

6. Marcar las bisagras.
Crease the hinges.

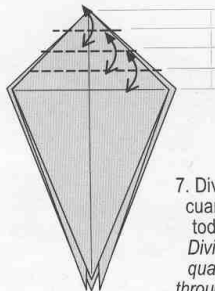

7. Dividir la punta en cuartos marcando todas las capas.
Divide the top into quarters, creasing through all the layers.

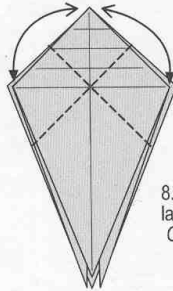

8. Marcar a través de las capas superiores.
Crease through the top layers.

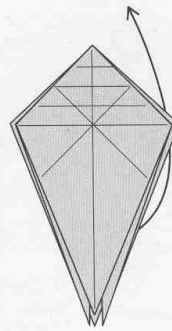

9. Levantar una punta de atrás.
Lift a point behind.



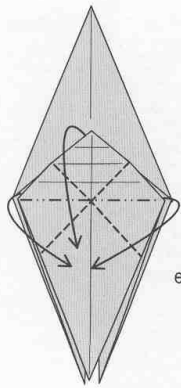

10. Doblar una especie de pliegue preliminar.
Collapse as for a preliminary fold.

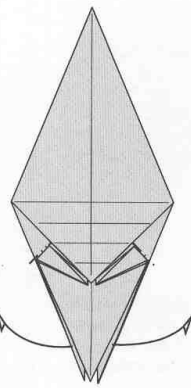

11. Doblar dos aletas en monte.
Mountain-fold two flaps.

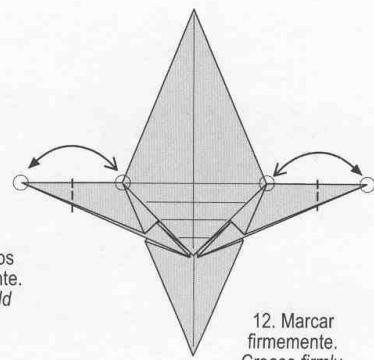

12. Marcar firmemente.
Crease firmly.

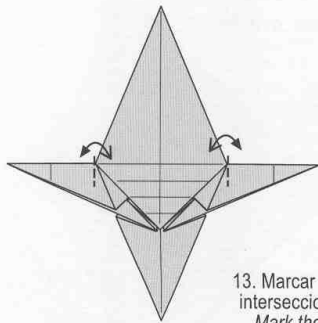

13. Marcar estas intersecciones.
Mark these intersections.

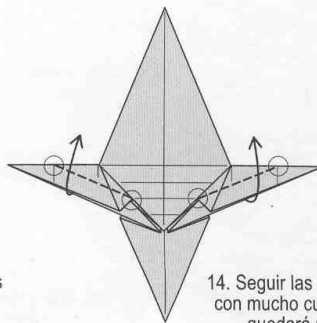

14. Seguir las referencias con mucho cuidado. No quedará plano.
Follow the references very carefully. The model will not lie flat.

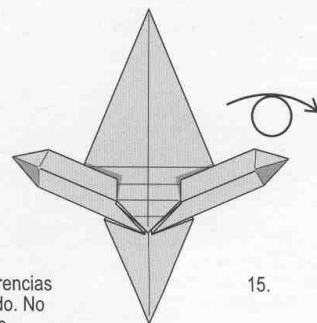

15.

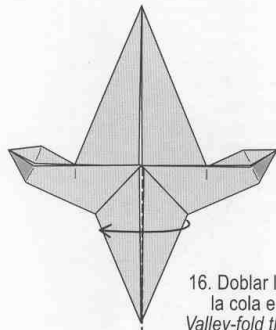

16. Doblar la aleta de la cola en valle.
Valley-fold the tail flap.

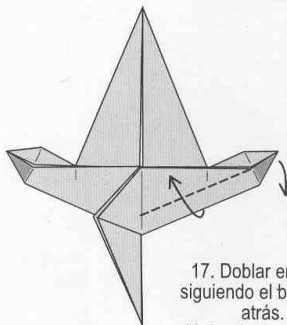

17. Doblar en valle siguiendo el borde de atrás.
Valley-fold along the edge behind.

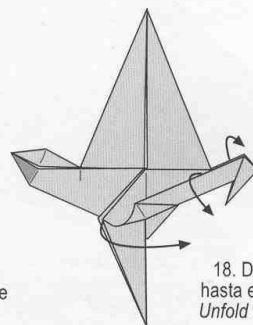

18. Desdoblar hasta el paso 14.
Unfold to step 14.

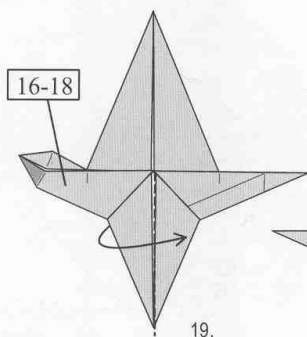

19.

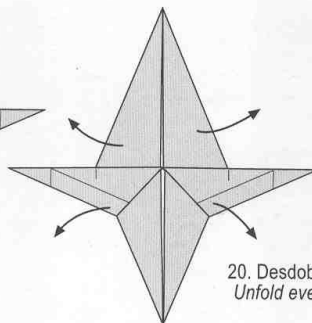

20. Desdoblar todo.
Unfold everything.

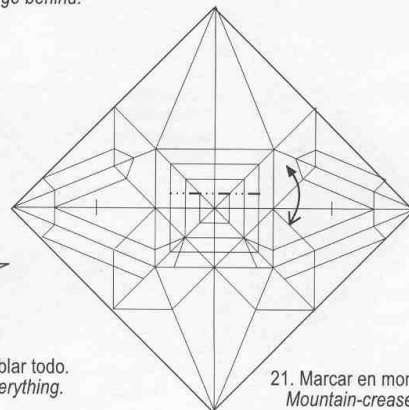

21. Marcar en monte.
Mountain-crease.



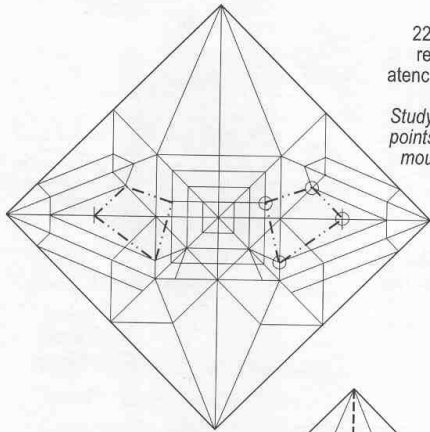

22. Observar las referencias con atención, luego marcar en monte.
Study these reference points carefully before mountain-creasing.

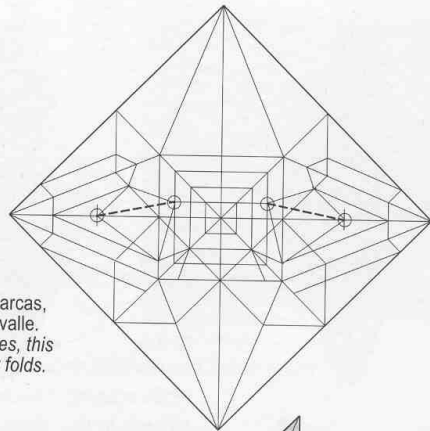

23. Más marcas, ahora en valle.
More creases, this time valley folds.

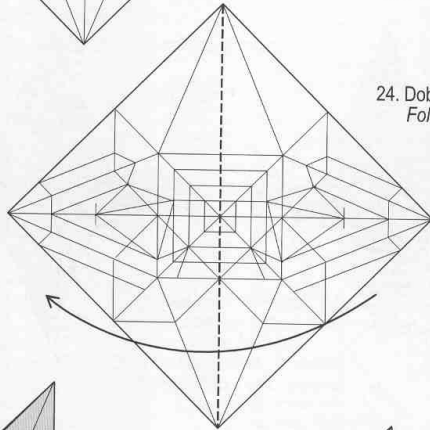

24. Doblar al medio.
Fold in half.

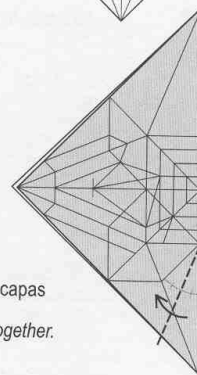

25. Doblar dos capas juntas.
Fold two layers together.

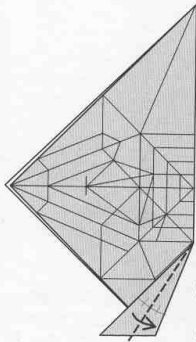

26. Doblar dos capas juntas.
Fold two layers together.

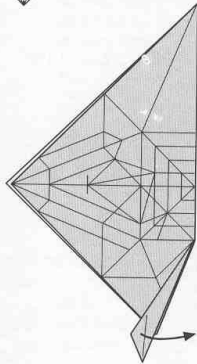

27. Desdoblar.
Unfold.

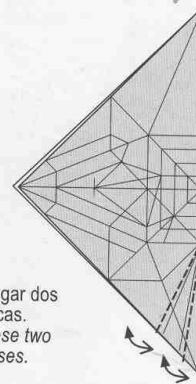

28. Agregar dos marcas.
Add these two creases.

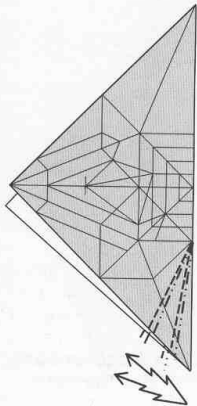

29. Escalonar para corregir la dirección de los pliegues.
Crimp-fold, correcting the direction of the folds.

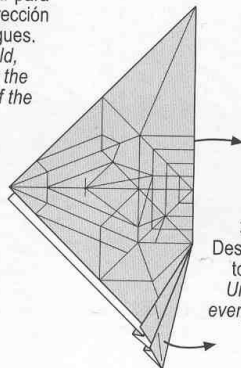

30. Desdoblar todo.
Unfold everything.

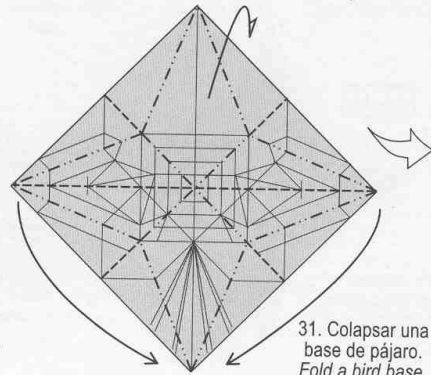

31. Colapsar una base de pájaro.
Fold a bird base.



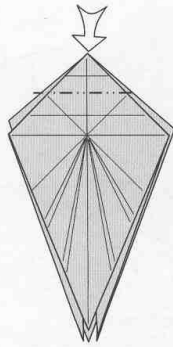

32. Hundir abierto.
Open-sink.

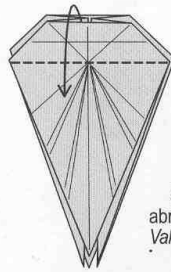

33. Doblar en valle
abriendo la parte central.
*Valley-fold, spreading the
central part.*

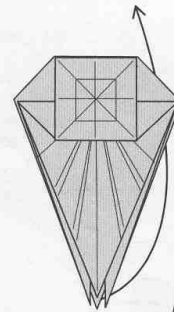

34. Levantar la
aleta de atrás.
Lift the back flap.

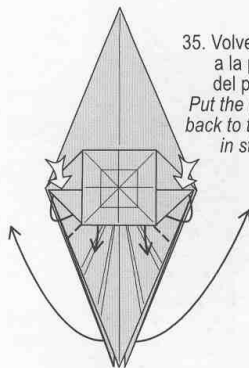

35. Volver las aletas
a la posición
del paso 12.
*Put the lower flaps
back to the position
in step 12.*

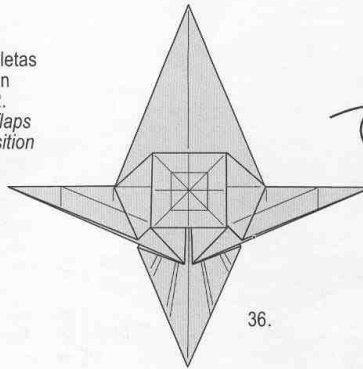

36.

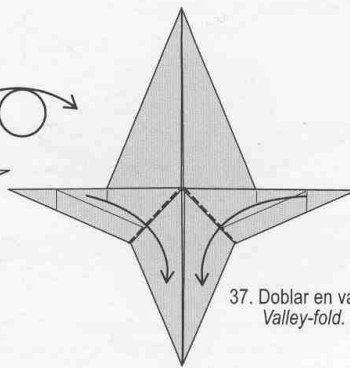

37. Doblar en valle.
Valley-fold.

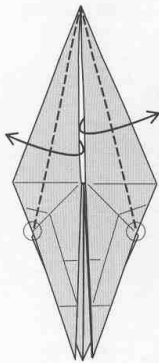

38. Estas no son
bisectrices.
No quedará plano.
*These are not
angle bisectors.
The model will not
lie flat.*

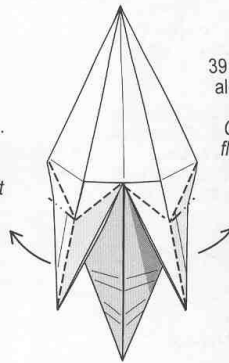

39. Colapsar estas
aletas con orejas
de conejo.
*Collapse these
flaps with rabbit
ears.*

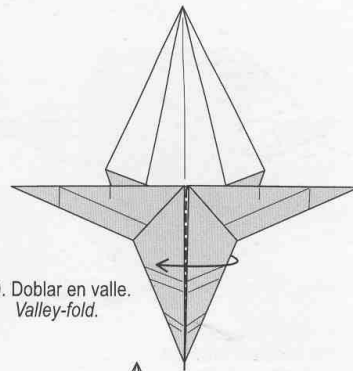

40. Doblar en valle.
Valley-fold.

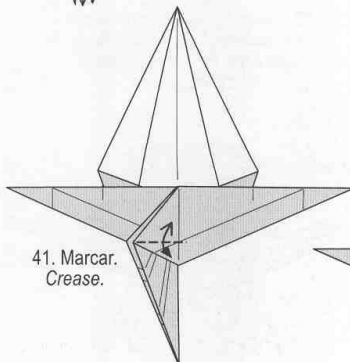

41. Marcar.
Crease.

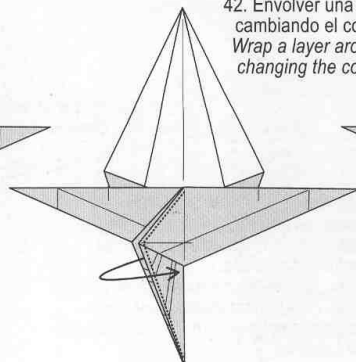

42. Envolver una capa
cambiando el color.
*Wrap a layer around
changing the color.*

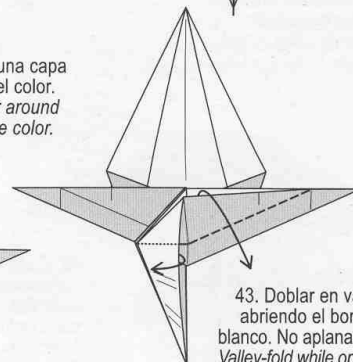

43. Doblar en valle
abriendo el borde
blanco. No aplanar aun.
*Valley-fold while opening
the white edge. Do not
flatten yet.*



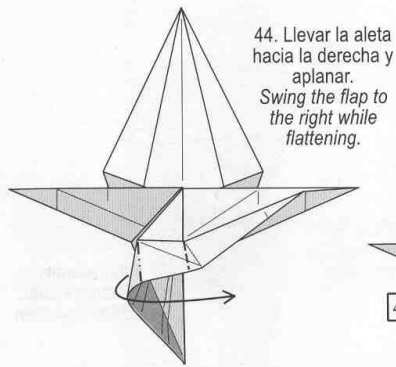

44. Llevar la aleta hacia la derecha y aplanar.
Swing the flap to the right while flattening.

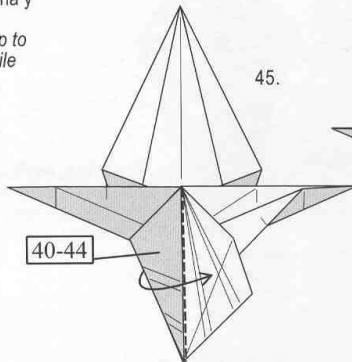

45.

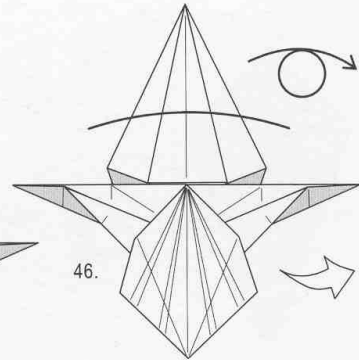

46.

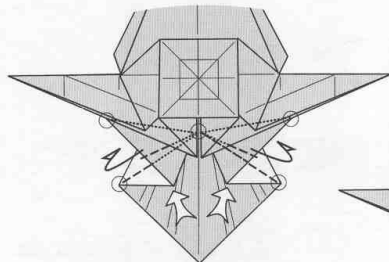

47. Revertir siguiendo las referencias.
Reverse-fold following the reference points.

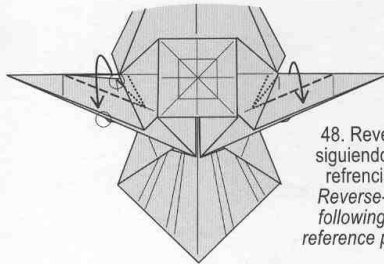

48. Revertir siguiendo las referencias.
Reverse-fold following the reference points.

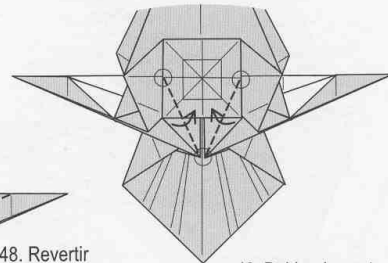

49. Doblar de punto a punto. Estas no son bisectrices.
Fold from point to point. These are not angle bisectors.

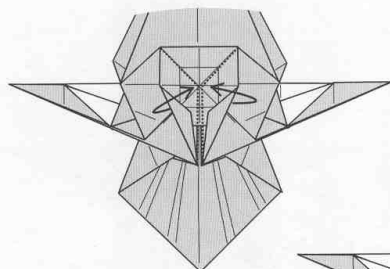

50. Pasar una capa de atrás hacia adelante con mucho cuidado.
Carefully bring a back layer to the front.

51. Doblar en valle para trabajar en el interior de las patas.
Valley-fold to work on the inside of the legs.

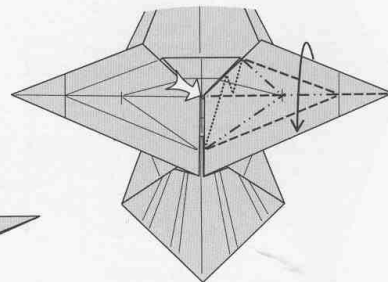
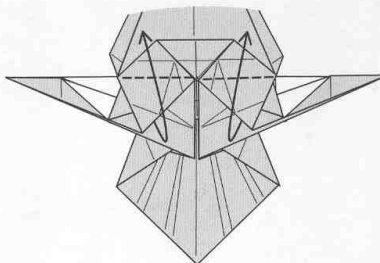

52. Cerrar la aleta incorporando los dobleces que se muestran.
Close the flap, incorporating the folds shown.

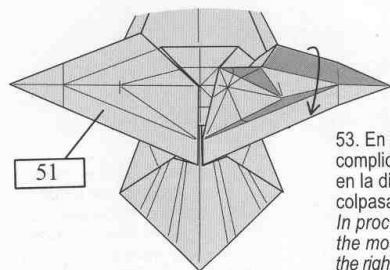

51

53. En proceso. Este es al paso más complicado del modelo. Colocar los pliegues en la dirección correcta antes de intentar colapsarlos todos juntos.
In process. This is the most difficult step of the model. Fold the creases one by one in the right direction before attempting to collapse them all together.

54. Hundir abierto.
Open-sink.

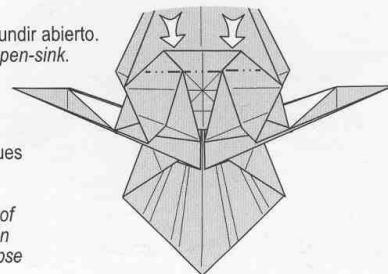

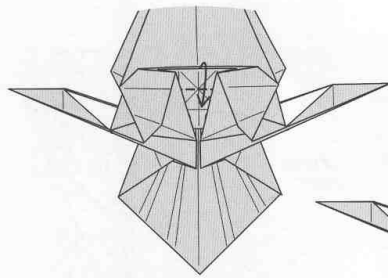

55. Doblar un borde que queda parcialmente cubierto.
Fold down one partially covered edge.

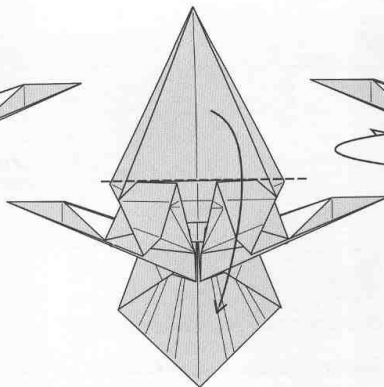

56. Doblar en valle a la altura de la altura de las alas.
Valley-fold in line with the top edge of the wings.

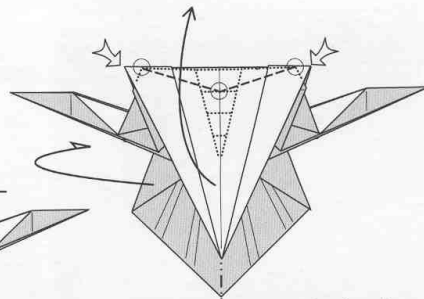

57. Doblar todo el modelo al medio mientras se levanta la cabeza según las referencias.
Fold the model in half while lifting the head using the reference points provided.

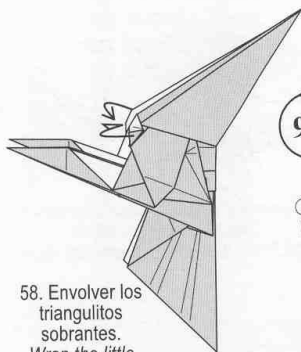

58. Envolver los triángulos sobrantes.
Wrap the little triangles inwards.

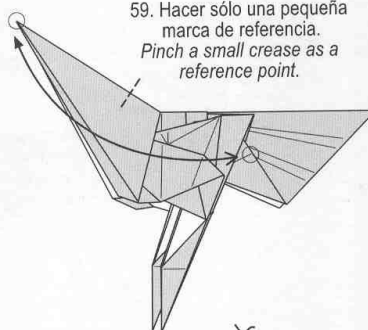

59. Hacer sólo una pequeña marca de referencia.
Pinch a small crease as a reference point.

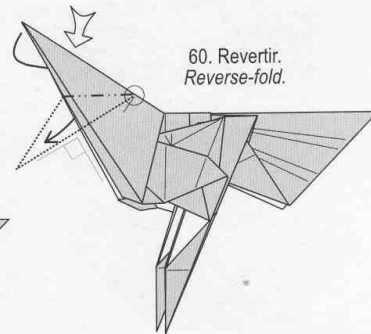

60. Revertir.
Reverse-fold.

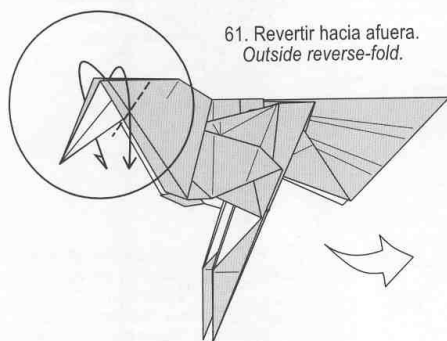

61. Revertir hacia afuera.
Outside reverse-fold.

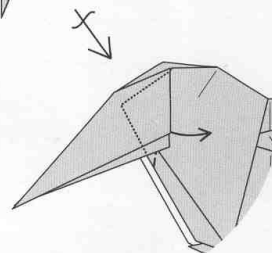

62. Deslizar papel hacia afuera.
Slide out some paper.

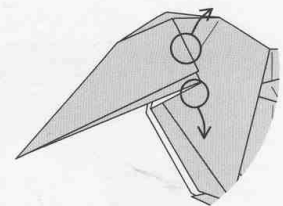

63. Con mucho cuidado desenganchar las capas.
Very carefully disengage the layers.

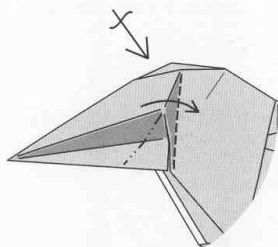

64. Aplanar sobre nuevos dobleces.
Flatten using new folds.

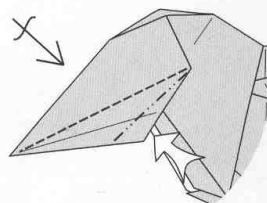

65. Pivotar a gusto afinando el pico al tiempo que cambia el color.
Swivel-fold to taste, narrowing the beak and color-changing it.

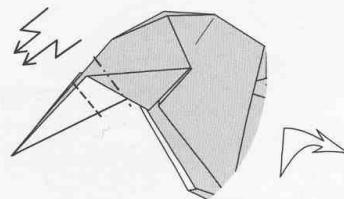

66. Escalonar a gusto.
Crimp-fold to taste.



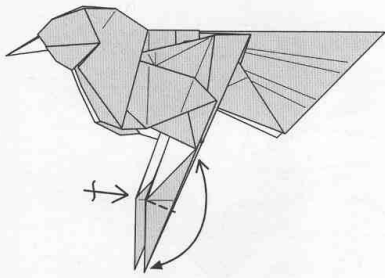

67. Marcar a través de todas las capas.
Crease through all layers.

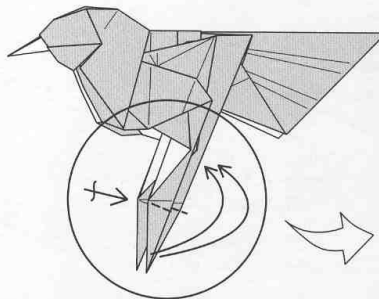

68. Revertir hacia afuera manteniendo las capas separadas.
Outside reverse-fold all layers separately.

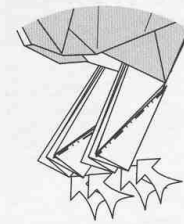

69. Revertir 4 bordes.
Reverse-fold 4 edges.

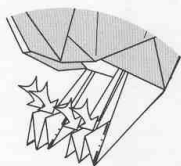

70. Revertir otros cuatro bordes...
Reverse-fold another four edges...

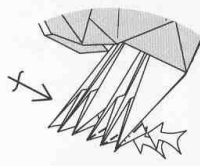

71...y cuatro más para terminar.
...and the last four.

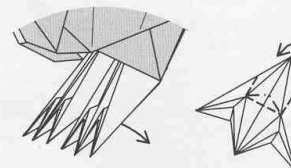

72. Levantar el cuarto dedo usando los dobleces que se muestran.
Lift the fourth claw using the creases shown.

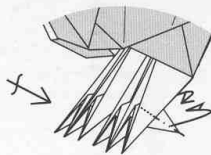

73. Afinar el dedo doblando hacia adentro.
Narrow the rear claw, folding in some paper.

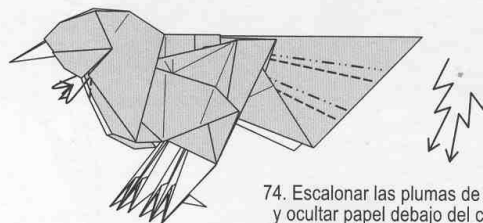

74. Escalonar las plumas de la cola y ocultar papel debajo del cuello.
Crimp-fold the tail feathers and shape the throat.

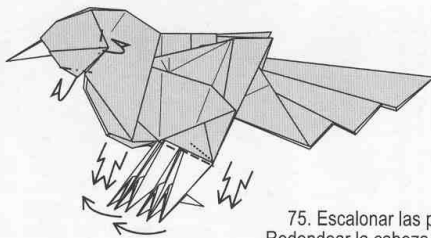

75. Escalonar las patas. Redondear la cabeza a gusto.
Crimp-fold the legs. Round the head to taste.



76. Abrir los dedos, aplanar el lomo, liberar el borde del ala y dar volumen a la cabeza.
Open out the toes, flatten the back, and open out the top of the head.

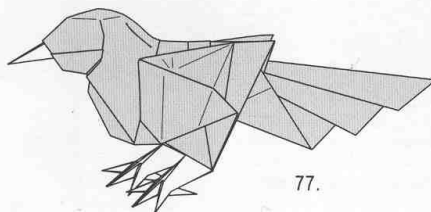

77.

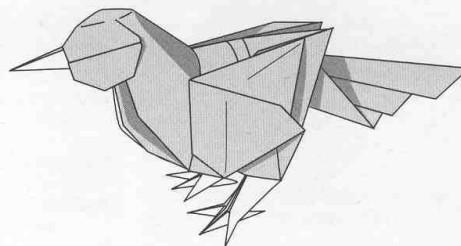

UNICORNIO

UNICORN

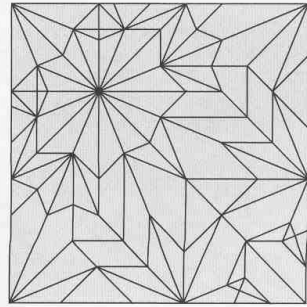
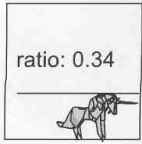
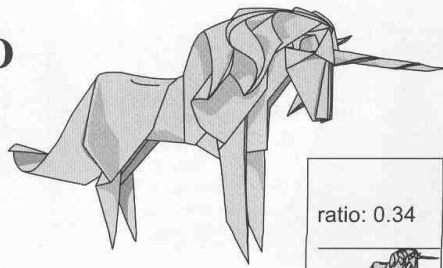

Nivel 4
 Papel favorito: Tant, Kraft u otros papeles de espesor medio a fino. El mismo color en ambas caras.
 Tamaño recomendado: 35 cm.
 Comentarios: doblar en húmedo.

Level 4
 Favorite paper: Tant, Kraft, or other medium to thin papers. Same color on both sides.
 Recommended size: 35 cm.
 Comments: wet-fold.

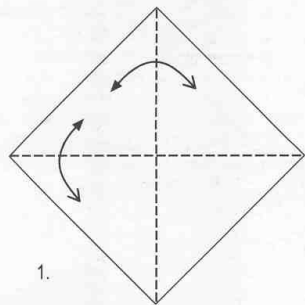

1.

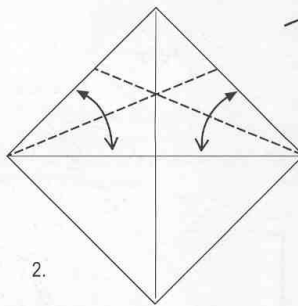

2.

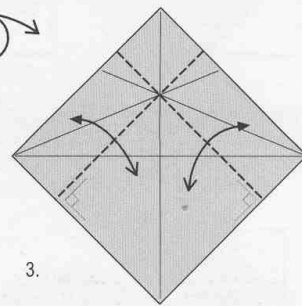

3.

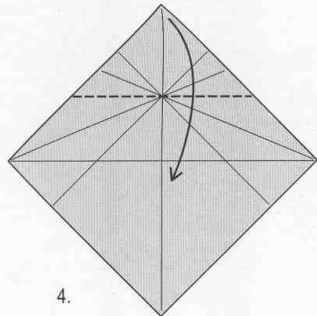

4.

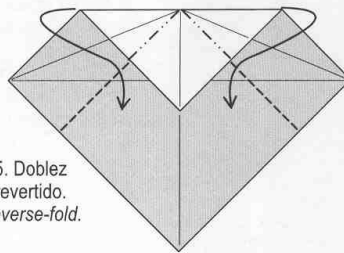

5. Doblez revertido.
Reverse-fold.

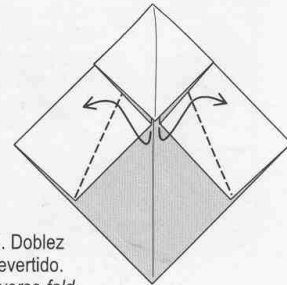

6. Doblez revertido.
Reverse-fold.

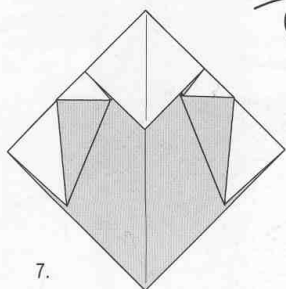

7.

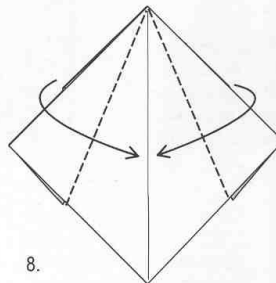

8.

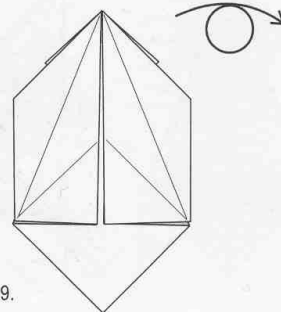

9.



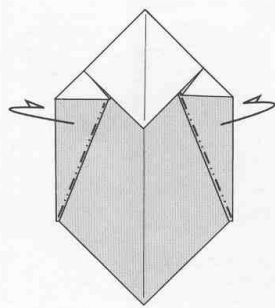

10.

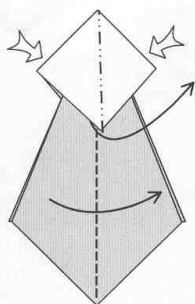

11. Doblar en valle a la mitad mientras se levanta la punta blanca.
Valley-fold in half while lifting the white flap up.

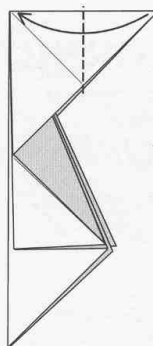

12. Doblar en valle.
Valley-fold.

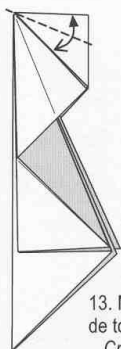

13. Marcar a través de todas las capas.
Crease through all layers.

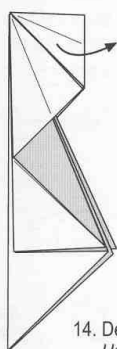

14. Desdoblar.
Unfold.

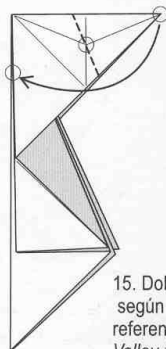

15. Doblar en valle según las referencias.
Valley-fold using the reference points.

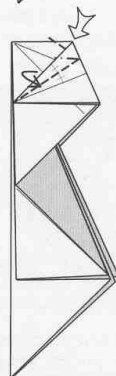

16. Doblar en valle mientras se aplasta la esquina.
Fold the angle bisector while squash-folding the corner.

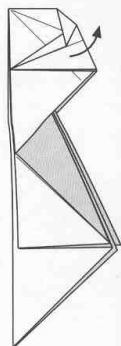

17. Desdoblar hasta el paso 15.
Unfold to step 15.

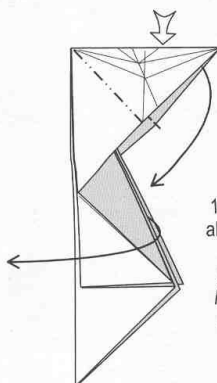

18. Abrir el modelo al medio aplastando la punta.
Fold the model in half while squash-folding the point.

19. Doblar en valle.
Valley-fold.

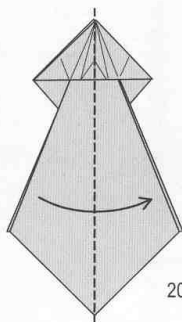
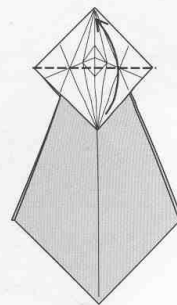

20.

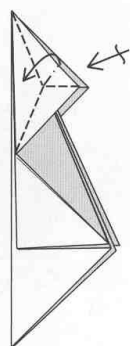

21. Doblar una oreja de conejo. Repetir atrás.
Fold a rabbit ear. Repeat behind.

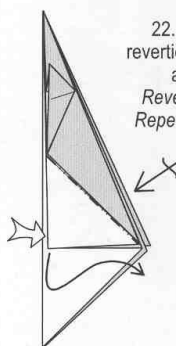

22. Doblez revertido. Repetir atrás.
Reverse-fold. Repeat behind.

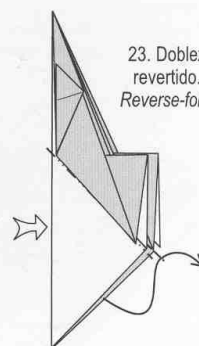

23. Doblez revertido.
Reverse-fold.



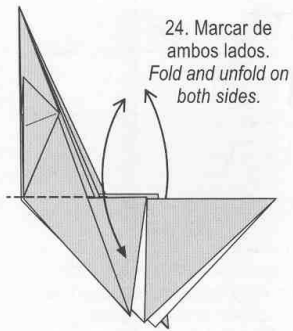

24. Marcar de ambos lados.
Fold and unfold on both sides.

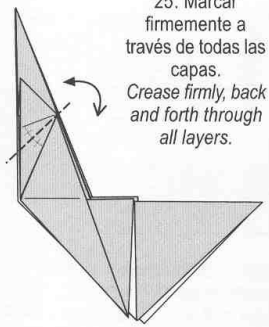

25. Marcar firmemente a través de todas las capas.
Create firmly, back and forth through all layers.

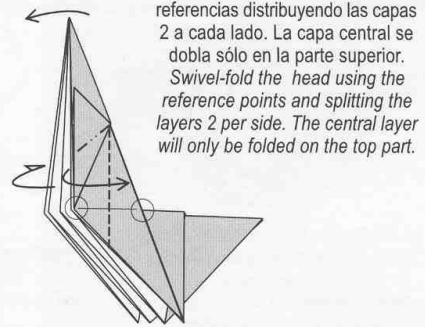

26. Pivotar la cabeza según las referencias distribuyendo las capas 2 a cada lado. La capa central se dobla sólo en la parte superior.
Swivel-fold the head using the reference points and splitting the layers 2 per side. The central layer will only be folded on the top part.

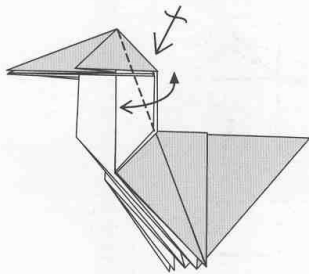

27. Marcar firmemente a través de todas las capas de un lado y repetir atrás.
Create firmly through all layers on one side and repeat behind.

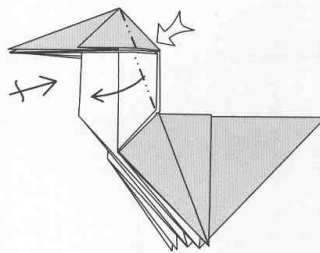

28. Deslizar las capas hacia la izquierda. Repetir atrás.
Slide the layers to the left. Repeat behind.

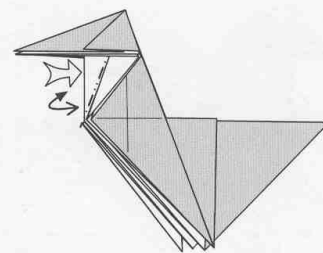

29. Marcar para luego hacer un hundido abierto. Se puede abrir el papel y acceder por detrás.
Pre-create and open-sink. It is easy to open the paper up a bit and reach in from behind.

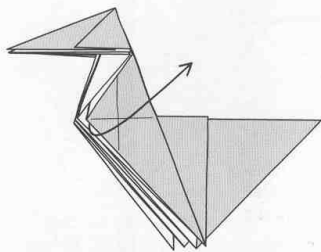

30. Levantar el primer borde.
Lift the first edge.

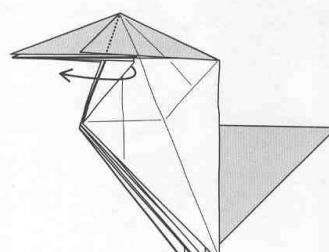

31. Doblar en valle.
Valley-fold.

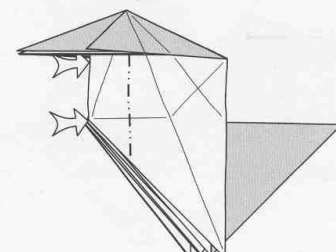

32. Hundir abierto.
Open-sink.

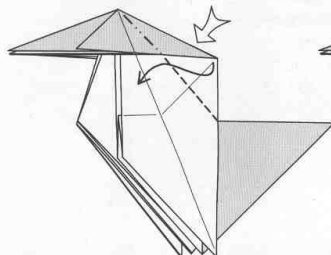

33. Revertir.
Reverse-fold.

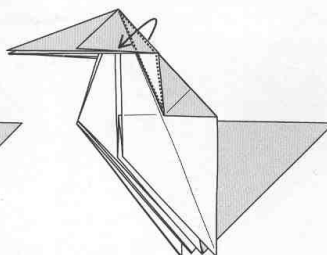

34. Envolver con la capa de atrás.
Wrap the layer behind to the front.

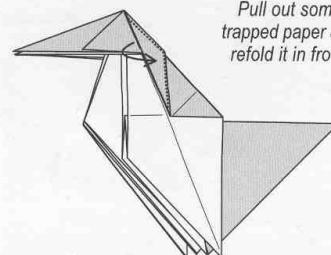

35. Sacar el papel atrapado y doblarlo adelante.
Pull out some trapped paper and refold it in front.



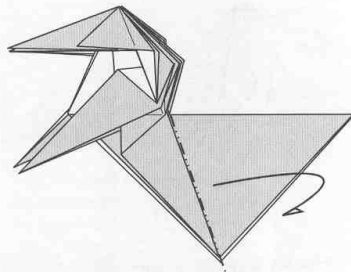

48. Doblar las dos capas juntas en monte.
Mountain-fold two layers as one.

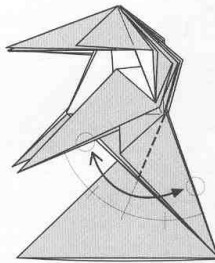

49. Marcar suavemente, es una referencia. Luego desdoblar hasta el paso 48.
Create lightly, as it is for reference only. Then unfold to step 48.

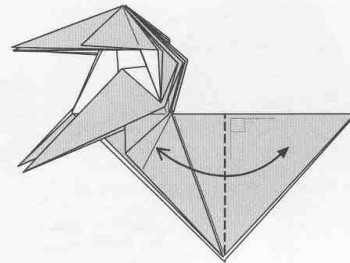

50.

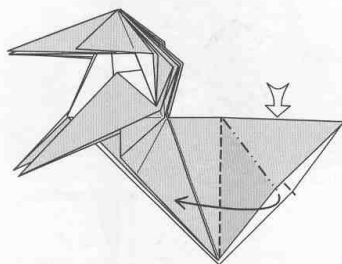

51. Abrir y aplastar.
Squash-fold.

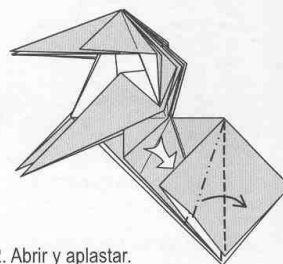

52. Abrir y aplastar.
Squash-fold.

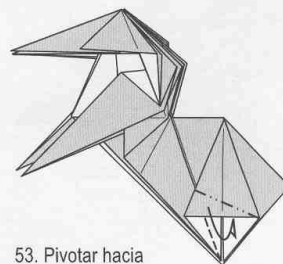

53. Pivotar hacia adentro.
Swivel-fold in.

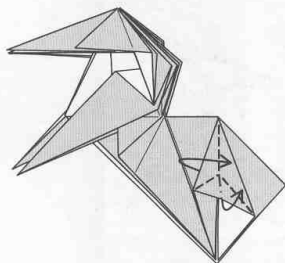

54. Cerrar la aleta incorporando un doblez revertido.
Close the flap while incorporating a reverse fold.

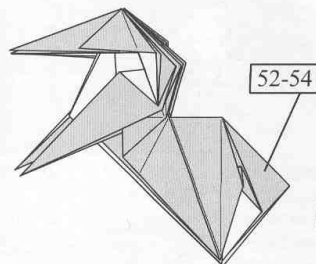

55. Repetir los pasos del otro lado.
Repeat steps on the other side.

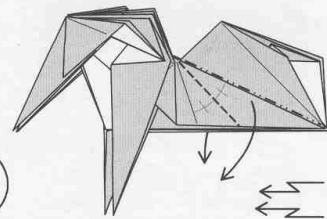

56. Hacer un doblez escalonado simétrico en las patas.
Crimp the legs.

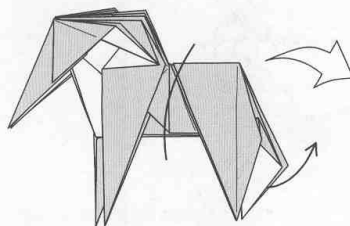

57. Revertir la cola hacia afuera.
Reverse-fold the tail out.

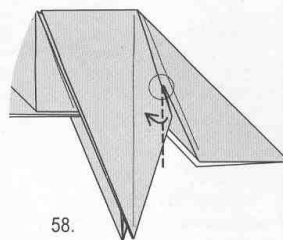

58.

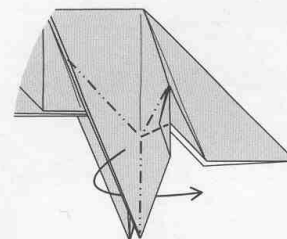

59. Hacer una oreja de conejo. Observar la posición de los dobleces.
Rabbit-ear the leg. Note the position of the folds.



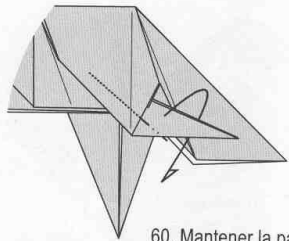

60. Mantener la pata lo más larga que se pueda.
Keep the leg as long as possible.

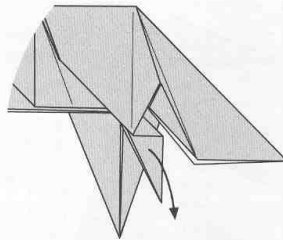

61. Desdoblar hasta el paso 59.
Unfold to step 59.

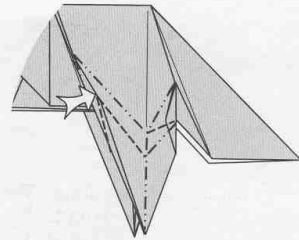

62. Re-doblar sobre las mismas marcas, haciendo una doble oreja de conejo del lado izquierdo.
Refold using the same creases, making a double-rabbit ear on the left side.

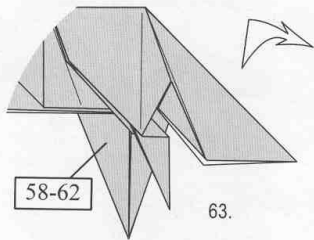

63.

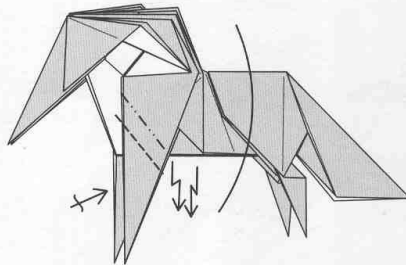

64. Escalonar las patas delanteras.
Crimp the legs.

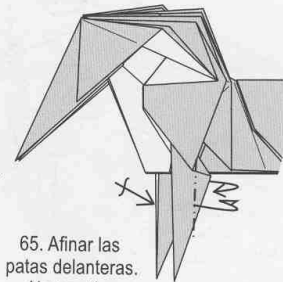

65. Afinar las patas delanteras.
Narrow the front legs.

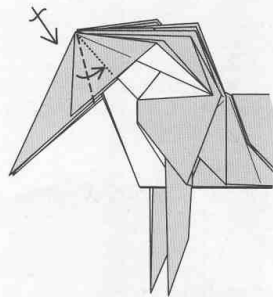

66. Doblar las orejas en valle. La referencia es un borde oculto.
Valley-fold the ears. The reference is a hidden edge.

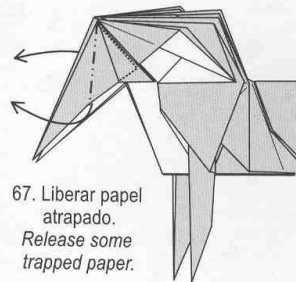

67. Liberar papel atrapado.
Release some trapped paper.

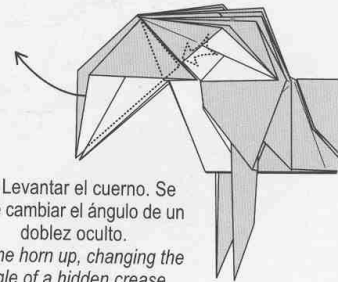

68. Levantar el cuerno. Se debe cambiar el ángulo de un doblez oculto.
Lift the horn up, changing the angle of a hidden crease.

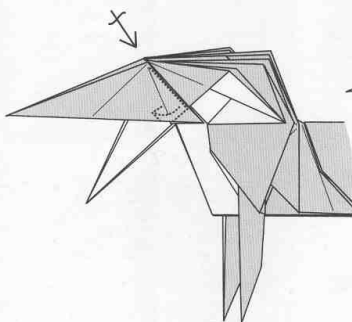

69. Hacer un pequeño doblez revertido en el borde blanco oculto.
Reverse-fold a small hidden white edge.

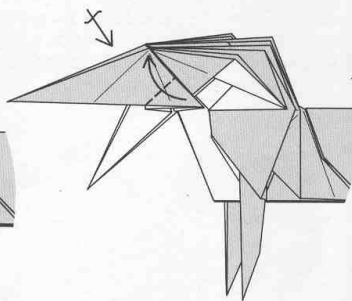

70. Doblar las orejas en valle aplastando un borde debajo.
Valley-fold the ears squashing an edge underneath.

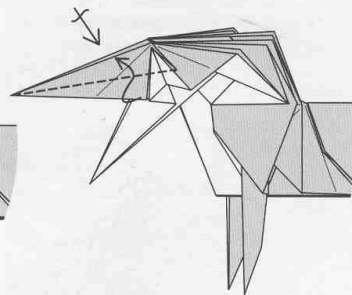

71. Doblar una capa del cuerno a cada lado. Se debe hacer un pequeño doblez revertido detrás de las orejas.
Valley-fold one layer on each side of the horn. Make a little reverse fold behind the ears.



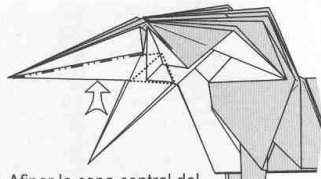

72. Afinar la capa central del cuerno haciendo un acodo oculto. Se usan las marcas del paso 16. *Narrow the central layer of the horn making a hidden gusset. Use the creases formed in step 16.*

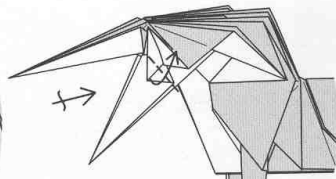

73. Doblar las mejillas en valle. *Valley fold the cheeks.*

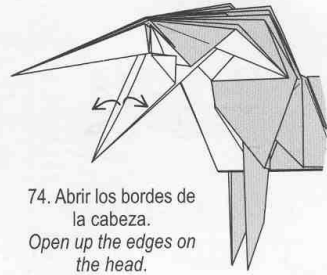

74. Abrir los bordes de la cabeza. *Open up the edges on the head.*



75. Doblar la punta a la mitad de manera que quede oculta por debajo de la cabeza. *Fold the point in half so it is hidden under the head.*

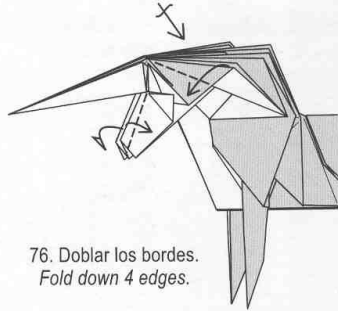

76. Doblar los bordes. *Fold down 4 edges.*



77. Sacar la punta formando una barba. *Fold the point out to form a goatee.*

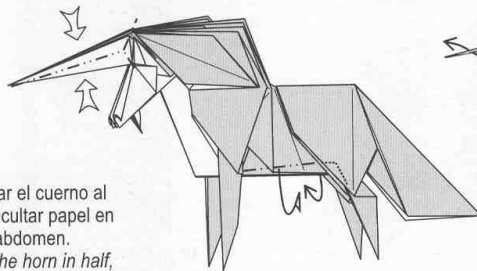

78. Afinar el cuerno al medio. Ocultar papel en el abdomen. *Narrow the horn in half, hide paper in the belly.*

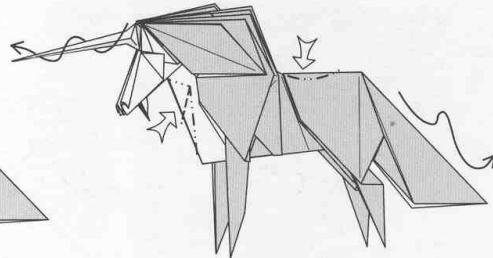

79. Más detalles de terminación. *More finishing details.*

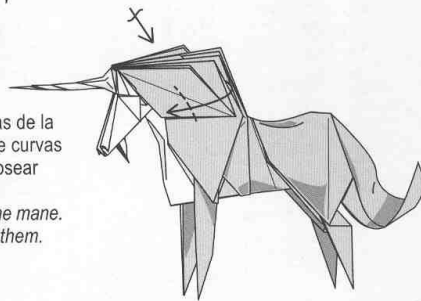

80. Curvar las capas de la crin. Hacer un par de curvas simples, no manosear demasiado. *Curve the layers of the mane. Do not over-work them.*

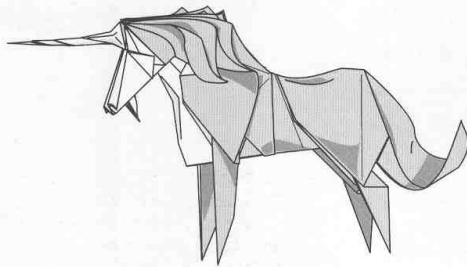

81.

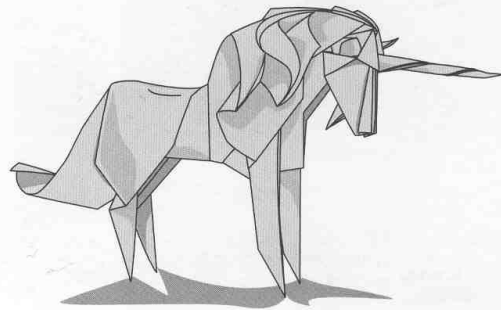

NOVILLO HEREFORD

HEREFORD STEER

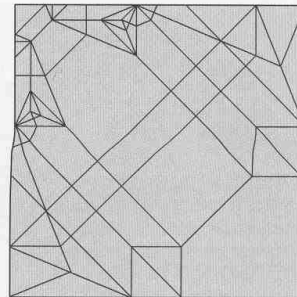
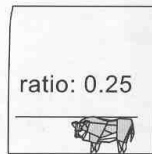
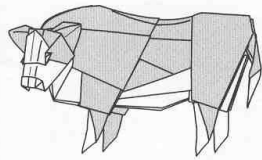

Nivel 4

Papel favorito: papel Elefante de color rojo, pintado de blanco en una de sus caras.
Tamaño recomendado: 40 cm.
Comentarios: doblar en húmedo.

Level 4

Favorite paper: red Elephant Hide paper, painted white on one side.
Recommended size: 40 cm.
Comments: wet-fold.

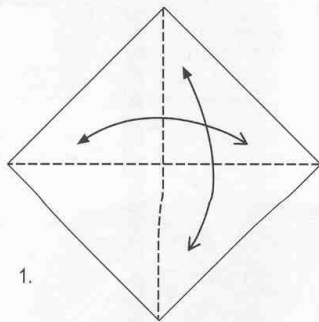

1.

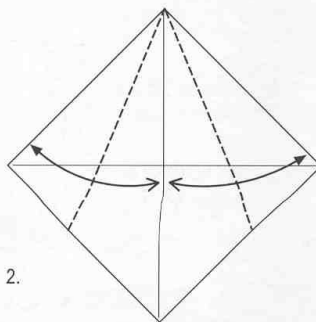

2.

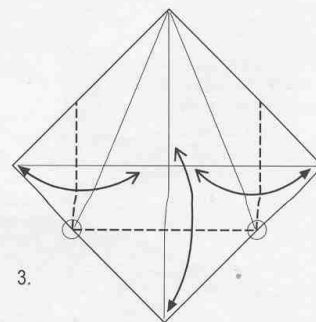

3.

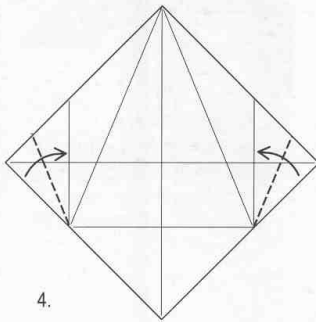

4.

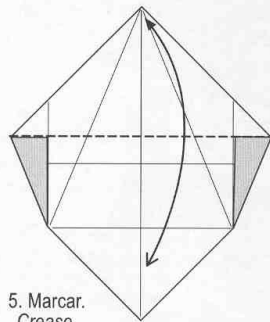

5. Marcar.
Crease.

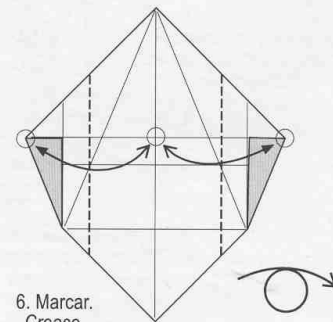

6. Marcar.
Crease.

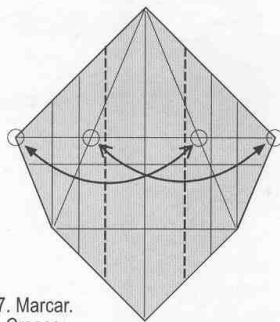

7. Marcar.
Crease.

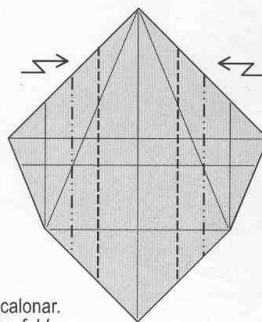

8. Escalonar.
Crimp-fold.

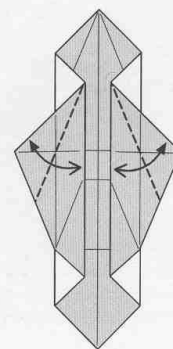

9. Marcar.
Crease.



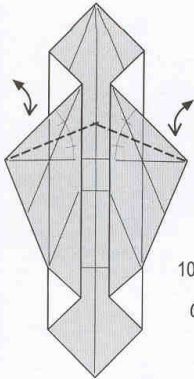

10. Marcar a través de todas las capas.
Crease through all layers.

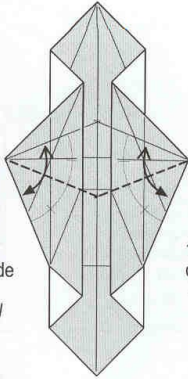

11. Marcar a través de todas las capas.
Crease through all layers.

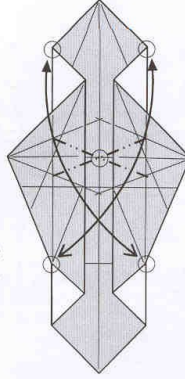

12. Marcar en monte siguiendo las referencias con cuidado.
Mountain-fold carefully, following the references.

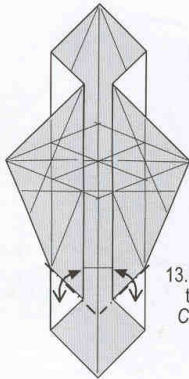

13. Marcar a través de todas las capas.
Crease through all layers.

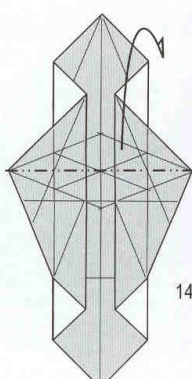

14. Doblar en monte.
Mountain-fold.

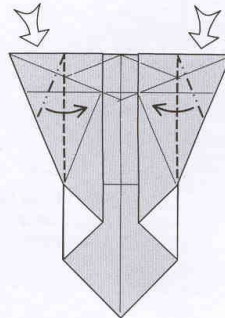

15. Abrir y aplastar.
Squash-fold.

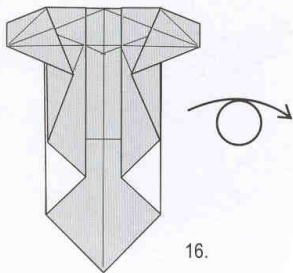

16.

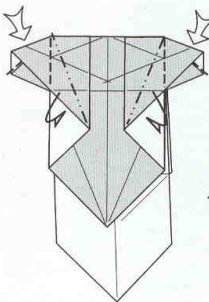

17. Pivotar emparejando los bordes.
Swivel-fold, aligning the edges at the top.

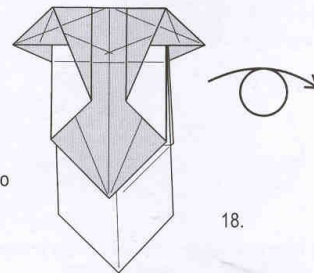

18.

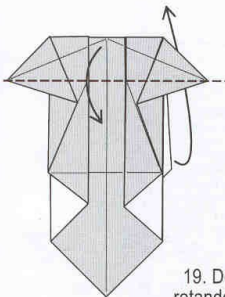

19. Doblar en valle rotando toda la aleta.
Valley-fold allowing the rear flap to flip up.

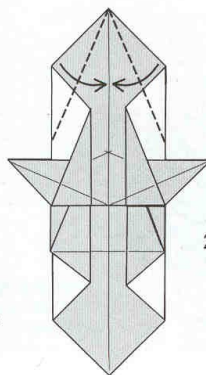

20. Doblar en valle.
Valley-fold.

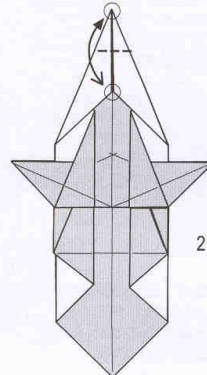

21. Marcar.
Crease.



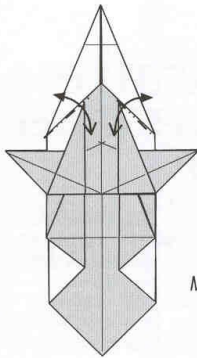

22. Marcar en monte.
Mountain-crease.

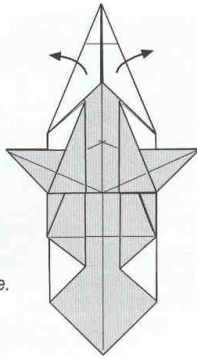

23. Desdoblar hasta el paso 20.
Unfold to step 20.

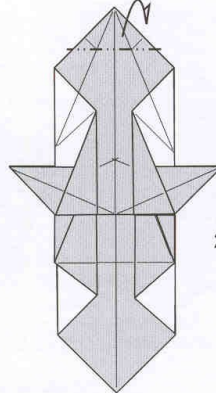

24. Doblar en monte.
Mountain-fold.

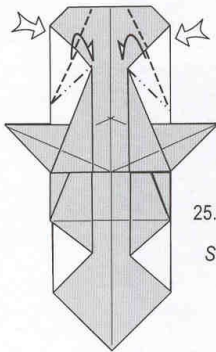

25. Pivotar hacia adentro.
Swivel-fold in.

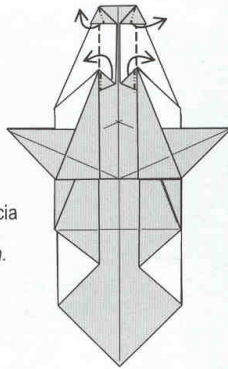

26. Deslizar papel arriba y hacer un dobléz revertido abajo.
Slide some paper out at the top while reverse-folding at the bottom.

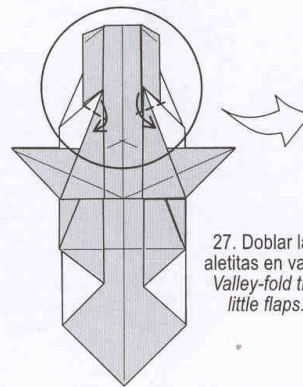

27. Doblar las aletitas en valle.
Valley-fold the little flaps.

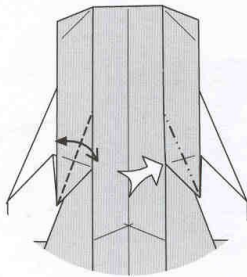

28. Marcar todas las capas de arriba y luego hundir abierto las esquinas.
Crease through all top layers and then open-sink the little corners.

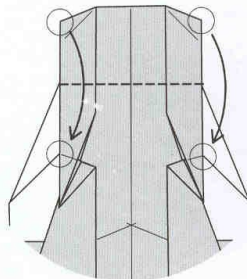

29. Doblar en valle.
Valley-fold.

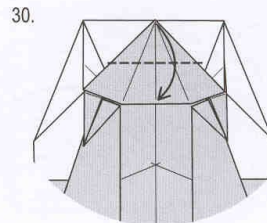

30. Doblar en valle.
Valley-fold.

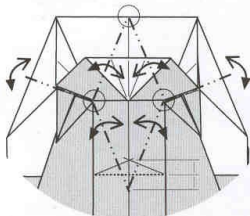

31. Marcar estos 6 pliegues en monte a través de todas las capas.
Crease these 6 mountain folds through all layers.

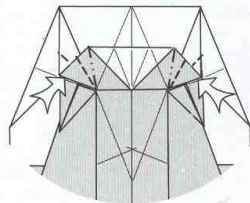

32. Pivotar.
Swivel-fold.

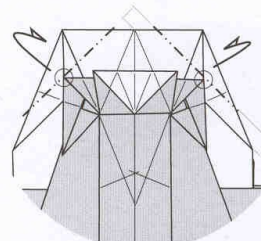

33. Estos dobleces tocan la zona de color y además son paralelos al borde que se muestra.
These folds touch the colored zone and are parallel to the indicated edge.



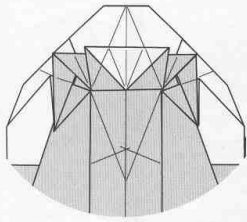

34.

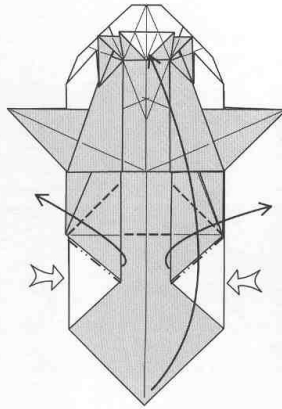

35. Abrir una gran zona del papel.
Open a large flap.

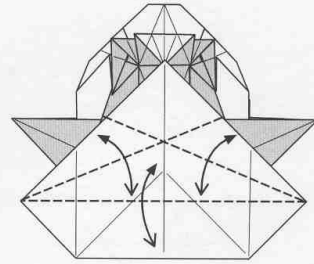

36. Marcar estas líneas.
Crease these lines.

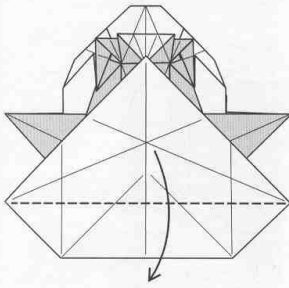

37. Doblar en valle.
Valley-fold.

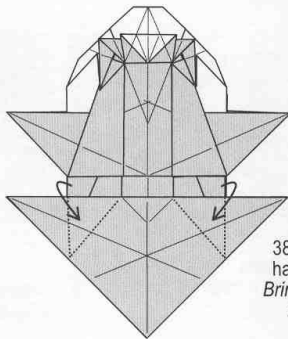

38. Traer papel hacia adelante.
Bring some paper to the front.

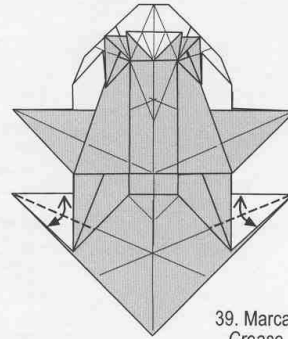

39. Marcar.
Crease.

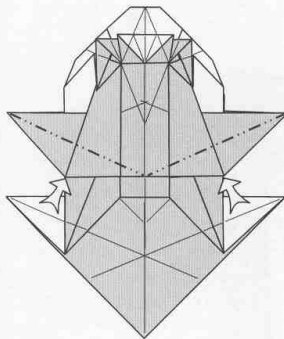

40. Hundir cerrado.
Closed-sink.

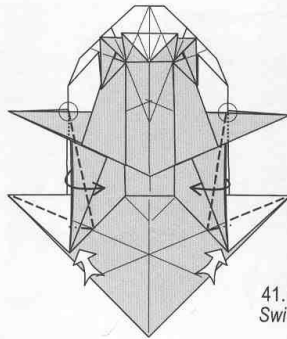

41. Pivotar.
Swivel-fold.

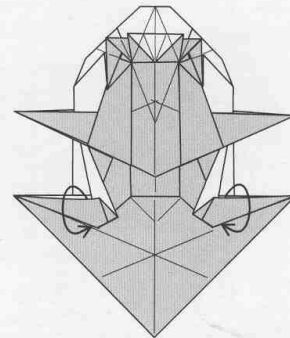

42. Envolver con una capa cambiando el color.
Wrap one layer around, changing the color.

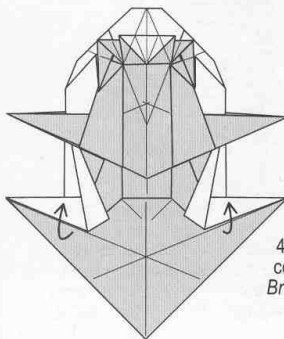

43. Traer la capa de color hacia adelante.
Bring the colored layer to the front.

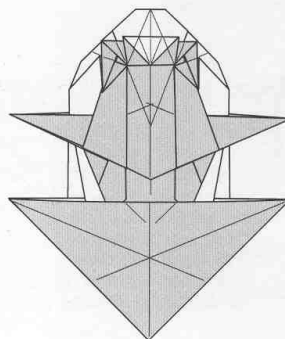

44.



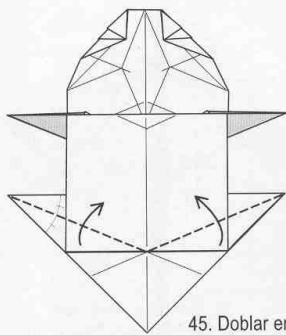

45. Doblar en valle.
Valley-fold.

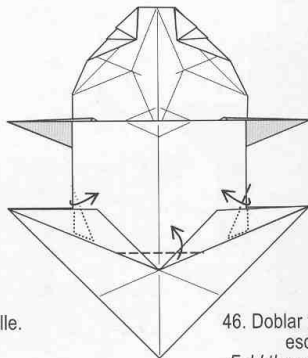

46. Doblar tres pequeñas
esquinas.
Fold three little corners.

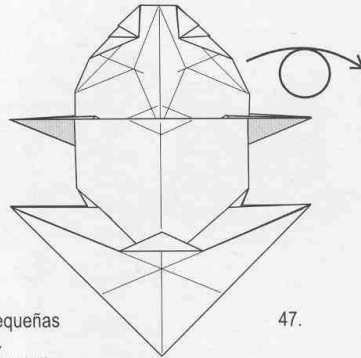

47.

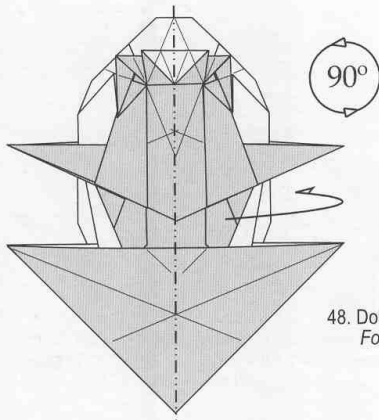

48. Doblar al medio.
Fold in half.

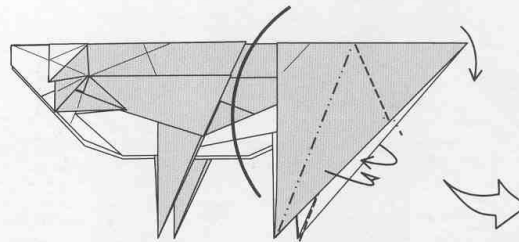

49. Pivotar la cola entre las patas.
Swivel the tail in between the legs.

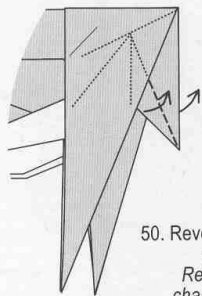

50. Revertir cambiando
el color.
Reverse-fold
changing color.

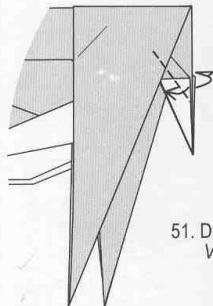

51. Doblar en valle.
Valley-fold.

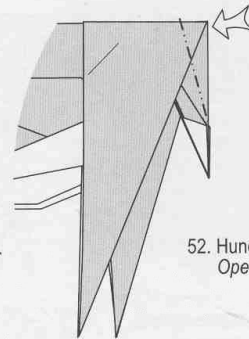

52. Hundir abierto.
Open-sink.

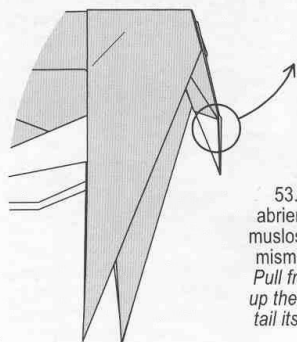

53. Tirar de la cola
abriendo la zona de los
muslos. Notar que la cola
misma no se despliega.
Pull from the tail to open
up the rear legs. Note the
tail itself is not unfolded.

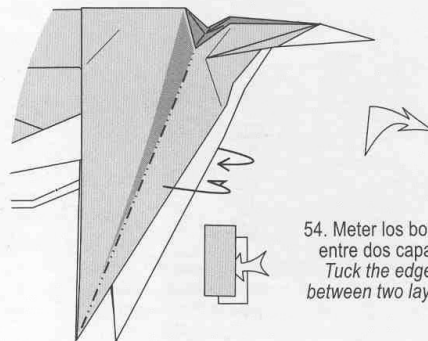

54. Meter los bordes
entre dos capas.
Tuck the edges
between two layers.



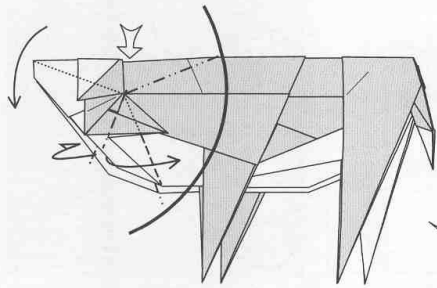

55. Rotar la cabeza usando marcas del paso 31.
Rotate the head using creases from step 31.

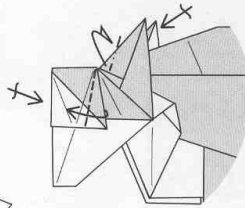

56. Adelgazar las orejas, doblar la ceja en valle.
Narrow the ears, valley-fold the eyebrows.

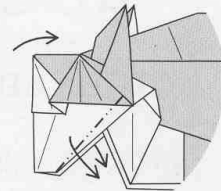

57. Acomodar la cabeza contra el cuello deslizando algunos dobleces.
Adjust the head against the neck sliding some folds into place.

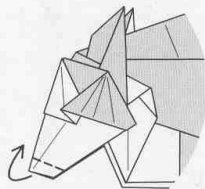

58. Revertir el papel del hocico hacia afuera.
Outside reverse-fold some paper at the nose.

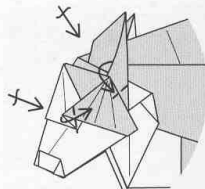

59. Formar los ojos, abrir las orejas.
Shape the eyes and ears.

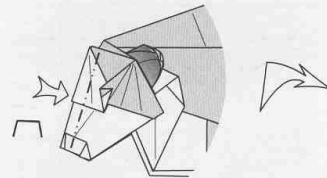

60. Dar a la cabeza una sección cuadrada con pliegues bien definidos.
Give the head a square cross section with well defined folds.

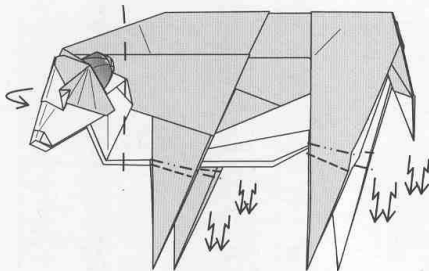

61. Escalonar las patas a gusto. Curvar el cuello un poco.
Crimp the legs to taste. Curve the neck slightly.

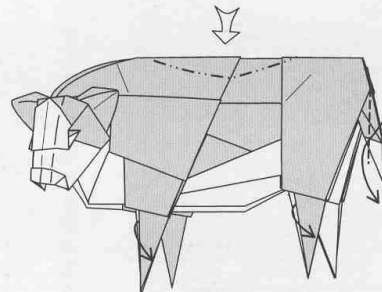

62. Deslizar un poco de papel atrapado en cada pata para mostrar una zona de color blanco. Ondular la cola. Aplanar el lomo.
Slide some paper trapped in the legs to show some white color. Curve the tail. Flatten the back.

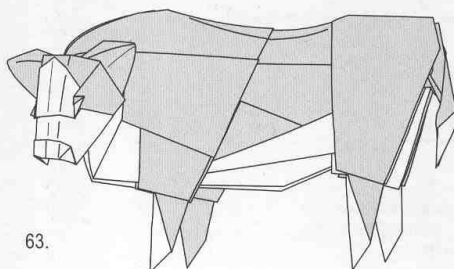

63.



ROC

AGUILA MITOLOGICA

MYTHOLOGICAL

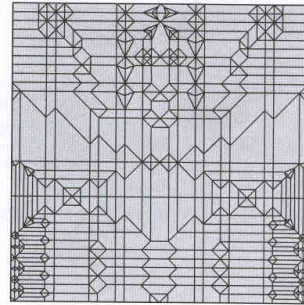
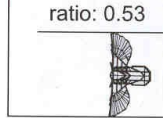
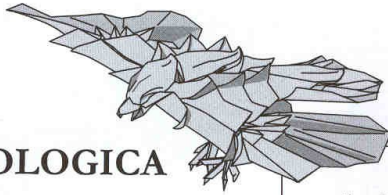

Nivel 5

Papel favorito: Elefante.

Tamaño recomendado: 50 cm o más.

Comentarios: doblar en seco. Las terminaciones se pueden dar en húmedo o con Metil Celulosa.

Level 5

Favorite paper: Elephant Hide paper.

Recommended size: 50 cm or more.

Comments: dry-fold. Use Methyl Celulose or plain water for the finishing touches.

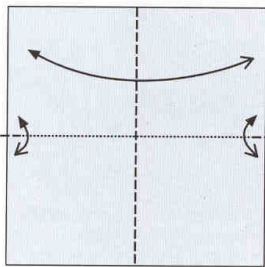

1.

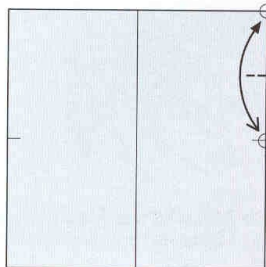

2.

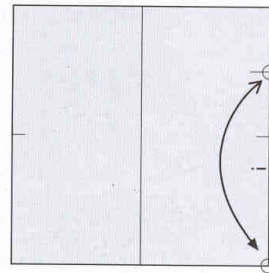

3.

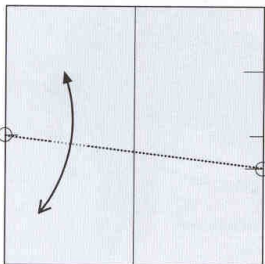

4. Marcar sólo lo necesario.
Crease only as much as is needed.

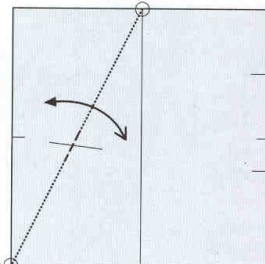

5. Marcar sólo la intersección.
Crease only the intersection.

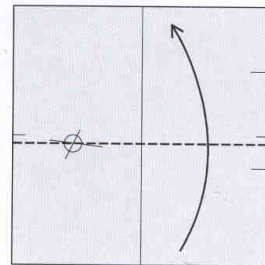

6. Doblar en valle.
Valley-fold.

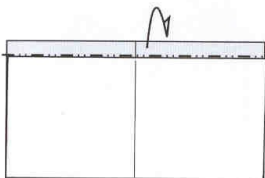

7. Doblar en monte.
Mountain-fold.

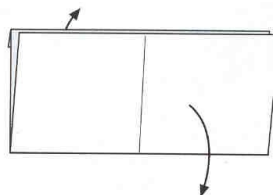

8. Desdoblar todo.
Unfold everything.

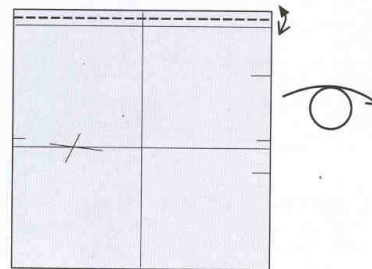

9. Marcar.
Crease.



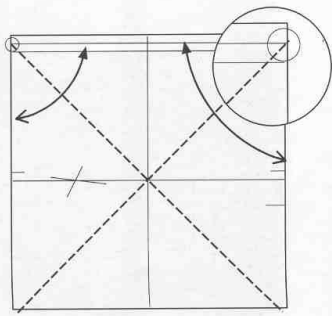

10. Marcar.
Crease.

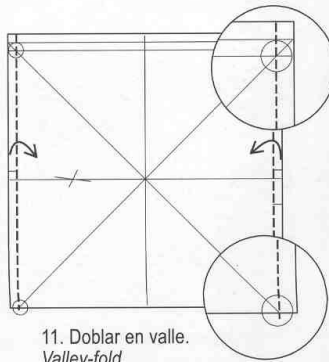

11. Doblar en valle.
Valley-fold.

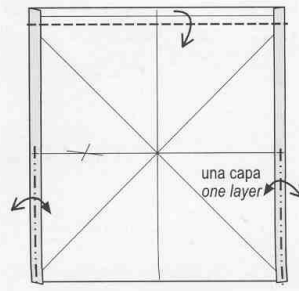

12. Marcar en monte sólo una capa.
Arriba, doblar en valle.
Mountain-crease one layer only.
Valley-fold the top.

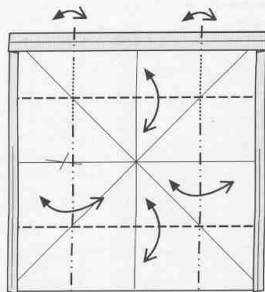

13. Marcar. Notar que las marcas
verticales son en monte y discontinuas.
Crease. Note the vertical creases are
mountain folds and are not complete.

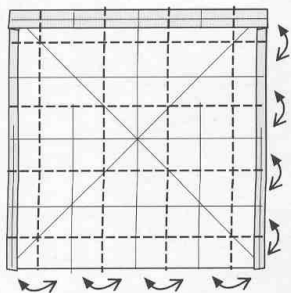

14. Marcar.
Crease.

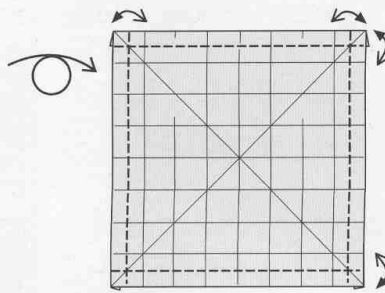

15. Marcar.
Crease.

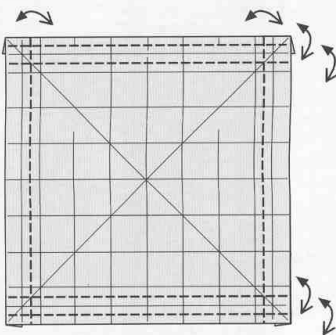

16. Marcar.
Crease.

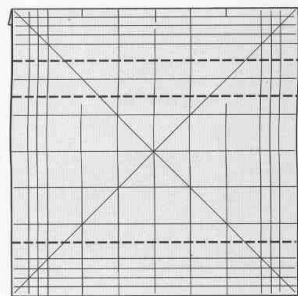

17. Marcar.
Crease.

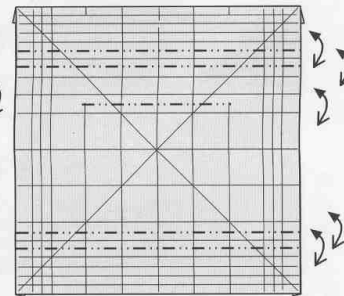

18. Marcar en monte.
Mountain crease.

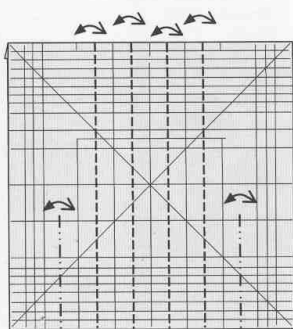

19. Marcar. Notar que algunos son
pliegues en monte.
Crease. Note some are mountain folds.

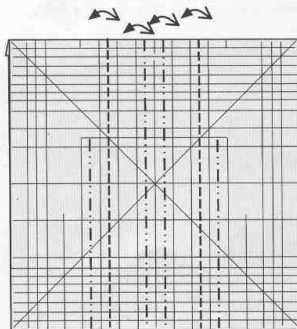

20. Marcar. Notar que algunos son
pliegues en valle.
Crease. Note some are valley folds.

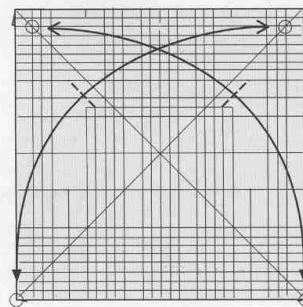

21. Marcar.
Crease.

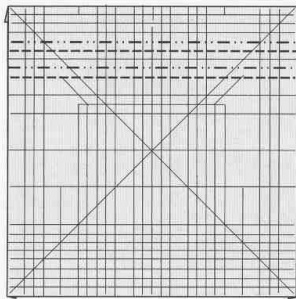

22. Escalonar.
Pleat-fold.

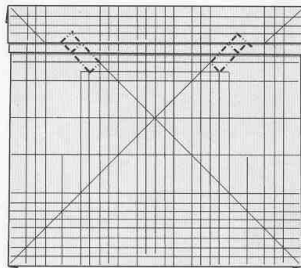

23. Marcar firmemente a través de todas las capas.
Crease firmly through all layers.

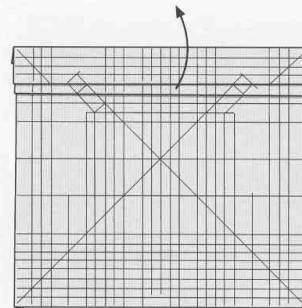

24. Desdoblar hasta el paso 22.
Unfold to step 22.

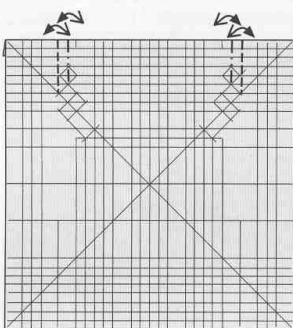

25. Marcar.
Crease.

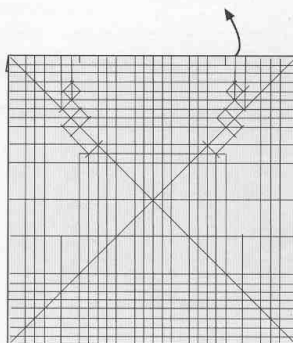

26. Desdoblar.
Unfold.

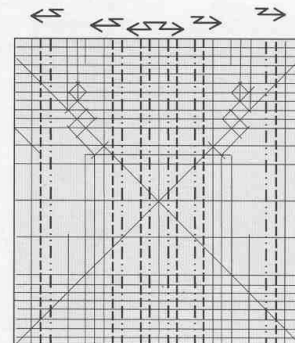

27. Escalonar.
Pleat-fold.

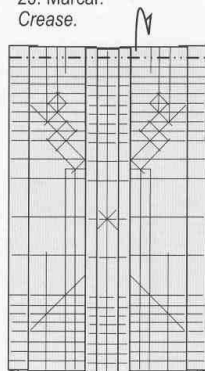

28. Doblar un segmento en monte.
Mountain-fold the top segment.

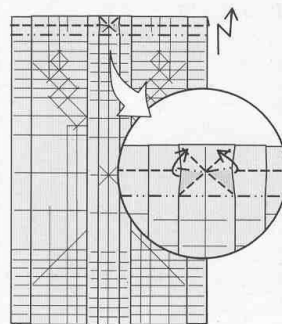

29. Escalonar incorporando dobleces revertidos.
Pleat-fold incorporating these reverse folds.

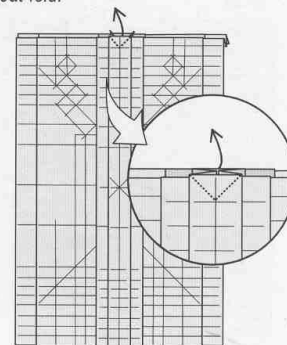

30. Sacar una punta de adentro.
Un-sink a point.

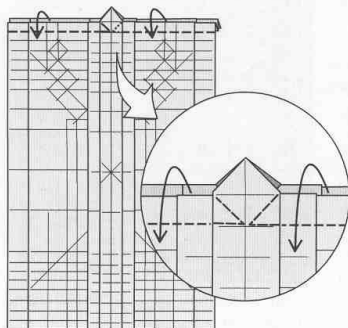

31. Doblar un borde en valle liberando el papel en la parte central con cuidado.
Valley fold one edge by carefully releasing some paper in the central part.

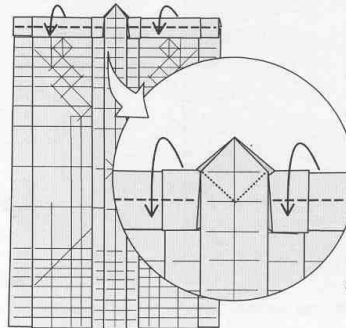

32. Repetir la maniobra en el siguiente borde.
Repeat on the next edge.

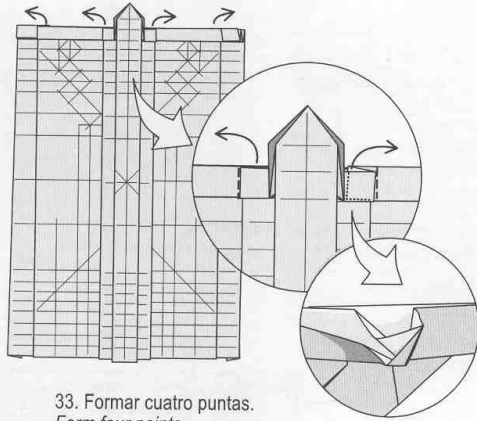

33. Formar cuatro puntas.
Form four points.

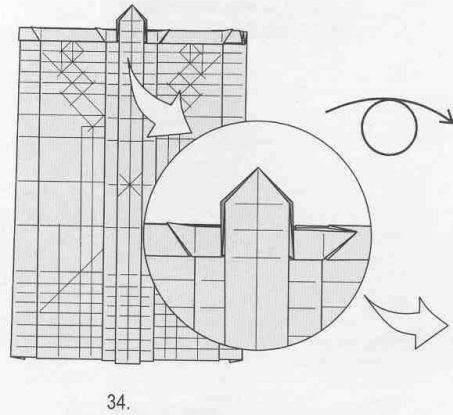

34.

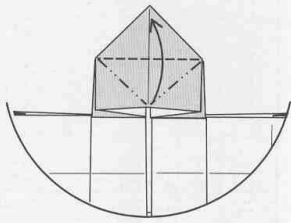

35. Doblar en pétalo.
Petal-fold.

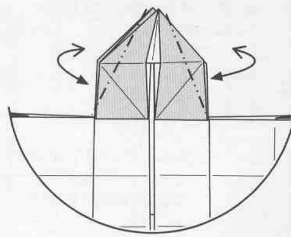

36. Marcar a través de todas las capas.
Crease through all layers.

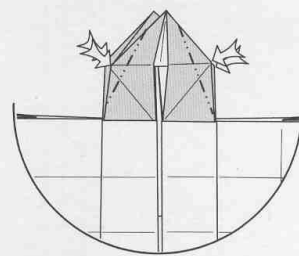

37. Hundir abierto en cuatro bordes.
Open-sink on four edges.

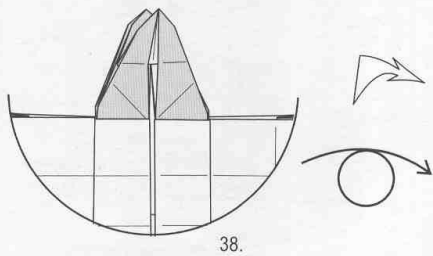

38.

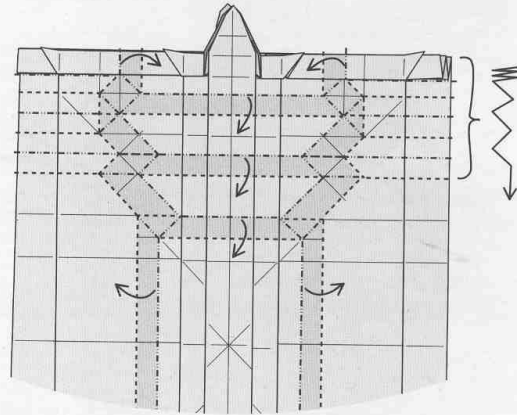

39. Este es el colapsado principal del modelo. Identificar tres escalones horizontales y dos verticales. También ayuda saber que hay que formar un acordeón "monte-valle" con los 10 primeros segmentos horizontales.

This is the main collapse of this model. Identify three horizontal and two vertical pleats. I also find it useful to know that the top 10 segments will be stacked up with mountain-valley pleats.

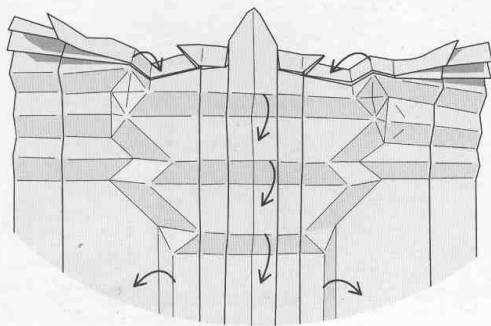

40. Identificar estas dos zonas.
Identify these two areas.

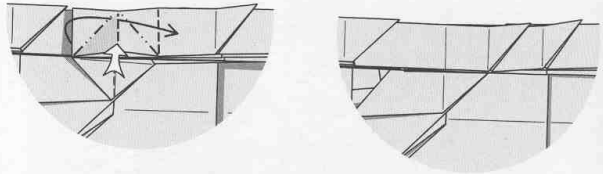
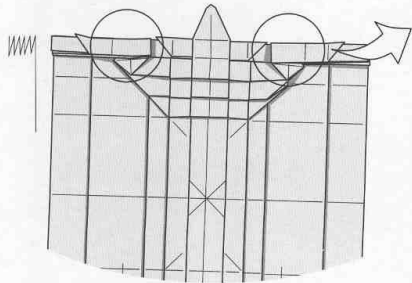

41. Formar una punta de cada lado, con la primera capa.
Form a point on each side, using the top layer.

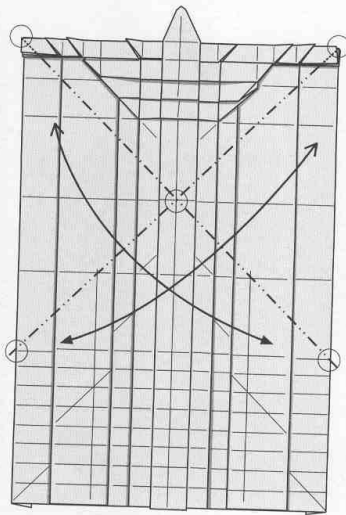

42. Marcar sin deshacer los escalones.
Crease keeping the pleats folded.

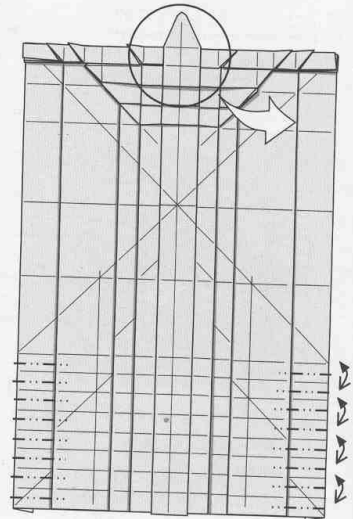

43. Marcar 16 veces.
Crease these 16 mountain folds.

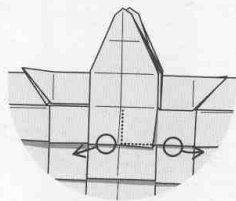

44. Separar las capas con cuidado.
Carefully pull the layers apart.

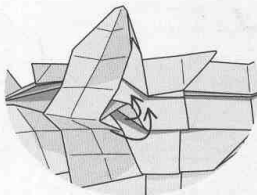

45. Paso intermedio.
Intermediate step.

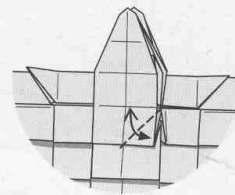

46. Marcar.
Crease.

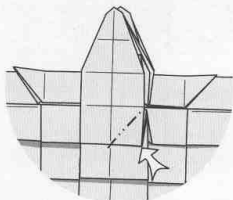

47. Hundir abierto.
Open-sink.

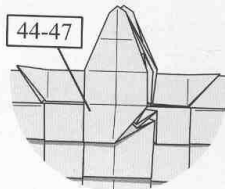

48.

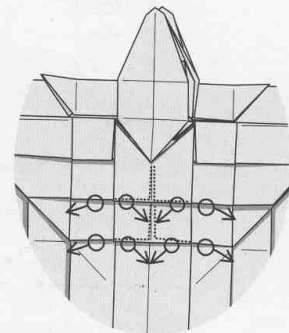

49. Separar las capas con cuidado.
Carefully pull the layers apart.



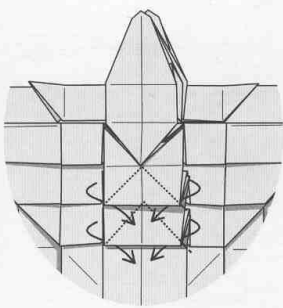

50. Revertir. Esto queda oculto.
Make four hidden reverse-folds.

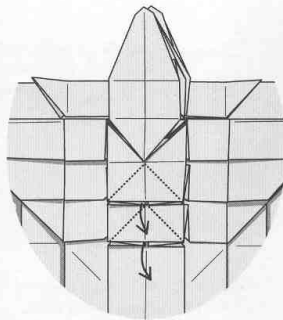

51. Formar dos puntas. Es similar al paso 30.
Form two points similarly to step 30.

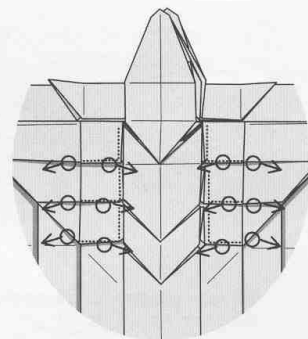

52. Separar las capas con cuidado.
Carefully pull the layers apart.

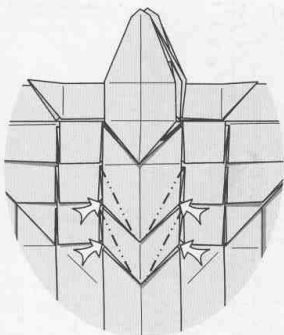

53. Hundir abierto.
Open-sink.

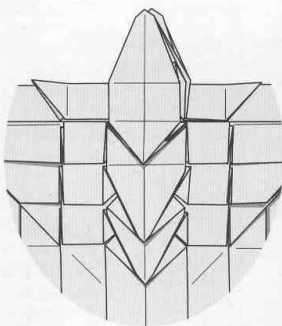

54.

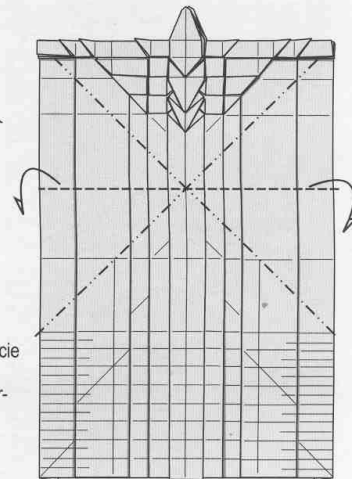

55. Doblar una especie
de bomba de agua.
Fold a kind of water-
bomb base.

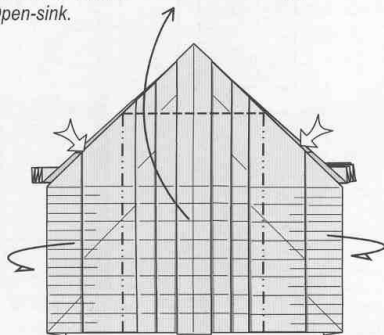

56. Doblar
en pétalo.
Petal-fold.

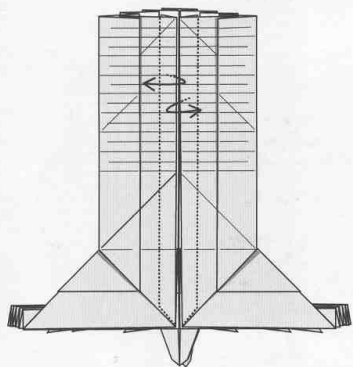

57. Sacar una franja de atrás y doblarla delante.
Take a strip from behind and fold it in front.

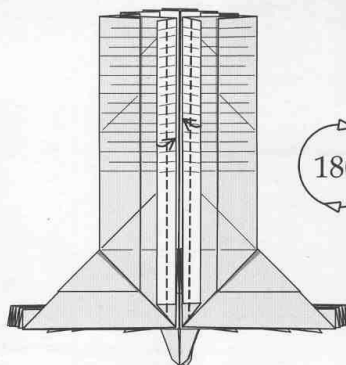

58. Doblar la franja a la mitad.
La marca viene del paso 12.
Valley-fold the strip in half. The
crease comes from step 12.

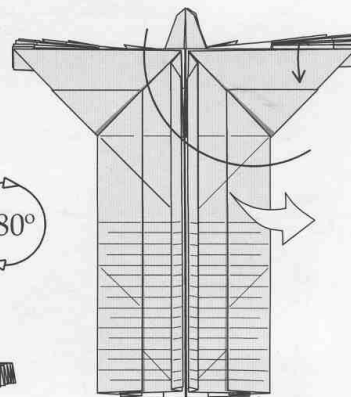

59. Abrir para trabajar en
el interior del ala.
Open slightly to work
inside the wing.



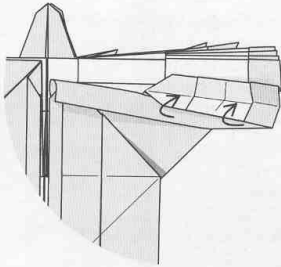

60. Pasar una capa hacia adelante.
Bring one layer on top.

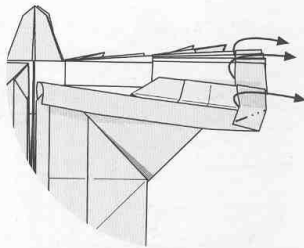

61. Desdoblar el último segmento del ala.
Unfold the last segment of the wing.

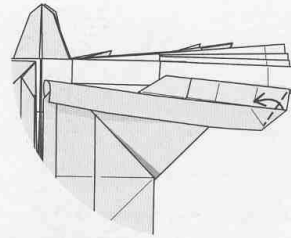

62. Doblar en valle.
Valley-fold.

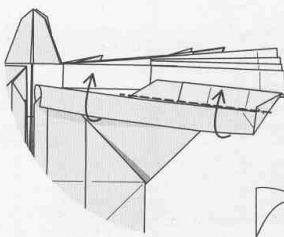

63. Cerrar nuevamente.
Close up again.

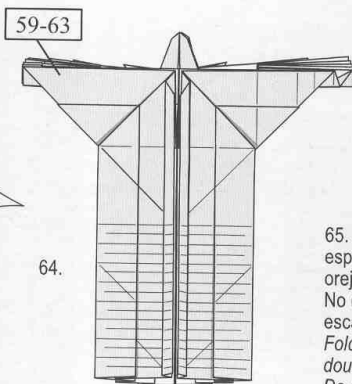

64.

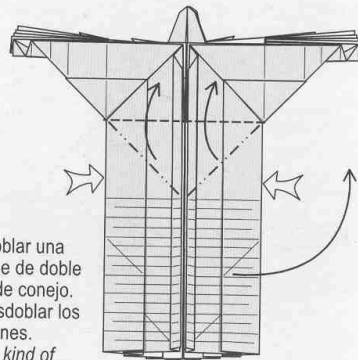

65. Doblar una especie de doble oreja de conejo. No desdoblar los escalones.
Fold a kind of double rabbit ear. Do not unfold the pleats.

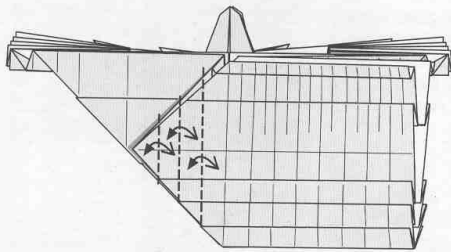

66. Marcar a través de todas las capas de esta aleta.
Crease through all the layers of this flap.

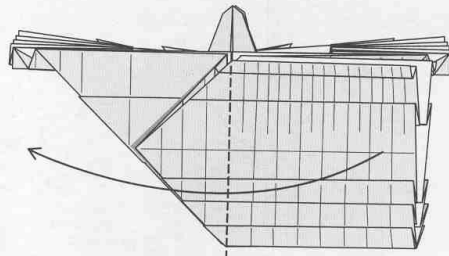

67. Doblar en valle.
Valley-fold.

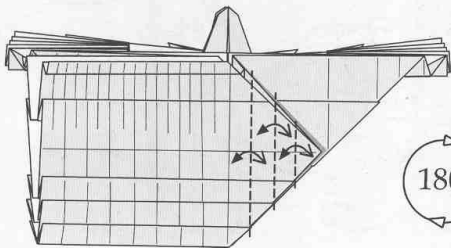

68. Marcar a través de todas las capas de esta aleta.
Crease through all the layers of this flap.

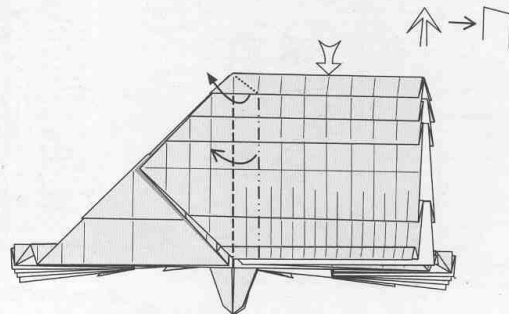

69. Abrir los pliegues de más arriba formando una figura de sección cuadrada.
Open the top pleats forming a square cross-section.



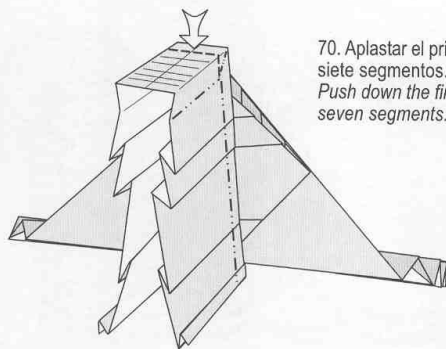

70. Aplastar el primero de siete segmentos.
Push down the first of the seven segments.

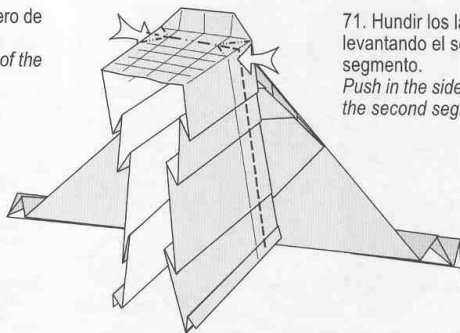

71. Hundir los lados levantando el segundo segmento.
Push in the sides, lifting up the second segment.

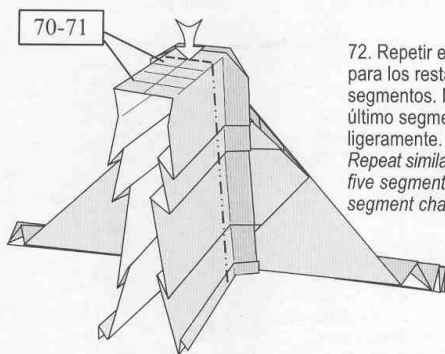

72. Repetir en forma similar para los restantes cinco segmentos. Notar que el último segmento cambia ligeramente.
Repeat similarly for the other five segments. Note the last segment changes slightly.

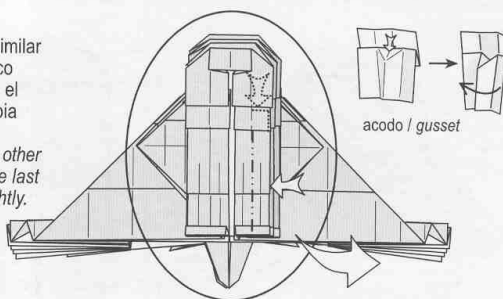

73. Hundir. Se debe hacer un acodo del lado interno.
Sink. A gusset has to be made on the inside.

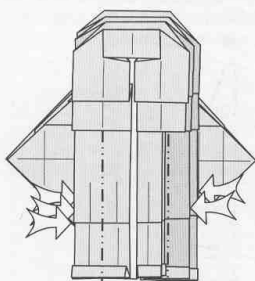

74. Hundir cinco bordes más.
Sink another five edges.

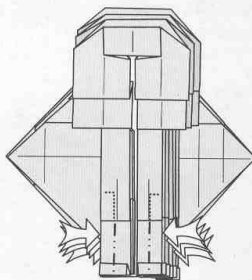

75. Hundir ocho bordes más. La maniobra es la misma que antes, pero con la mitad del ancho.
Sink another eight edges. The maneuver is the same as before, but with half the width.

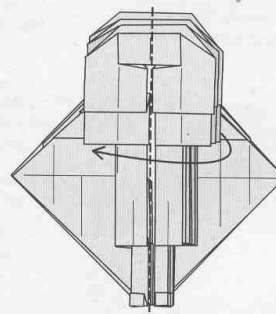

76. Doblar varios bordes en valle.
Valley-fold several edges.

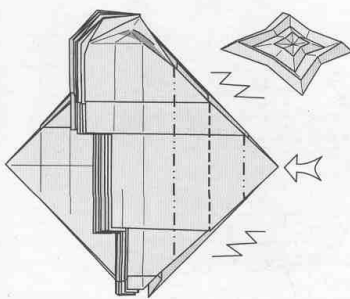

77. Hundir hacia adentro y hacia afuera, como si fuese una sola capa.
Sink in and out, as if it was a single layer.

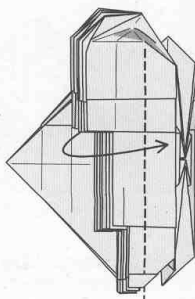

78. Devolver los bordes a su posición.
Bring the edges back to their original position.

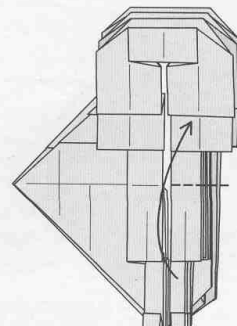

79. Doblar en valle.
Valley-fold.

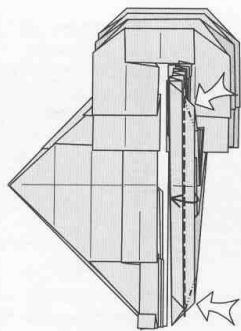

80. Doblar en valle aplastando en los extremos.
Valley-fold while spread-squashing at both ends.

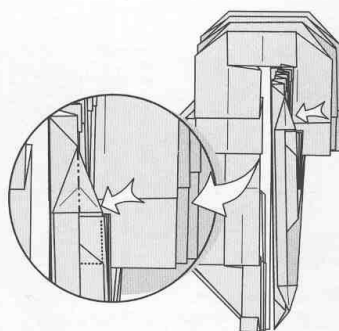

81. Hundir cerrado con un acodo por dentro.
Closed-sink, making a little gusset inside.

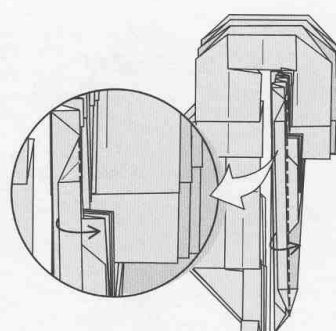

82. Doblar en valle.
Valley-fold.

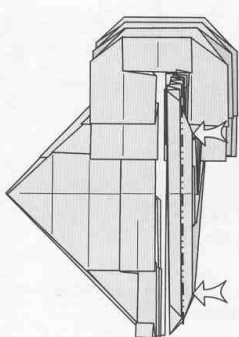

83. Hundir cerrado.
Closed-sink.

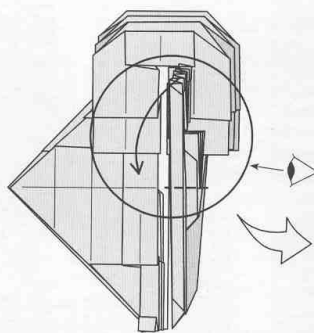

84. Abrir el abanico para trabajar en los dedos.
Fan out these layers to work on the toes.

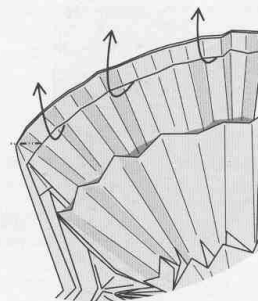

85. Desdoblar este borde. Una fina franja permanece doblada hacia atrás.
Unfold this edge. A thin strip will remain folded behind.

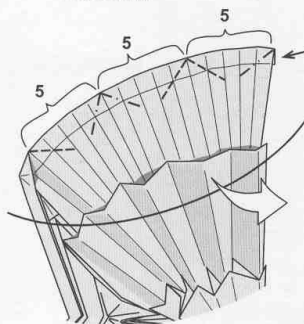

86. Marcar.
Crease.

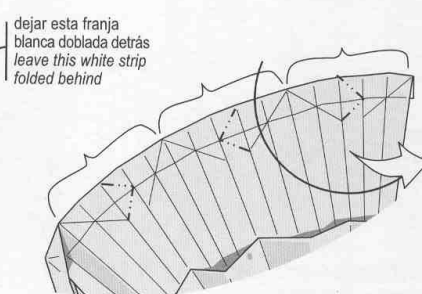

87. Marcar.
Crease.

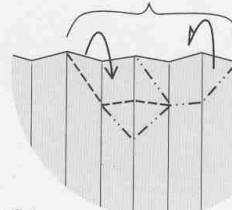

88. Colapsar.
Collapse.

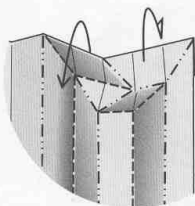

89. Paso intermedio.
Intermediate step.

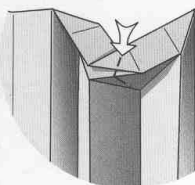

90. Al llegar a este punto, empujar para terminar de aplanar.
When you make it to this point, push down flattening.

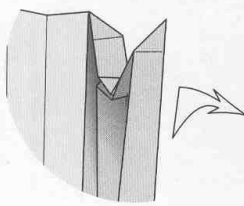

91.

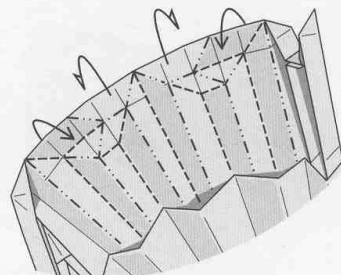

92. Repetir dos veces. Notar que cada dedo es una imagen especular del anterior.
Repeat twice. Note each toe is a mirror image of the previous one.



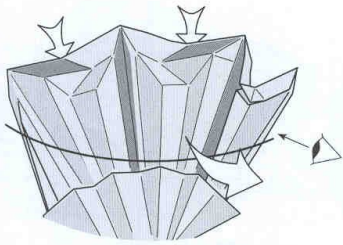

93. Paso intermedio.
Intermediate step.

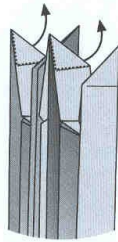

94. Sacar papel atrapado en dos dedos.
Release some trapped paper in two of the toes.

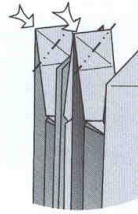

95. Marcar y hundir abierto.
Crease and open-sink.

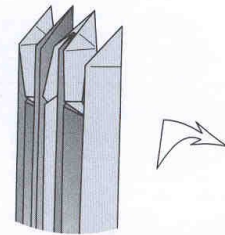

96. Volver a colocar las aletas en la posición del paso 79.
Put the flaps back as in step 79.

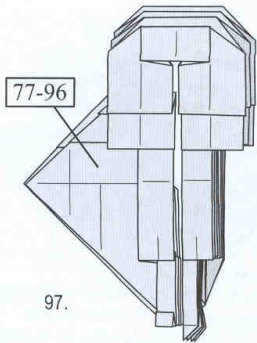

97.

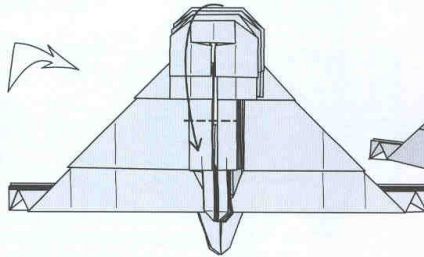

98. Doblar la cola para trabajar detrás.
Fold the tail down enough to work behind it.

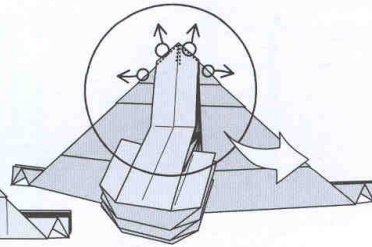

99. Cuidadosamente separar las capas.
Carefully spread the layers.

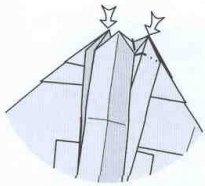

100. Hundir abierto.
Open-sink.

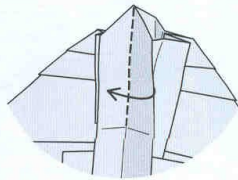

101. Doblar en valle sin aplanar.
Valley-fold. Do not flatten.

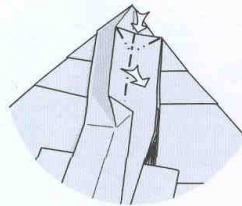

102. "Des-hundir" la zona que se muestra.
Un-sink the shown area.

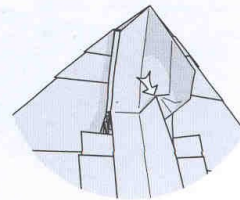

103. Hundir aplanando localmente.
Sink flattening locally.

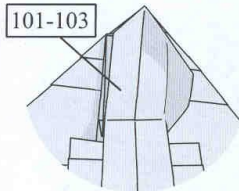

104.

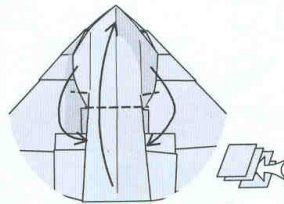

105. Cerrar la aleta nuevamente, metiendo dos aletas en bolsillos. Este debe trabar el cuerpo a la cola.
Close up this flap again tucking two edges into pockets. This should lock the body and tail together.

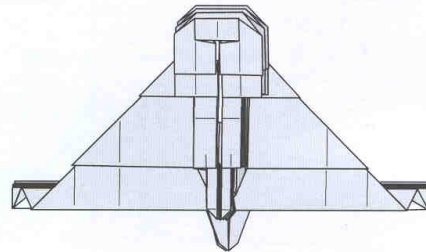

106. La base está pronta para comenzar con las terminaciones.
The base is now ready to start the finishing folds.



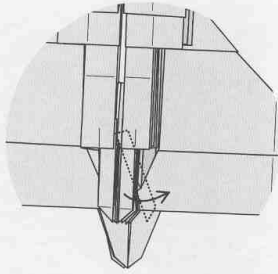

107. Hacer esta maniobra en cinco bordes que conforman cada pata.
Do this maneuver using five edges to form each leg.

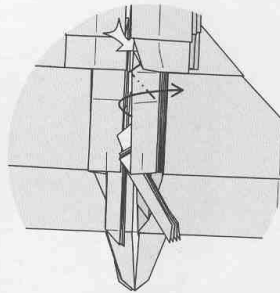
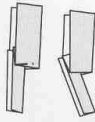

108. Abrir una capa.
Open a single layer.

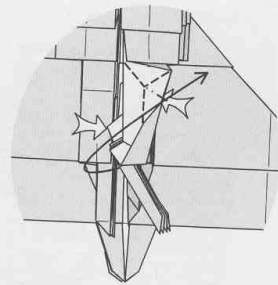

109. Doblar una oreja de conejo mientras se abre la parte trasera de la pata.
Make a rabbit ear while opening the back side of the leg.

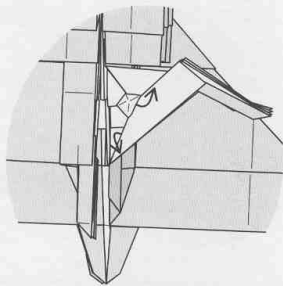

110. Liberar papel atrapado.
Release some trapped paper.

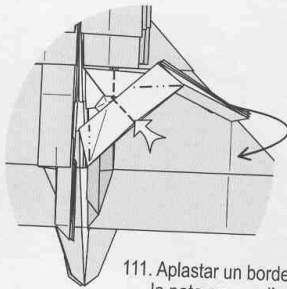

111. Aplastar un borde al tiempo que se coloca la pata perpendicularmente al cuerpo.
Squash an edge while placing the leg perpendicular to the body.

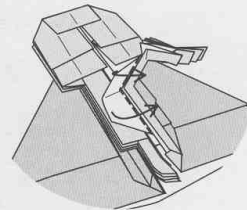

112. Doblar el borde blanco en valle sobre la pata.
Valley-fold the white edge over the leg.

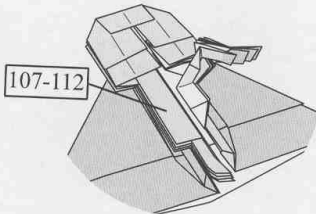

113.

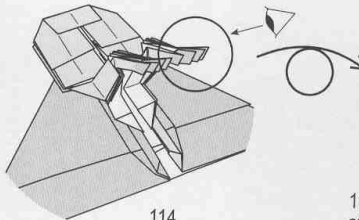

114.

115. Se muestra el detalle del afinado de los dedos.
These are the details for narrowing the toes.

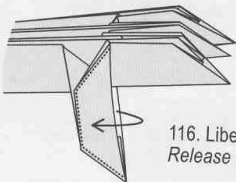

116. Liberar papel.
Release some trapped paper.

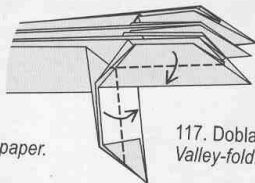

117. Doblar en valle.
Valley-fold.

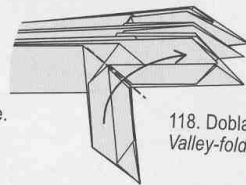

118. Doblar en valle.
Valley-fold.

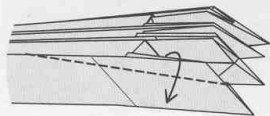

119. Doblar dos bordes en valle.
Valley-fold two edges.

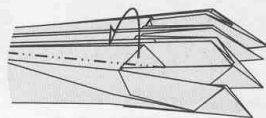

120. Doblar un borde en monte.
Mountain-fold one edge.

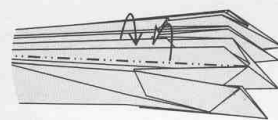

121. Doblar un borde en monte y el siguiente en valle.
Mountain-fold the first edge and valley-fold the next one.



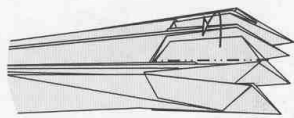

122. Doblar un borde en monte.
Mountain-fold one edge.

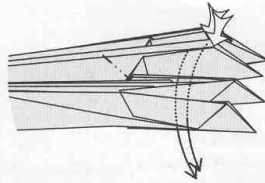

123. Hundir cerrado separadamente los dos bordes del tercer dedo.
Separately closed-sink the two edges that form the third toe.

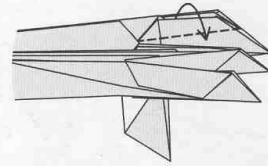

124. Doblar un borde en valle.
Valley-fold one edge.

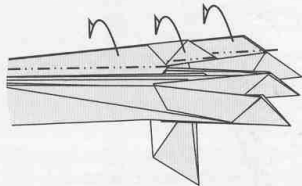

125. Doblar los bordes restantes en monte separadamente.
Mountain-fold the remaining edges separately.

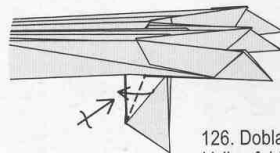

126. Doblar en valle.
Valley-fold.

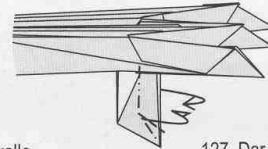

127. Dar forma.
Shape.

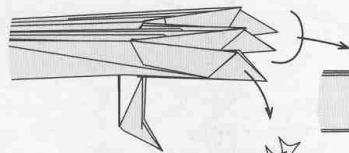

128. Formar las garras.
Shape the claws.

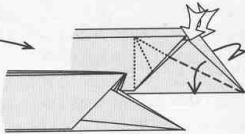

129.

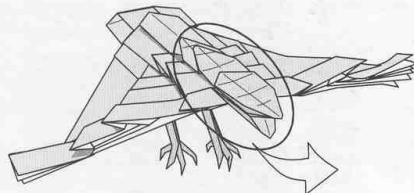

130.

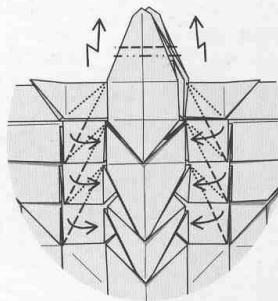

131. Escalonar el pico. Pivotar para formar seis plumas.
Crimp the beak. Swivel-fold to make six feathers.

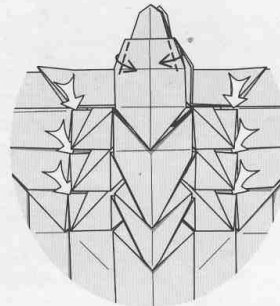

132. Levantar dos bordes para formar ojos. Revertir seis bordes en las plumas.
Lift two edges to make the eyes. Reverse-fold six edges at the feathers.

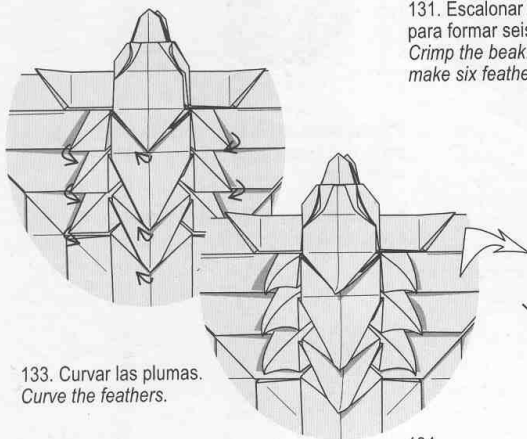

133. Curvar las plumas.
Curve the feathers.

134.

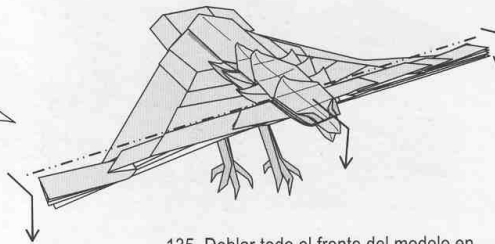

135. Doblar todo el frente del modelo en ángulo recto al resto.
Fold the whole of the front part of the model at right angles to the rest.



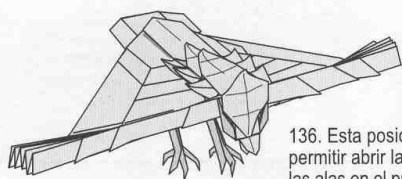

136. Esta posición va a permitir abrir las plumas de las alas en el próximo paso.
This position will allow you to fan out the wing feathers in the next step.

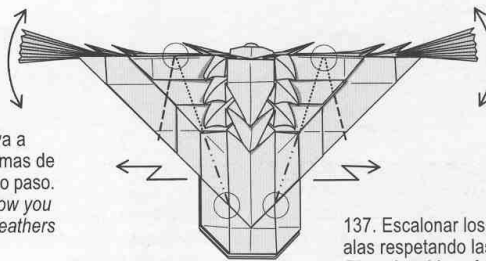

137. Escalonar los lados de las alas respetando las referencias.
Pleat the sides of the wings following these references.

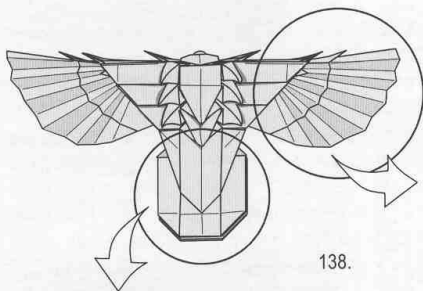

138.

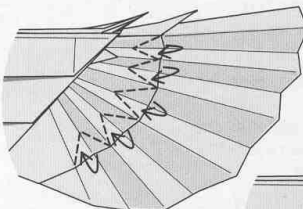

139. Revertir la segunda hilera de plumas de las alas.
Reverse-fold the second line of feathers on the wings.

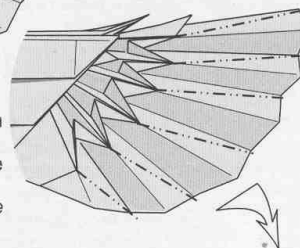

140. Estos dobleces en monte son sólo una de las posibles terminaciones para las plumas de las alas.
These mountain folds are just one of several possible finishings for the wing feathers.

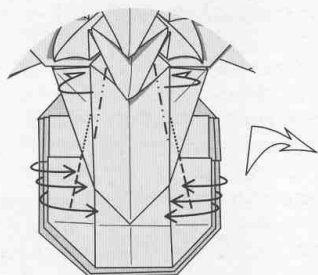

141. Doblar dos bordes en monte sobre el cuerpo. Formar las plumas de la cola levantando seis bordes.
Mountain-fold two edges on the body. Make the tail feathers by valley-folding six edges.

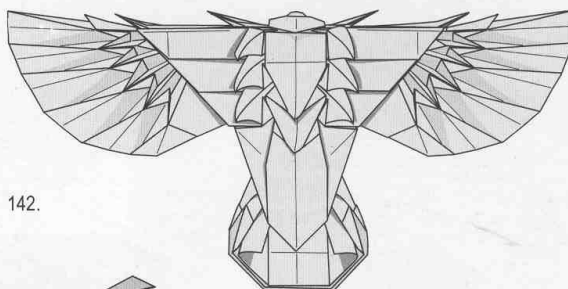

142.

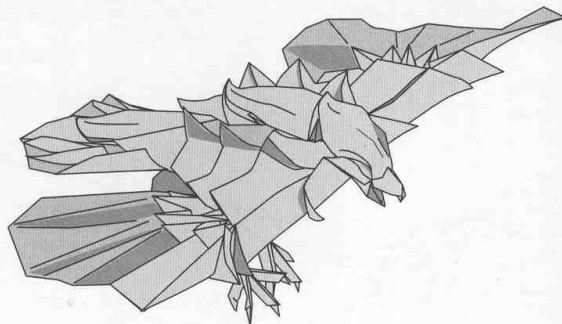

Resulta difícil incluir todo el moldeado de la figura por lo que buena parte quedará a cargo y gusto de cada plegador.

It is very hard to include all the shapings for this figure. Instead a good portion is left to the folder's taste.



RANA TRADICIONAL CHINA

TRADITIONAL CHINESE FROG

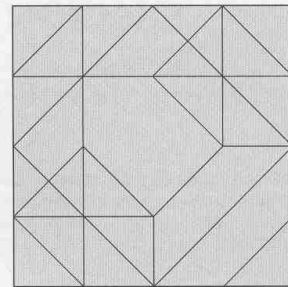
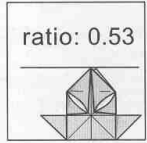
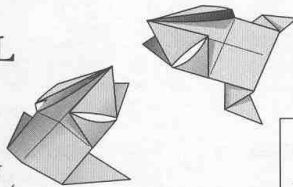

Nivel 1
Papel favorito: papel kami rojo y verde.
Tamaño recomendado: 10 a 15 cm.
Comentarios: doblar en seco.

Level 1
Favorite paper: green and red duocolor kami.
Recommended size: 10 to 15 cm.
Comments: dry-fold.

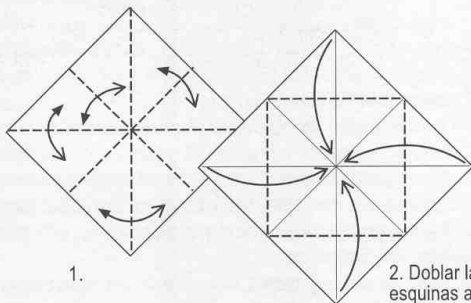

1.

2. Doblar las cuatro esquinas al centro.
Fold the four corners to the center.

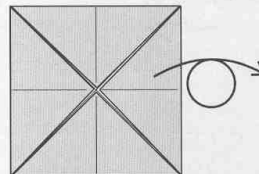

3.

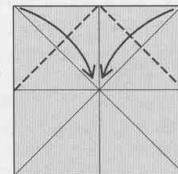

4. Doblar en valle.
Valley-fold.

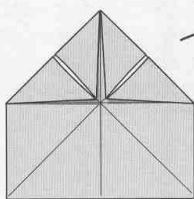

5.

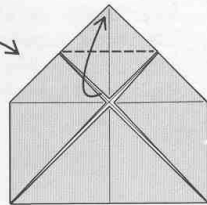

6. Doblar en valle.
Valley-fold.

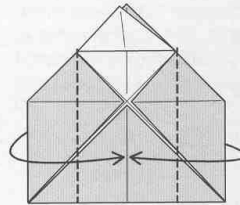

7. Doblar en valle.
Valley-fold.

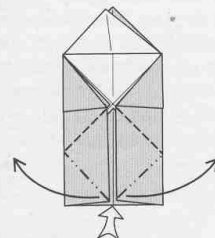

8. Abrir y aplastar.
Squash-fold.

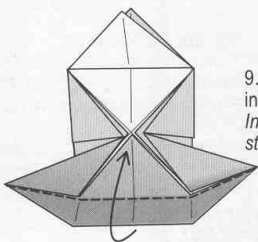

9. Paso intermedio.
Intermediate step.

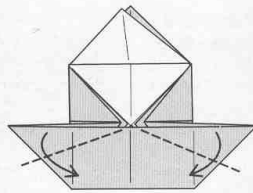

10. Doblar en valle.
Valley-fold.

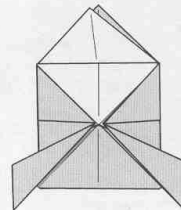

11.

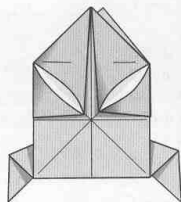

12.

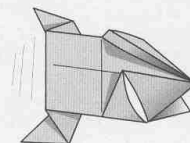
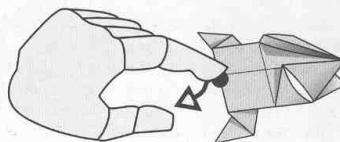

DOS VARIACIONES

TWO VARIATIONS

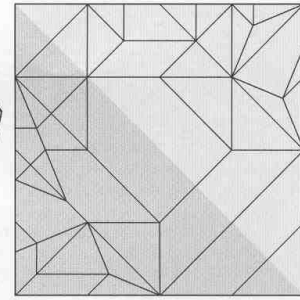
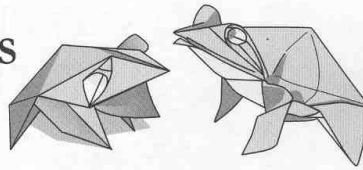

Rana / Sapo

Niveles: 2 / 2

Papeles favoritos: Kami verde y rojo /
Elefante pintado en una cara.

Tamaños recomendados: 15 cm / 20 cm.

Comentarios: doblar en seco / doblar en húmedo.

Frog / Toad

Levels: 2 / 2

Favorite paper: Green and red
duocolor kami / Elephant Hide,
painted on one side.

Recommended size: 15 cm / 20 cm.

Comments: dry-fold / wet fold.

ratio: 0.53

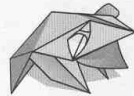
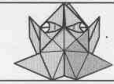

RANITA LITTLE FROG

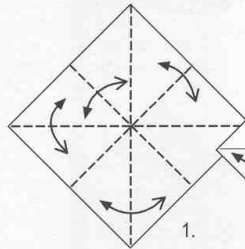

1.

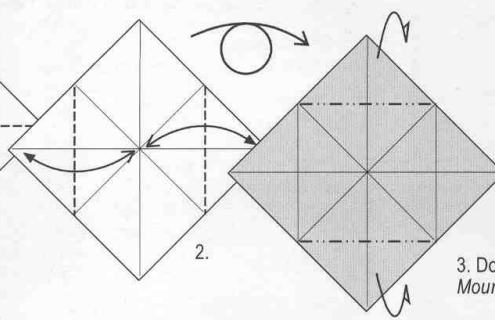

2.

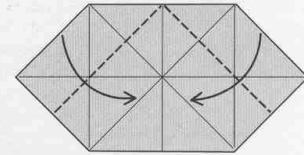

3. Doblar en monte.
Mountain-fold.

4. Doblar en valle.
Valley-fold.

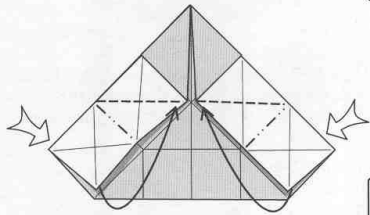

5. Pivotar dos esquinas.
Swivel the white corners
upwards.

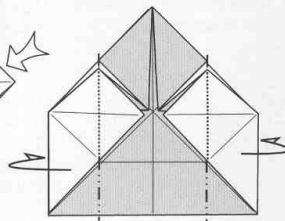

6. Doblar en valle permitiendo que las
esquinas sobresalgan.
Fold the sides backwards, letting the
white corners flip out.

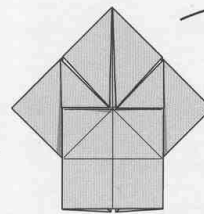

7.

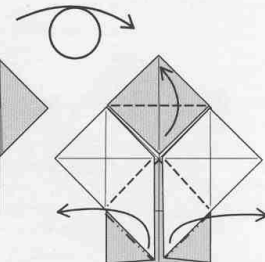

8. Doblar la boca y las patas
como en la rana tradicional.
Fold the mouth and the legs
as for the traditional frog.

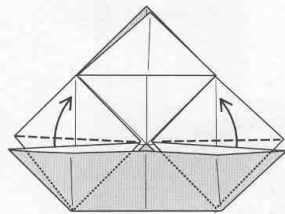

9. Liberar papel
atrapado...
Pull out some
trapped paper...

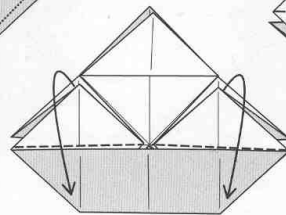

10. ...y doblarlo en valle.
...and fold it down.

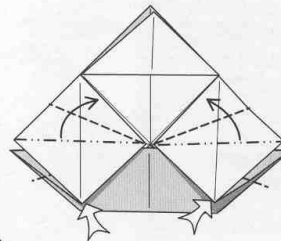

11. Pivotar.
Swivel-fold.

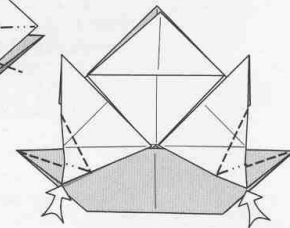

12. Pivotar.
Swivel-fold.



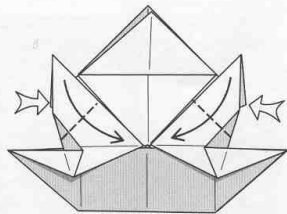

13. Doblar en valle mientras se aplasta una capa detrás.
Valley-fold the two front legs while squash-folding a layer behind.

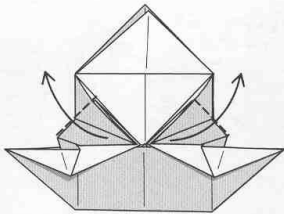

14. Doblar en valle.
Valley-fold.

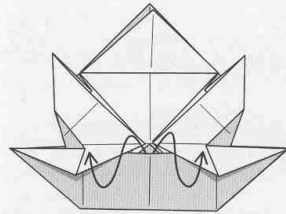

15. Tirar de la capa coloreada y colocarla delante.
Lift the colored layer up and bring it to the front.

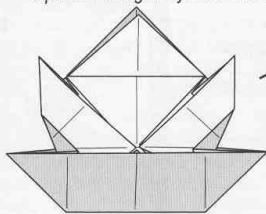

16.

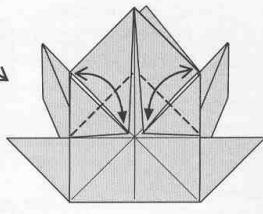

17. Marcar.
Crease.

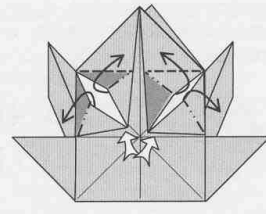

18. Abrir las capas.
Open the layers.

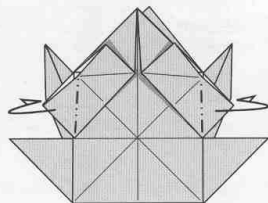

19. Meter un bolsillo.
Tuck the flaps into a pocket behind.

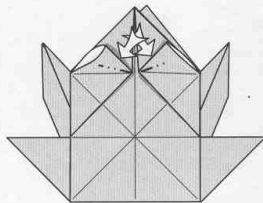

20. Aplastar formando los ojos.
Squash to form the eyes.

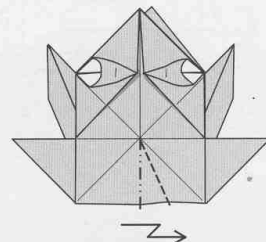

21. Escalonar marcando firmemente a través de todas las capas. No quedará plano.
Crimp-fold, creasing firmly through all layers. The frog will not lay flat.

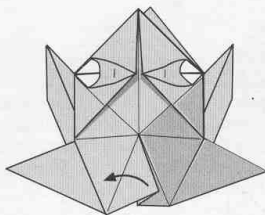

22. Desdoblar.
Unfold.

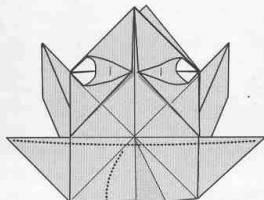

23. Abrir un borde desde atrás.
Partially open the rear end pulling a layer from underneath.

24. Empujar incorporando un doblez escalonado.
Push, forming a crimp in the middle of the paper.

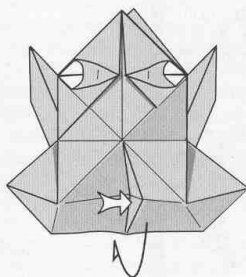
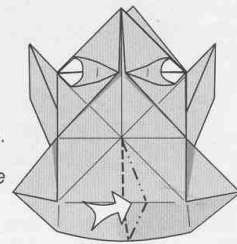

25. En proceso.
In progress.

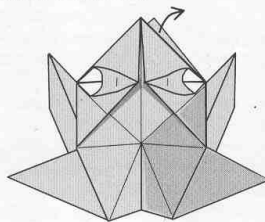

26. Abrir la boca y dar forma a gusto.
Open the mouth and shape further to taste.

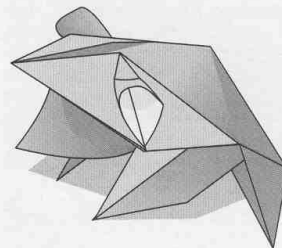

27.



SAPITO LITTLE TOAD

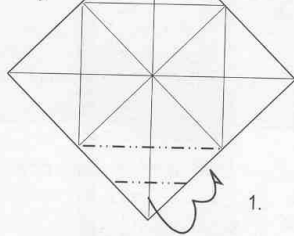
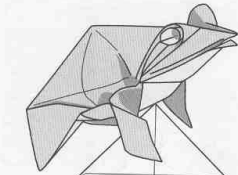

1.

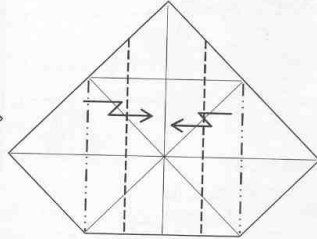

2. Escalonar.
Crimp-fold.

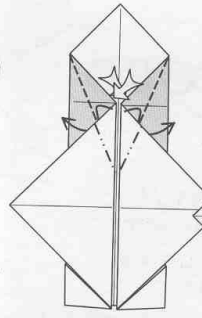

3. Marcar y revertir.
Pre-crease and
reverse-fold.

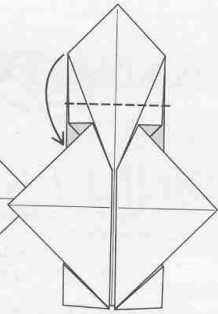

4. Doblar en valle.
Valley-fold.

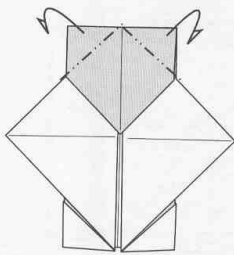

5. Doblar en monte.
Mountain-fold.

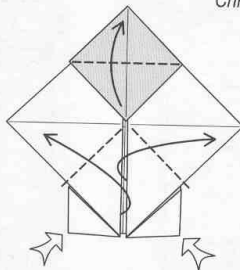

6. Pasos 8-11 de la ranita.
Steps 8-11 of the little frog.

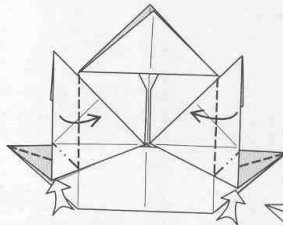

7. Pivotar todas las capas.
Swivel-fold all layers.

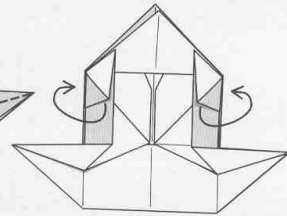

8. Envolver.
Wrap around.

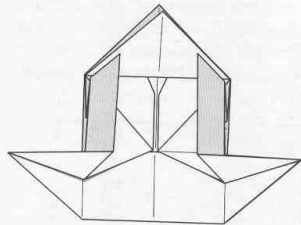

9. Pasos 15-16 y 21-26 de
la ranita.
Steps 15-16 and 21-26 of the
little frog.

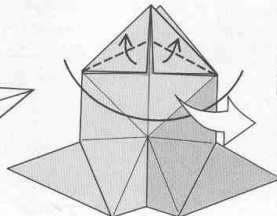

10. Doblar en valle.
Valley-fold.



11. Abrir sin aplastar del todo.
Squash-fold but do not flatten
all the way down.

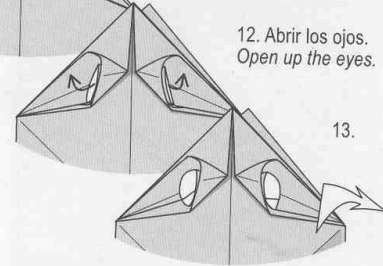

12. Abrir los ojos.
Open up the eyes.

13.

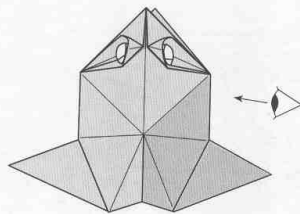

14.

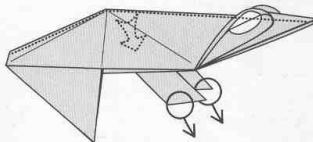

15. Tirar suavemente de las patas
para inflar las capas de la panza.
Gently pull the front legs to puff up
the belly.

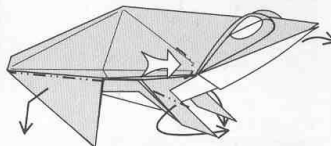

16. Algunas terminaciones.
Add some finishing touches.

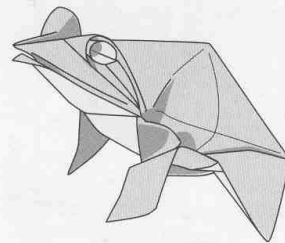

RANA TORO

BULLFROG

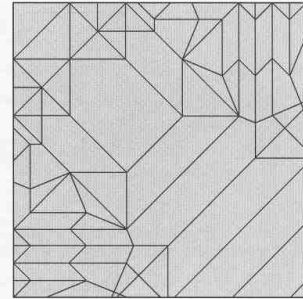
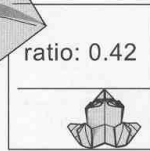
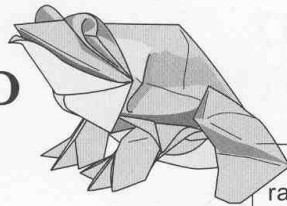

Nivel 3

Papel favorito: Elefante color verde pintado de blanco o verde más claro en una cara.

Tamaño recomendado: 24 cm.
Comentarios: doblar en húmedo.

Level 3

Favorite paper: green Elephant Hide painted white or a lighter green on one side.

Recommended size: 24 cm.
Comments: wet-fold.

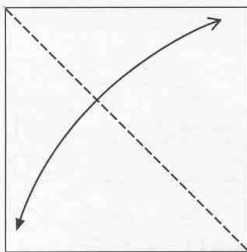

1.

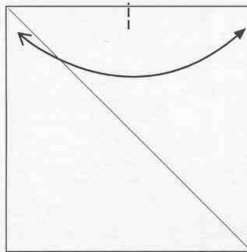

2.

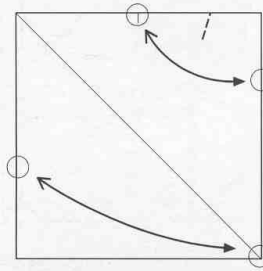

3. La esquina inferior toca el borde izquierdo mientras el borde derecho toca la marca. Hacer sólo una marca en el borde superior.
The bottom right corner touches the left edge while the right edge touches the previous crease. Only make a pinch on the top edge.

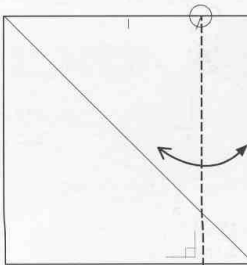

4. Marcar.
Crease.

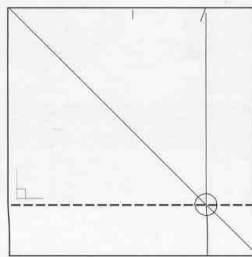

5. Marcar.
Crease.

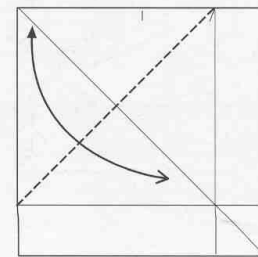

6. Marcar.
Crease.

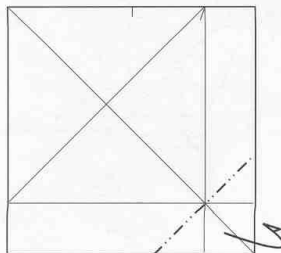

7. Doblar en monte.
Mountain-fold.

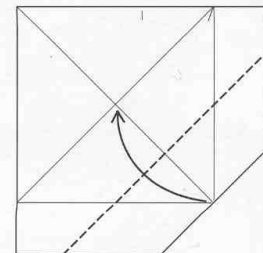

8. Doblar en valle.
Valley-fold.

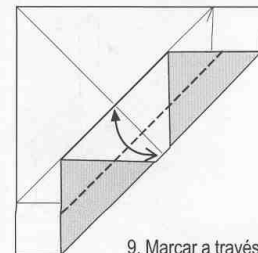

9. Marcar a través de dos capas.
Crease through two layers.



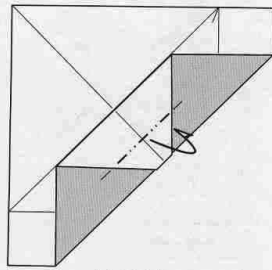

10. Doblar en monte.
Mountain-fold.

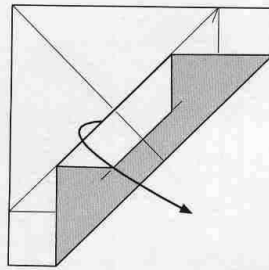

11. Desdoblar.
Unfold.

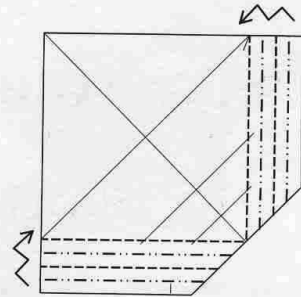

12. Dividir en cuatro y escalonar.
Pleat the edges into quarters.

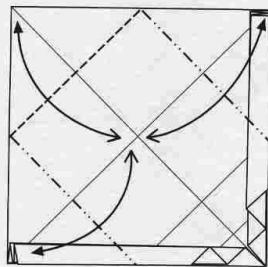

13. Marcar a través de todas las capas.
Crease through all layers.

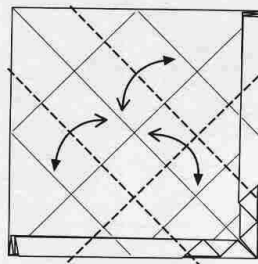

14. Marcar a través de todas las capas.
Crease through all layers.

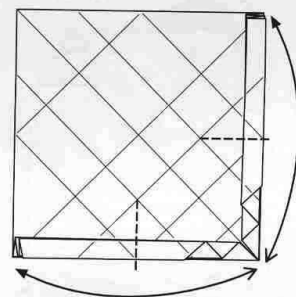

15. Marcar a través de todas las capas.
Crease through all layers.

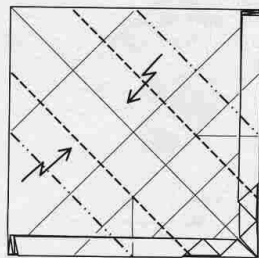

16. Escalonar.
Crimp-fold.

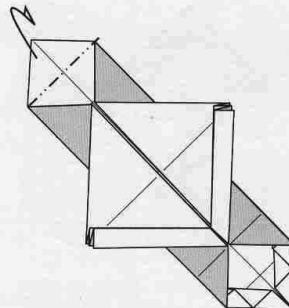

17. Doblar en monte.
Mountain-fold.

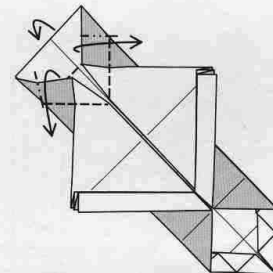

18. Abrir y aplastar.
Squash-fold.

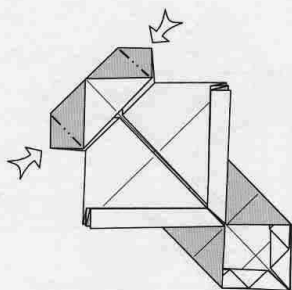

19. Revertir.
Reverse-fold.

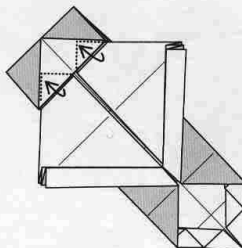

20. Liberar papel atrapado.
Release some trapped paper.

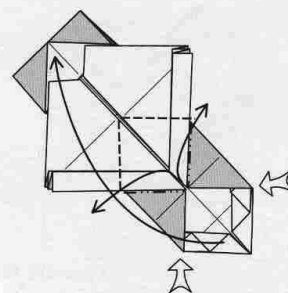

21. Abrir y aplastar con cuidado.
Squash-fold carefully.



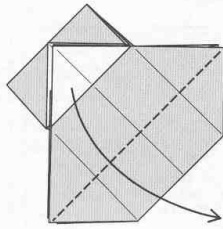

22. Doblar en valle.
Valley-fold.

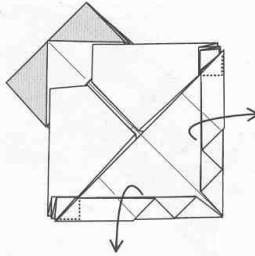

23. Doblar este grupo de bordes liberando papel en los lados.
Valley-fold this group of edges releasing some paper at the corners.

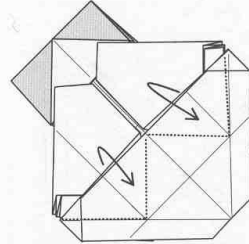

24. Traer estas aletas hacia adelante.
Bring these flaps to the front.

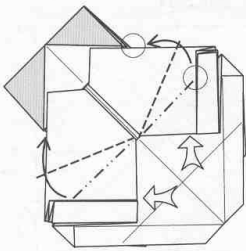

25. Abrir y aplastar.
Squash-fold.

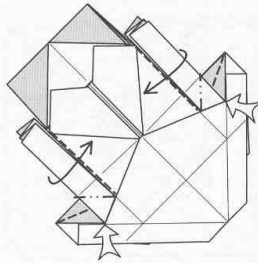

26. Pivotar.
Swivel-fold.

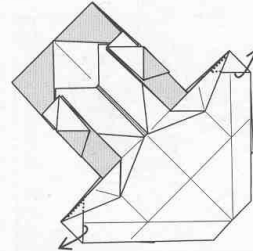

27. Liberar papel atrapado.
Release some trapped paper.

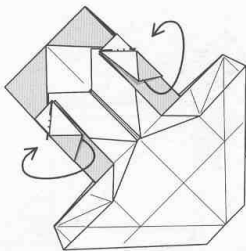

28. Envolver un borde con cuidado. Las capas de la pata quedarán encerradas.
Wrap one edge around very carefully. The layers of the leg will end up mountain folded inside the flap.

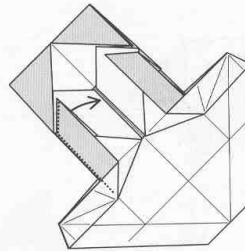

29. Liberar un abanico de capas.
Release the layers and fan them out.

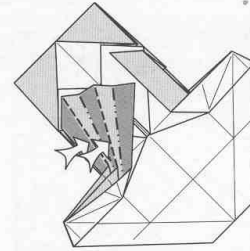

30. Hundir dos bordes separadamente.
Sink two edges separately.

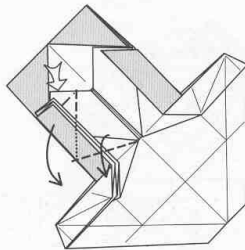

31. Doblar la pata en valle mientras se aplasta una esquina detrás.
Valley-fold the leg while squash-folding a corner behind.

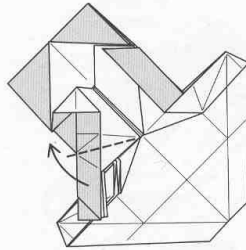

32. Doblar en valle.
Valley-fold.

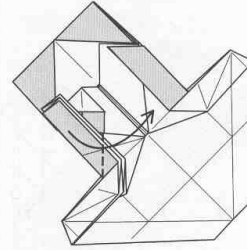

33. Doblar en valle aplastando una esquina detrás. Estas marcas se utilizarán en el paso 64.
Valley-fold, squash-folding a corner behind. These creases will be needed in step 64.



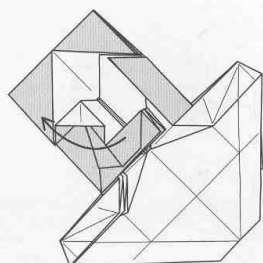

34. Desdoblar al paso 33.
Unfold to step 33.

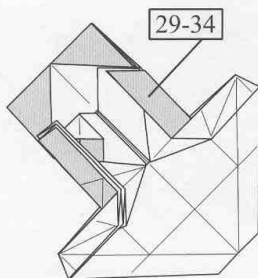

35.

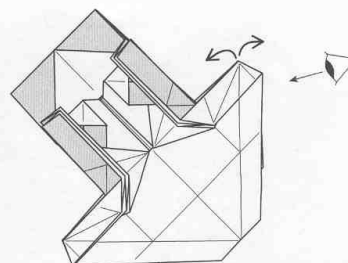

36. Con mucho cuidado separar las capas.
Se debe abrir bastante la figura para no rasgar el papel.
*Very carefully separate these layers.
The paper needs to be opened quite a bit so that it does not tear.*

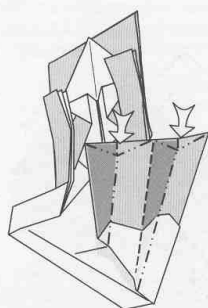

37. Hundir e invertir la dirección de los dobleces.
Press here and change the direction of the pleats.

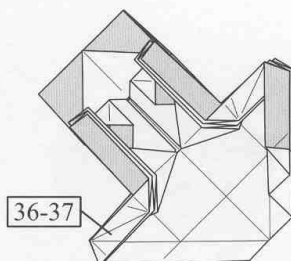

38.

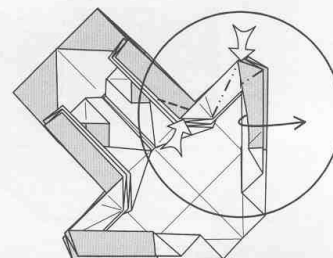

39. Abrir una capa mientras se pivota una esquina.
Open one layer while swivel-folding a corner.

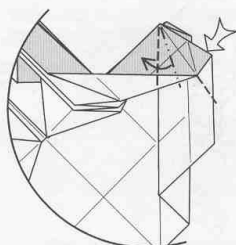

40. Abrir y aplastar.
Squash-fold.

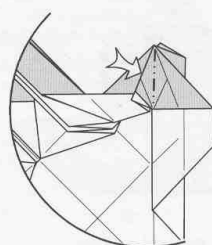

41. Revertir metiendo debajo de otra capa.
Reverse-fold tucking under a layer.

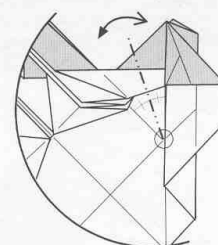

42. Marcar firmemente a través de todas las capas.
Crease firmly through all layers.

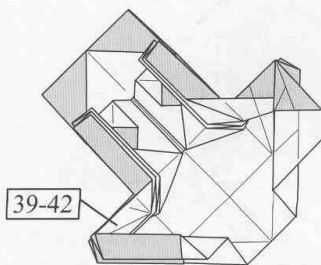

43.

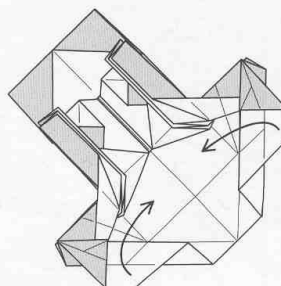

44. Doblar en valle.
Valley-fold.

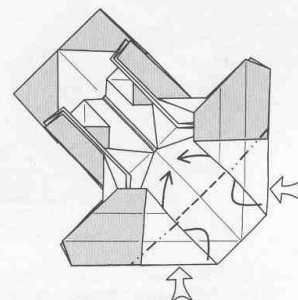

45. Revertir dos esquinas a un tiempo.
Reverse-fold two corners at the same time.



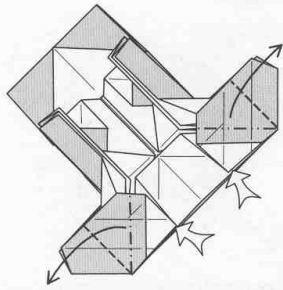

46. Abrir y aplastar.
Squash-fold.

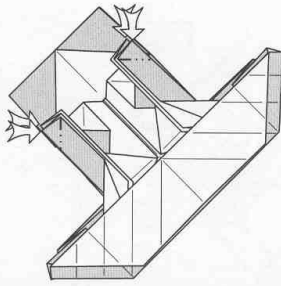

47. Revertir cuatro esquinas.
Reverse-fold four corners.

45°

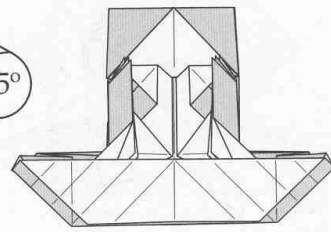

48.

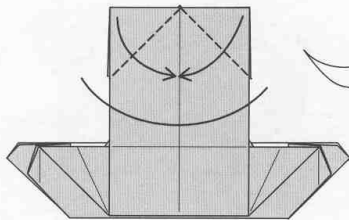
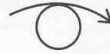

49. Doblar en valle.
Valley-fold.

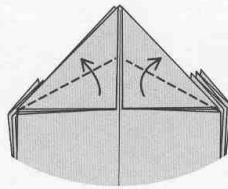

50. Doblar en valle.
Valley-fold.

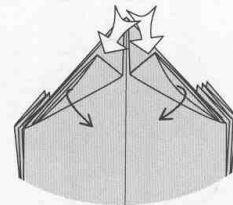

51. Abrir sin aplastar formando una especie de pirámide para los ojos.
Spread-squash-fold but do not flatten. Make a kind of pyramid for the eye.

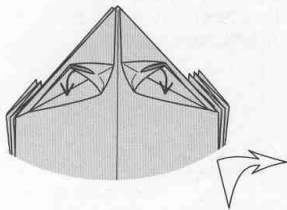

52. Dar forma.
Further shape.

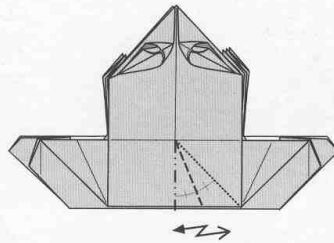

53. Marcar firmemente a través de todas las capas.
Crease firmly through all layers.

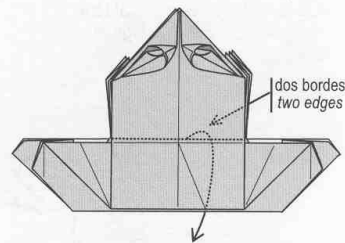

54. Encontrar dos bordes detrás y **abrir ambos** hacia abajo.
*Find two edges behind and **open both** downwards.*

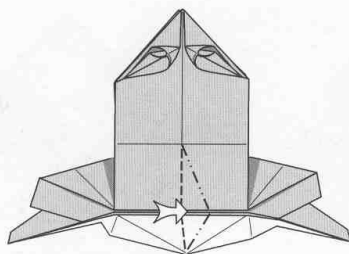

55. Empujar para hacer un escalonado a través de todas las capas.
Push to make a crimp-fold through all layers.

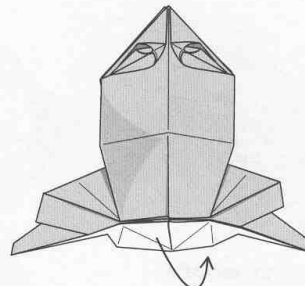

56. Una vez que todas las capas estén en el pliegue, regresarlas todas a su lugar aplanando localmente.
Once you have all of the layers inside the crimp, push the paper back to its initial position under the model, flattening locally.



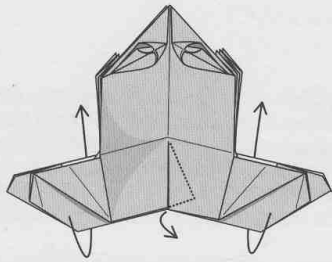

57. Identificar un borde blanco y uno de color que se desenganchan fácilmente del doblado anterior. Abrir esos dos bordes hacia adelante. *Identify one white and one colored edge that can easily be disengaged from the previous fold. Open them both towards the head.*

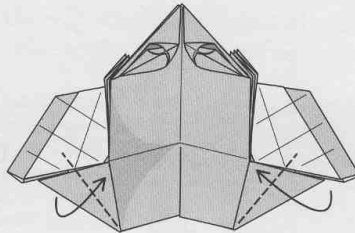

58. Doblar en valle sólo donde se muestra. *Valley-fold only where shown.*

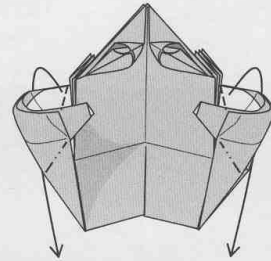

59. Sujetar el doblado anterior en su lugar mientras se regresan las dos capas de abajo a su lugar. *Hold the previous fold in place while returning the two layers below to their starting place, but do not tuck the layers released in step 57 back in yet.*

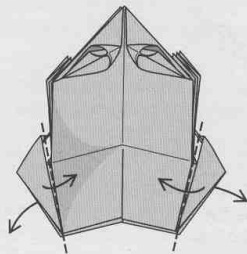

60. Doblar en valle permitiendo que las patas roten hacia afuera. *Valley-fold allowing the legs to swing out from below.*

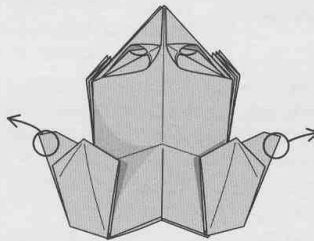

61. Tirar de las patas dando forma a gusto. *Pull the legs out and shape them to taste.*

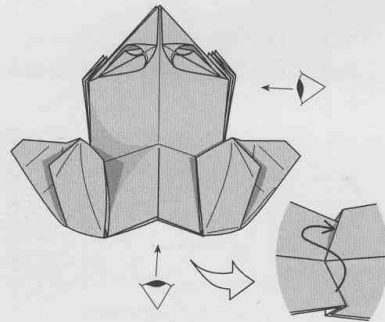

62. Enganchar en su lugar las capas que se liberaron en el paso 57. *Tuck the layers that were released in step 57 back into the pocket.*

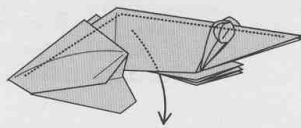

63. Tirar suavemente de las patas delanteras separando las capas para dar volumen al modelo. Si este paso resulta imposible, probablemente de deba a un error en el paso 54. *Pull the front legs to separate the layers and puff up the model. If this is not possible it is probably due to a mistake in step 54.*

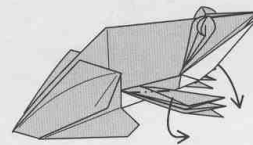

64. Colocar las patas en posición siguiendo marcas del paso 33. *Position the legs using the creases from step 33.*

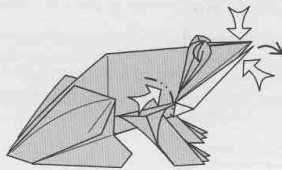

65. Empujar los costados justo detrás de la cabeza para dar forma y más volumen. Dar forma a la boca. *Push the sides, right behind the head, to shape and give the body more volume. Shape the mouth.*

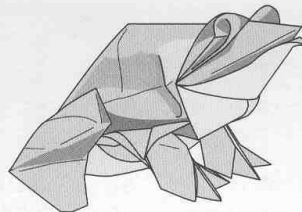

66.

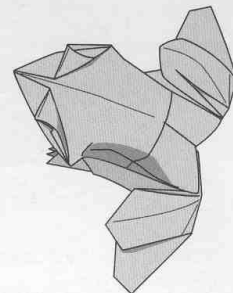

Learn about the essence of origami by following clear step by step instructions for folding the most sought-after works by acclaimed Uruguayan Master Román Díaz. More than thirty models for all abilities, from the most simple to the most advanced origami you can find. Learn how to fold the Bullfrog, the Fox and the Unicorn, and discover the fun of inflatable origami. Find the true meaning behind the ancient art of paper folding through Román's techniques and his beautiful animal designs.

Descubra el increíble arte del origami siguiendo instrucciones claras, paso por paso, para plegar los trabajos más requeridos del aclamado Maestro uruguayo Román Díaz. Más de treinta modelos para todos los niveles, desde simple hasta el origami más avanzado que pueda encontrarse. Aprenda a plegar la Rana Toro, la Zorra y el Unicornio, encuentre el placer del origami inflable, sienta la esencia del antiguo arte del papel plegado a través de las técnicas modernas y bellos diseños de animales.



32,00 €



ISBN 2-84424-063-1



<http://www.passionorigami.com>